

HP Archive

This vintage Hewlett Packard document was preserved and distributed by
www.hparchive.com
Please visit us on the web !

On-line curartor: Glenn Robb

1956

ALFRED CROSSLEY ASSOCIATES, INC.
Midwest Sales Engineers
53 Park Avenue
Dayton 9, Ohio
Phone: OXmoor 3594

**SUPPLEMENT TO CATALOG 22-A
1956**



**ELECTRONIC TEST
INSTRUMENTS**

HEWLETT-PACKARD COMPANY | 275 PAGE MILL ROAD, PALO ALTO, CALIFORNIA, U. S. A.



130A LOW FREQUENCY OSCILLOSCOPE



Advantages:

- Extreme operating dependability
- Brilliant, high resolution trace
- Automatic triggering system
- Sensitivity 1 mv per centimeter
- High gain, balanced input
- 21 calibrated sweeps; direct reading
- Wide pass band, dc to 300 KC
- Similar X and Y amplifiers
- Twist-off bezel; easy CRT change
- High stability, unique versatility
- Etched, unitized circuits

Use To Measure:

Provides new convenience in evaluating complex voltages. Particularly ideal for measuring mechanical quantities through a transducer such as complex voltages, stress, strain and vibration, pressure and displacement, acceleration, etc.

Most Dependable Oscilloscope Offered Commercially

HERE AT LAST is a new kind of oscilloscope—actually the first commercial instrument to combine three basic features you want most—broad usefulness, simple operation, and the degree of dependability you expect from time-tested *-hp-* instruments. *-hp-* 130A provides each of these advantages, and sets new standards for oscilloscope usefulness, simplicity and reliability.

Covering frequencies from dc to 300 KC, *-hp-* 130A is a versatile, all-purpose tool for laboratory, production line and industrial processing measurements. In addition to its versatility as an oscilloscope, *-hp-* 130A can be used as a millivoltmeter or voltmeter.

Simple operation is an outstanding characteristic of the new instrument. Controls are at a minimum, are color-coded to front panel markings and are arranged by function. 21 sweep times may be directly set on the panel control; no arithmetic or interpolation is required to determine sweep settings. Horizontal sweeps are calibrated from 1 μ sec/cm to 5 sec/cm. Accuracy is within 5%, and sweeps are highly linear.

Automatic Triggering

Two novel circuit features contribute to the instrument's unique operating convenience. First, the oscilloscope accepts signals direct from conventional transducers without preamplification in the majority of cases. Findings are presented in a brilliant, high resolution trace visible under all lighting conditions. Second, the instruments contain a "universal" automatic triggering system. Under almost all circumstances, one single preset condition provides optimum triggering. The sweep may be operated free-running when it is desired to determine the base line. A high degree of stability and freedom from horizontal jitter is maintained under all sweep conditions.

Similar X, Y Amplifiers

Horizontal and vertical amplifiers are similar, and provide high sensitivity of 1 mv/cm or 10 mv full scale deflection. The amplifiers have wide pass bands from dc to 300 KC, and offer balanced input circuits on the five most sensitive ranges. (These circuits are particularly useful in industrial, medical and similar applications where it is more convenient to accept a low level balanced signal direct from a transducer.) The amplifiers also provide single ended input, and may be either ac or dc coupled.

Use as Voltmeter

Both amplifiers on the *-hp-* 130A are highly stable, requiring virtually no adjustment during operation. Their gain may be standardized by an internal 1,000 cycle 10 millivolt source. These features, together with the instrument's precision input attenuator, make possible use of the oscilloscope as a millivoltmeter or voltmeter accurate within 5%.

Quick CRP Interchange

-hp- 130A is arranged physically for maximum convenience in use. In addition to concentric, color-coded controls, a tilt bail is provided to raise the instrument to a suitable viewing angle. The CRT bezel removes instantly with 15° rotation, simplifying changing of tubes and filters. (The bezel also provides a firm mount for standard oscilloscope camera equipment.) An alignment lever provides quick and direct orientation of the CRT trace with the graticule.

Etched Circuitry

Electrically and electronically, the design of Model 130A is highly conservative. Components are operated well below ratings. Etched circuitry is used extensively to stabilize capacities and increase operating dependability and accessibility. The entire instrument is broken down into several sub-assemblies, each functionally integral and readily reachable for servicing.

Specifications

Sweep

Range: 1 μ sec/cm to 15 sec/cm.

Calibrated: 21 calibrated sweeps in 1-2-5-10 sequence, 1 μ sec/cm to 5 sec/cm. Accuracy within 5%.

Vernier: Permits continuous adjustment of sweep time.

Triggering: Internally, line voltage, or externally with 2 v or more.

Trigger Point: Any positive or negative level on the positive or negative slope of the signal triggering the sweep. +30 to -30 volt range for external trigger.

Preset Triggering: Switch position on sweep mode control automatically selects optimum setting for stable triggering.

Input Amplifiers

Vertical and horizontal amplifiers have same characteristics.

Sensitivity Range: 1 mv/cm to 50 v/cm.

Input Attenuator: 14 calibrated ranges, in a 1-2-5-10 sequence, 1 mv/cm to 20 v/cm. Vernier permits continuous adjustment between ranges.

Pass Band: dc to 300 KC, independent of attenuator setting.

Coupling: ac or dc.

Balanced Input: On 1, 2, 5, 10 and 20 mv/cm ranges. Input impedance 2 megohms shunted with 25 μ mf.

Single Ended Input: On all ranges. Input impedance 1 megohm shunted with 50 μ mf.

Undistorted Deflection: Three screen diameters.

Amplitude Calibrator: Fixed amplitude, accuracy within 5%. Approximately 1 KC square wave.

General

Illuminated Graticule: Edge lighted graticule with controlled illumination, 10 cm x 10 cm, marked in centimeter squares with 2 mm subdivisions on major horizontal and vertical axes.

CRT Bezel: CRT bezel readily removed by a 15° twist, providing rapid means of changing filters and replacing cathode ray tube if different phosphors are required. Bezel locks to provide firm mount for standard oscilloscope camera equipment.

CRT Plates: Direct connection to deflecting plates via terminals on rear.

Intensity Modulation: Terminals on rear; 20 v positive signal blanks CRT at normal intensity.

Cathode Ray Tube: 5AQP mono-accelerator flat face type with 3000 volt accelerating potential. Available with P1, P7, or P11 screen.

Size: Width—9 $\frac{3}{4}$ " ; Height—15 $\frac{1}{4}$ " ; Depth—20".

Weight: 39 lbs net.

Power Supply: 115/230 volts \pm 10%, 50/400 cycles, approximately 175 watts.

Filter: Color of filter compatible with screen phosphor.

Price: \$450.00 f.o.b. Palo Alto, California. (Normally supplied with P1 screen. When ordering with P7 screen, specify 130A-7. When ordering with P11 screen, specify 130A-11.)

Data subject to change without notice.



150A HIGH FREQUENCY OSCILLOSCOPE

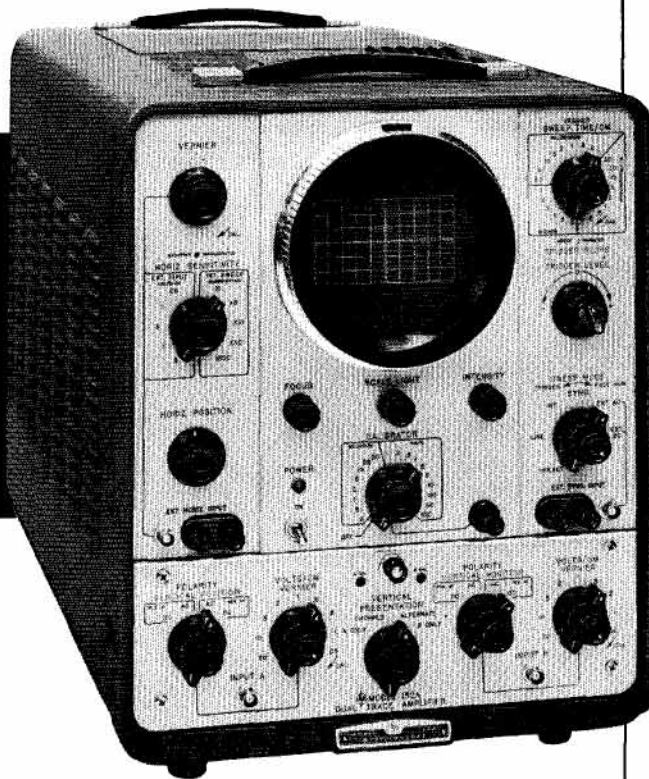

Advantages:

- Maximum usefulness, reliability
- Brilliant, full screen high resolution trace
- No halo or bloom effect
- Leading edge of signal always visible
- 24 direct reading calibrated sweeps
- Automatic sweep triggering
- 0.25 μ sec distortionless delay line
- Plug-in vertical pre-amplifiers, single or dual trace
- New pen-sized low capacity probe
- Sweep magnification of 5, 10, 50 and 100 x
- Single shot sweep with lock-out
- Twist-off bezel; CRT access door
- Etched circuits, unitized construction
- Color-coded, concentric controls, simplified and functionally grouped

Uses:

General purpose laboratory instrument for fast circuit work in pulse applications such as radar, TV, nucleonics and guidance systems. Presents the ultimate in waveform observation and complex voltage measurement.

Setting New Standards of Oscilloscope Dependability!

MAXIMUM usefulness, convenience, and utmost electrical and mechanical dependability—these were the objectives in designing the new *-hp-* 150A Oscilloscope. The result is a high frequency instrument which answers more laboratory and production problems more conveniently than previous equipment, and is the industry's most outstanding oscilloscope value.

For maximum usefulness, *-hp-* 150A is designed for operation with plug-in vertical amplifiers. Currently, these include *-hp-* 151A, a high gain unit with 5.0 mv/cm maximum sensitivity and frequency response from dc to 10 MC; and *-hp-* 152A, a dual amplifier permitting two phenomena to be presented on the CRT simultaneously. Either of *-hp-* 152A's dual amplifiers may be used separately. For dual trace presentation, an electronic switch applies amplifier outputs to alternate traces, or switches outputs at a 100 KC rate.

0.25 Microsecond Delay Line

The oscilloscope's vertical amplifier provides excellent transient response and less than 0.035 μ sec rise time; the pass band is dc to 10 MC. A distortionless 0.25 μ sec delay line permits viewing the leading edge of the signal triggering the sweep, and requires no adjustment. A single, direct reading front panel control selects any of 24 calibrated sweep times. No calculation or interpolation is required. Sweep times are accurate within 3% and cover the range 0.02 μ sec/cm to 5 sec/cm. The sweep may be triggered by internal or external voltage, or may be free running. Triggering may be accomplished on positive or negative slopes and at positive or negative voltages of +30 to -30 v.

Sweep Magnification

Model 150A's horizontal amplifier provides sweep magnification of 5, 10, 50 and 100 times, and a multi-turn positioning control provides a fine degree of horizontal adjustment so that any 10 cm portion of the magnified scale may be examined. Indicating lamps show when the magnification circuit is in use, or when a combination of sweep time and magnification exceeds the fastest calibrated sweep time. The horizontal amplifier, which has a separate input, also includes a calibrated input attenuator, and has a maximum sensitivity of 200 mv/cm over a pass band dc to more than 500 KC.

Two special features of *-hp-* 150A add much to the instrument's convenience and versatility. One is the automatic triggering circuit by which *one single preset adjustment establishes optimum triggering for almost all conditions and eliminates most adjustment during or even before measurement.* The other feature is the single shot sweep circuit. After firing, this circuit remains locked out until rearmed. A light indicates when the circuit is armed.

Etched Circuits

Every possible step has been taken to insure the mechanical and electrical convenience and reliability of *-hp-* 150A Oscilloscope. Controls are simplified, direct reading, concentric, color-coded and arranged logically by function. Tubes and circuits are grouped on hinged panels that swing out for simplified testing. Wherever possible, circuits are etched and unitized; and may be isolated from the instrument by unplugging. Etched circuits are mounted on translucent plastic for "look-through" convenience. A 15° turn removes the bezel, facilitating filter and CRT interchange. A door on the cabinet top gives direct access to CRT terminals, and a lever inside permits the CRT trace to be aligned with the graticule. The instrument includes a large, high volume cooling fan with replaceable air filter. All components are of highest quality obtainable. Model 150A is housed in a lightweight, streamlined metal cabinet equipped with leather carrying straps and a tilt bail for convenient viewing.

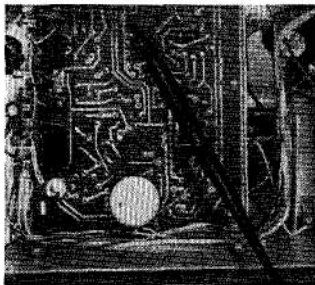

Unitized Circuits

Unitized construction is a new concept in oscilloscope design. Basic circuit elements are etched or assembled as separate units; circuits may be disconnected without soldering, merely by unplugging. Tubes are instantly accessible on swing-out panels.

New Low Capacity Probe

For use with Model 150A, *-hp-* has developed a new, pen-sized test probe with miniature alligator jaws. The probe has a 10 μmf capacitance, 10 megohm impedance and provides a 10:1 voltage division. Compensating capacity is adjustable by rotating one portion of the Nylon barrel.

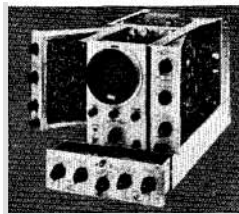

Specifications

-hp- 150A

Sweep

Range: 0.02 $\mu\text{sec/cm}$ to 15 sec/cm .
Calibrated: 24 calibrated sweeps in 1, 2, 5 and 10 sequence, 0.1 $\mu\text{sec/cm}$ to 5 sec/cm . Accuracy within 3%.
Vernier: Permits continuous adjustment of sweep time.
Triggering: Internally, line voltage; externally with 0.5 v or more.

Trigger Point: Any positive or negative level on positive or negative slope of signal triggering sweep. +30 v to -30 v range for external trigger.

Preset Triggering: Switch position on sweep mode control automatically selects optimum setting for stable triggering for majority of conditions.

Single Sweep: Sweep circuits may be set for triggered single sweep operation. After being triggered, sweep remains locked out until reset. Indicator light glows when sweep is armed.

Horizontal Amplifier

Sweep Magnification: Sweep may be expanded 5, 10, 50 or 100 times. Multiturn horizontal positioning control provides a fine degree of adjustment, permits viewing any 10 cm portion of expanded sweep.

Indicators: "Reminder" lights glow when sweep magnifier is used, or when expanded sweep time exceeds fastest calibrated sweep time.

External Input: Pass band dc to over 500 KC. Sensitivity range 200 mv/cm to 25 v/cm. Five calibrated ranges plus vernier.

Vertical Amplifier

Main Vertical Amplifier: Pass band dc to more than 10 MC. Optimum transient response and rise time less than 0.035 μsec .

Signal Delay: 0.25 μsec delay permits viewing leading edge of signal triggering sweep.

Input: Through plug-in preamplifier.

General

Amplitude Calibrator: 18 Calibrating voltages in 2, 5, 10 sequence, 0.2 mv to 100 v peak-to-peak, are available at a binding post to provide maximum flexibility. Accuracy within 3%. Approximately 1 KC square wave with rise and decay times less than 1 μsec .

Sawtooth Output: +20 to -20 v sawtooth waveform of sweep. Gate Output: +20 v signal for duration of sweep.

Illuminated Graticule: Edge-lighted graticule with controlled illumination, marked in centimeter squares with 2 mm subdivisions on major horizontal and vertical axes.

CRT Bezel: CRT bezel readily removable by a 15° twist, providing rapid means of changing filters and replacing CRT if different phosphors are required. Bezel locks to provide firm mount for standard oscilloscope camera equipment.

CRT Plates: Direct connection to deflecting plates via terminal in access compartment.

Intensity Modulation: Terminals provided; 20 v positive signal blanks CRT at normal intensity.

Cathode Ray Tube: 5AMP mono-accelerator flat face type with 5,000 v accelerating potential. Available with P1, P2, P7 or P11 screen.

Size: Width—13½"; Height—17¼"; Depth—25".

Weight: Approximately 65 lbs. net.

Power Supply: 115/230 v \pm 10%, 50/60 cycles. Approximately 500 watts.

Accessories Furnished: 2—AC-21A Probes. 1—Filter compatible with screen phosphor. 2—AC-76A BNC to binding post adaptors.

Price: \$1,000.00 f.o.b. Palo Alto, California. (Normally supplied with P2 screen. For P1 screen, specify 150A-1; for P7 screen, specify 150A-7; for P11 screen, specify 150A-11.)

-hp- 151A High-Gain Amplifier

Sensitivity Range: 5 mv/cm to 50 v/cm.

Input Attenuator: 12 calibrated ranges, in 0.5, 1, 2, and 5 sequence, from 5 mv/cm to 20 v/cm. Vernier permits continuous adjustment between ranges.

Input Impedance: 1 megohm shunted with 50 μmf .

Pass Band: dc to 10 MC, 0.035 μsec rise time.

Coupling: ac or dc.

Dual Inputs: Two signal inputs with Type BNC. Selection of either input by panel switch.

Price: \$100.00.

-hp- 152A Dual Channel Amplifier

Sensitivity Range: 0.05 v/cm to 50 v/cm.

Input Attenuator: 9 calibrated ranges, in 1, 2, 5 and 10 sequence, from 0.05 v/cm to 20 v/cm. Vernier permits continuous adjustment between ranges.

Input Impedance: 1 megohm shunted with 50 μmf .

Pass Band: dc to 10 MC, 0.035 μsec rise time.

Coupling: ac or dc.

Electronic Switching: By alternate sweeps or chopped at approximately 100 KC.

Vertical Positioning: Individually adjustable.

Polarity of Presentation: Input signal as applied or inverted.

Input Connectors: Type BNC both channels.

Price: \$200.00.

Data subject to change without notice. Prices f.o.b. factory.



200J/201C/202C AUDIO OSCILLATORS

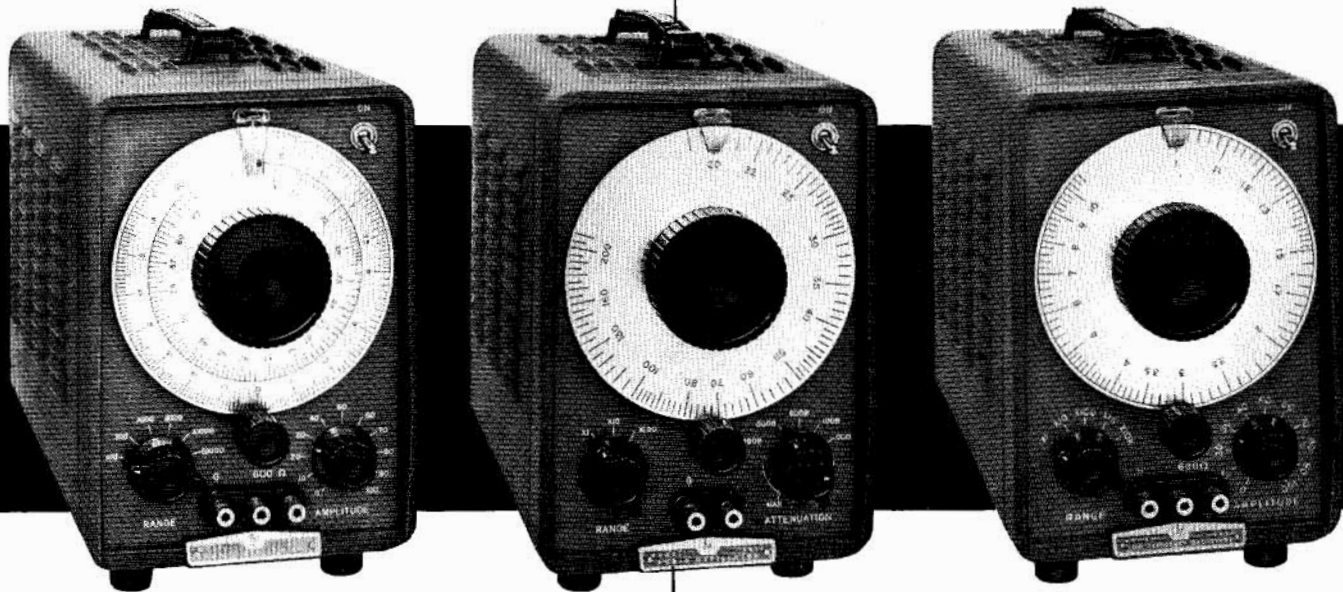

New! High Quality, Low Price

OFFERING utmost convenience and simplified operation along with high stability, wide frequency range, low distortion and built-in precision. Compact and easily portable in new rugged lightweight cabinet. The latest *-hp-* development in RC oscillator circuits combined with a mechanical layout designed for durability and accessibility. Reliability assured by *-hp-* practice of incorporating highest quality components available and rated to provide a large safety factor.

These fundamental features of all *-hp-* oscillators are also incorporated in these three new oscillators.

-hp- 200J, 6 cps to 6 KC, replaces *-hp- 200I* and is designed for

interpolation and similar work where frequencies must be known with extreme accuracy. Features are: new 160 mw balanced output, waveform purity and frequency unaffected by load, less than 0.5% distortion, and very high stability.

-hp- 201C, 20 cps to 20 KC, replaces *-hp- 201B* and offers a superior attenuator with new compact styling at a lower price. Meets requirements for speed, accuracy, ease of operation, waveform purity for high fidelity audio system or component testing, frequency comparison, and transmission line measurements. Delivers at least 3 watts to a 600 ohm load resistor.

-hp- 202C, 1 cps to 100 KC, replaces *-hp- 202B* and covers a wider and more convenient frequency spectrum. Waveform purity and frequency are virtually unaffected by load resistance. Excellent for subsonic, sonic, and supersonic applications in industrial production, field, or laboratory. Also features new 160 mw balanced output, high stability, low distortion, and a short recovery time when switching ranges.

Specifications

Model	Frequency Range	Calibration Accuracy	Output to 600 Ohms	Recommended Load	Maximum Distortion	Max. Hum & Noise †	Input Power	Weight—Lbs.		Size (Inches)			Price
								Net	Ship	W	H	D	
200AB	20 cps to 40 KC (4 bands)	±2%	1 watt (24.5 v)	600 ohms	1.0%	0.05%	65 watts	15	22	7½ x 11½ x 12¼		\$120.00	
200CD	5 cps to 600 KC (5 bands)	±2%	160 mw 10 volts	600 ohms*	0.5%	0.1%	110 watts	23	29	7½ x 11½ x 14¼		\$150.00	
200J	6 cps to 6 KC (6 bands)	±1%†	160 mw 10 volts	600 ohms*	0.5%	0.1%	110 watts	23	29	7½ x 11½ x 14¼		\$275.00	
200T	250 cps to 100 KC (5 bands)	±1%†	160 mw 10 volts	600 ohms*	0.5%	0.03%	170 watts	27	42	18¾ x 9 x 11¾		\$350.00	
201C	20 cps to 20 KC (3 bands)	±1%†	3 watts (42.5 v)	600 ohms**	0.5%‡	0.05%	75 watts	16	23	7½ x 11½ x 12½		\$225.00	
202C	1 cps to 100 KC (5 bands)	±2%	160 mw 10 volts	600 ohms*	0.5%§	0.1%	110 watts	27	34	7½ x 11½ x 14¼		\$300.00	

*Internal impedance is 600 ohms. Frequency and distortion unaffected by load resistance. Balanced output with amplitude control at 100. Use line matching transformer for other control settings. **Internal impedance approximately 600 ohms with output attenuator at 10 db or more. Approximately 75 ohms below 5000 cps with attenuator at zero. †Internal, non-operating controls permit precise calibration of each band. ‡0.5%, 50 cps to 20 KC at 1 watt output. 1.0% over full range at 3 watts output. §0.5%, 10 cps to 100 KC. 1.0%, 5 to 10 cps. 2.0% at 2 cps. 3.0% at 1 cps. ¶Measured with respect to full rated output. Frequency response is flat ± 1 db over instrument range. Reference level at 1 KC except *-hp- 200T* at 5 KC. Maximum overall size and weights are given for cabinet models. 19" rack models also available. Power Source: 115 or 230 volts ±10% at 50 to 1,000 cps.

Data subject to change without notice. Prices f.o.b. factory.

hp 400H VACUUM TUBE VOLTMETER

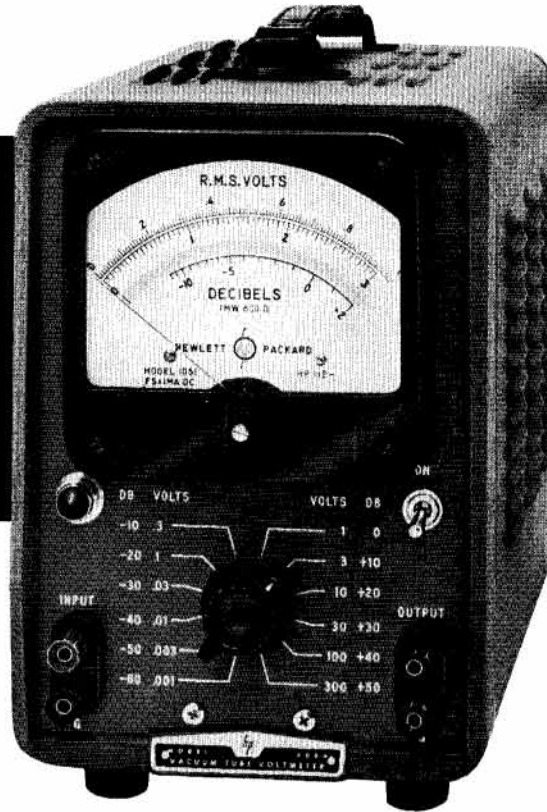

New! Extreme Accuracy of 1%; Covers 10 cps to 4 MC

NEW *hp*-400H has been adapted from the popular *hp*-400D voltmeter to make available an instrument combining general-purpose utility with extreme measuring accuracy.

Model 400H has a 5" indicating meter with mirror scale and measures voltages from 0.1 mv to 300 volts. The high input resistance of 10 megohms effectively minimizes loading to circuits under test. A stabilized amplifier-rectifier with feedback loop provides exceptional long term stability; even line voltage changes of $\pm 10\%$ cause negligible variations. Readings are direct in volts or db. Operation is extremely simple with overvoltage protection up to 600 volts on any range. The instrument is of highest quality construction throughout, and is available either in the lightweight, rugged *hp*-portable cabinet or for rack mounting.

Specifications

Voltage Range: 0.1 mv to 300 volts. 12 ranges, selected with front panel switch. Full scale readings of:

0.001	0.030	1.0	30
0.003	0.100	3.0	100
0.010	0.300	10.0	300 volts

Frequency Range: 10 cps to 4 MC

Accuracy: With nominal line voltages from 103 to 127 volts, overall accuracy is:

- within $\pm 1\%$ of full scale, 50 cps to 500 KC;
- within $\pm 2\%$, 20 cps to 1 MC;
- within $\pm 5\%$, 10 cps to 4 MC.

Long Term Stability: Reduction in G_m of amplifier tubes to 75% of nominal value results in less than 0.5% error from 20 cps to 1 MC.

Calibration: Reads rms value of sine wave. Voltage indication proportional to average value of applied wave. Linear voltage scales, 0 to 3 and 0 to 1.0; db scale, -12 db to +2 db, based on 0 dbm = 1 MW in 600 ohms, 12 ranges in 10 db steps.

Input Impedance: 10 megohms shunted by 15 $\mu\mu\text{f}$, 1 to 300 v; 25 $\mu\mu\text{f}$, 0.001 to 0.3 v.

Amplifier: Output approx. 0.15 v max. Internal impedance 50 ohms. Max. gain approx. 150 on 0.001 v range.

Power: 115/230 volts $\pm 10\%$, 50/1,000 cps, approx. 100 watts.

Dimensions: 11½" high, 7½" wide, 11¾" deep. 19" rack mount available.

Weight: Net 18 lbs. Shipping 25 lbs. (cabinet mount).

Price: \$325.00.

Data subject to change without notice. Prices f.o.b. factory.



TRAVELING-WAVE TUBE AMPLIFIERS



Specifications -hp- 492A

- Frequency Range:** 4 KMC to 8 KMC.
- Gain:** 30 db minimum.
- Output Power:** 10 milliwatts.
- Noise Figure:** Less than 25 db above theoretical.
- Pulse Rise, Decay:** 0.015 microseconds.
- Mod. Pulse Delay:** 0.020 microseconds.
- Mod. Voltage Amplitude:** 50 v positive pulse gives 40 db rf power change, sensitivity approx. 1 db/v.
- Helix Mod. Voltage:** Approx. 30 v peak-peak.
- Hum, Spurious Mod.:** 30 db below output signal.
- Adjustments:** Grid bias, helix voltage.
- Meter Monitors:** Cathode, Anode, Helix or Collector Current.
- Input Impedance:** 50 ohms. SWR less than 2.
- Output Impedance:** 50 ohms. SWR less than 3.
- Connectors:** Type N input and output, BNC modulation.
- Power:** 115 v \pm 10% , 50/60 cps, 110 watts.
- Dimensions:** Cabinet Mount: 7½" wide, 11½" high, 19½" deep.
- Weight:** Net 54 lbs. Shipping 93 lbs. (cabinet mount).
- Price:** \$1,500.00, including tube.
- Replacement Tube:** \$750.00 less \$125.00 credit for returned tube and capsule.

-hp- 494A

Same as above except:

- Frequency Range:** 7 KMC to 12.4 KMC.
- Gain:** 25 db minimum.
- Output Power:** 5 milliwatts.
- Mod. Pulse Delay:** Approx. 0.015 microseconds.

Data subject to change without notice. Prices f.o.b. factory

Broad Band Amplification, Versatile Modulation, 2 to 12.4 KMC

Now -hp- offers Traveling-Wave Tube Amplifiers for all frequencies between 2 and 12.4 KMC. -hp- 490B covers 2 to 4 KMC. This instrument supersedes -hp- 490A and has identical characteristics except for 30 db gain and provision for helix modulation. -hp- 491A covers the same range but with a higher output of 1 watt. (Details on both instruments are found in -hp- Catalog 22-A, pages 42, 43.)

New -hp- 492A and 494A are low level, high gain instruments with 30 and 25 db gain respectively. They offer the unique versatility of amplitude, pulse, phase or FM modulation, and are ideal for use as broad band amplifiers or isolating buffer stages.

All models use the exclusive -hp- coupling system with two separate helices for full energy transfer over a broad frequency range. All have front panel controls and metering for performance checks or continuous monitoring. All modulation connectors are brought out to the front panel.

Replacement traveling-wave tubes are available from the factory, encapsulated and ready for use.



REFLECTOMETER ACCESSORIES

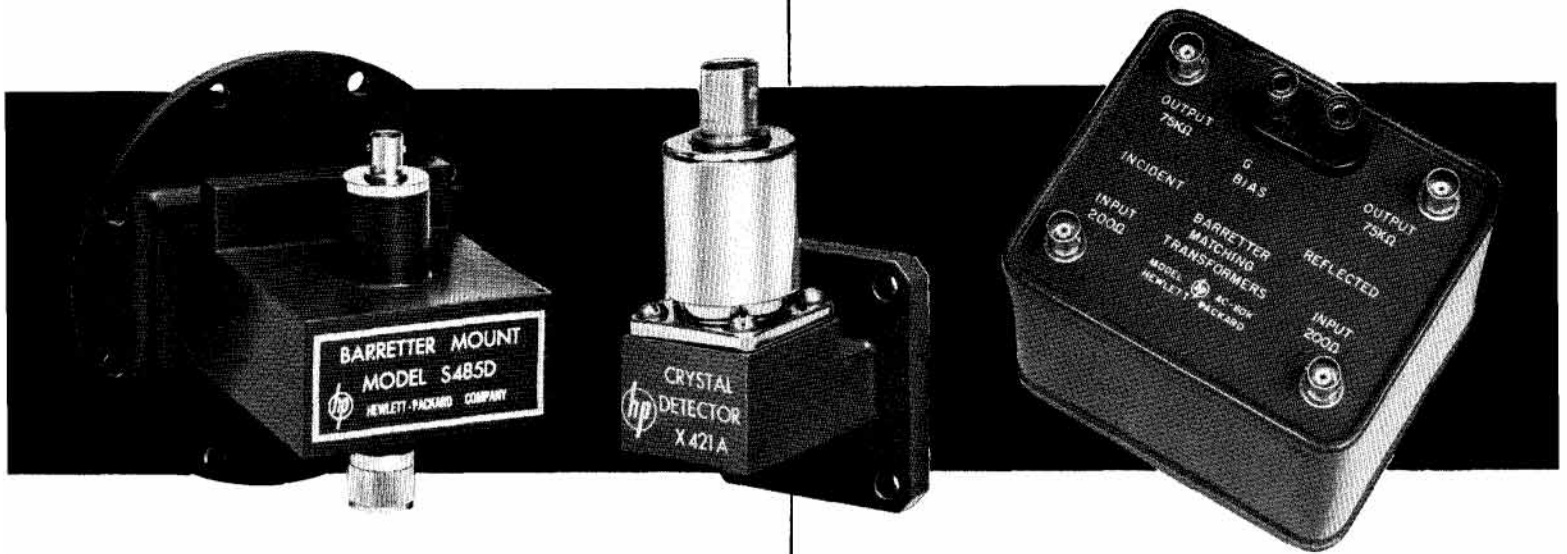

-hp- 485D Barretter Mounts

These instruments are accurate, square-law detectors for signal detection in reflectometer systems. -hp- mounts of this series are available for S, G, and J band waveguide systems. Mounts are supplied with factory installed barretters tested for SWR, frequency response, and square-law characteristics. Barretters employed are Sperry 821 or equivalent. (For other -hp- 485 series Detector Mounts, see -hp- Catalog 22-A, page 94.)

-hp- 421A Crystal Detector

At higher waveguide frequencies, crystals are provided as detector elements. -hp- X and P band detectors employ 1N26 silicon diodes. Supplied installed in a precision-made mount, the crystals have accurate square-law character-

istics over a 40 db range when operated into a selected value video load resistor which is internal and factory installed.

-hp- AC-60K Matching Transformer

This instrument consists of two step-up transformers and appropriate bias circuitry for impedance matching between -hp- 485 series Barretter Mounts and the new -hp- 416A Ratio Meter. Designed specifically for this reflectometer system application, -hp- AC-60K operates with 200 ohm barretters such as Sperry 821 or Narda N821B as detector elements. An 8.75 ma bias current is supplied from the Model 416A Ratio Meter. The Transformer measures 4 3/4" x 4" and is 3 1/2" high. Weight is 2 lbs. Price, including three cable assemblies, \$45.00.

Specifications

Model	Frequency Range KMC	Maximum SWR	Typical Sensitivity volt/milliwatt	Frequency Response	Deviation from Square-Law	Waveguide Size	Price
S485D	2.60 - 3.95	1.35	0.2	±1 db	±0.5 db	3" x 1 1/2"	\$145.00
G485D	3.95 - 5.85	1.5	0.2	±1 db	±0.5 db	2" x 1"	\$140.00
J485D	5.20 - 8.20	1.5*	0.2	±1 db	±0.5 db	1 1/2" x 3/4"	\$135.00
X421A†	8.20 - 12.4	1.5	0.1	±2 db†	±1 db†	1" x 1/2"	\$ 75.00
P421A†	12.4 - 18.0	1.5	0.1	±2 db†	±1 db†	.702" x .391"	\$ 85.00

*5.20 to 7.50 KMC. Increase to approx. 2.0 at 8.20 KMC.

†Detector Mounts are available as "matched pairs" with similar frequency response and square-law characteristics. In this case frequency response tolerance and square-law characteristic combined (excluding basic crystal sensitivity) is held to within ± 2 db for the matched pair.

All have BNC connector for detector output.

Data subject to change without notice. Prices f.o.b. factory.



523B ELECTRONIC COUNTER



Advantages:

- Direct frequency, period or time interval readings
- Highest quality, broad applicability, yet moderate cost
- Basic accuracy ± 1 count; stability 2 ppm per week
- Color-coded panel simplifies use by non-technical personnel
- Pulse output for Z-axis oscilloscope modulation

Use To Measure:

- Frequency:
 - Production quantities
 - Nuclear radiation
 - Power line frequencies
 - Rps and rpm
 - Very low frequencies
 - Oscillator stability
 - Repetition rates
 - Weight, pressure, temperature and acceleration—remote if desired

Time Interval, Period:

- Time between impulses
- Pulse length, shutter speeds
- Projectile velocity
- Relay operating times
- Precise event timing
- Interval stability
- Frequency ratios, phase delay

New! Measures Period, Time or Frequency 10 cps to 1.1 MC!

VERSATILE -hp- 523B is a completely new electronic counter designed to cover the widest possible range of measurement at no sacrifice of speed or convenience, and at lowest possible cost.

Basically similar to the well-known -hp- 522B, new 523B offers a greatly broadened frequency range of 10 cps to 1.1 MC. Time interval coverage is also broadened—3 μ sec to 100,000 seconds or 27.8 hours. Period measurement is available from 0.00001 cps to 10 KC.

Model 523B is conveniently contained in a small bench cabinet, and no extra-cost modification is needed to perform all functions. Results are displayed instantly and automatically in direct-reading form on six panels numbered 0 to 9.

Number illumination is bright for easy readability in any light; results are displayed in seconds, milliseconds, microseconds or kilocycles with automatic illuminated decimal point. Display time is variable from 0.1 second to 5 seconds or indefinitely.

Unskilled Personnel Can Operate

The new Counter is particularly designed for easy use by non-technical personnel. In addition to the direct reading and automatic decimal features, panel controls are color-coded for simple operation.

For frequency counting, *-hp-* 523B covers the range 10 cps to 1.1 MC. Measurements are accurate within ± 1 count plus crystal stability; stability is controlled to 2 ppm per week. Time base generator crystals are subjected to prolonged aging before installation in the Counter; and further to insure accuracy, a front panel connector permits application of a 100 KC primary standard; five gate times are available: 0.001, 0.01, 0.1, 1 and 10 seconds; the gate may also be operated manually.

For period measurement, the unknown controls the opening and closing of the gates, while the instrument's high dependability *-hp-* AC-4A Decade Counters record the number of cycles of an internal standard frequency. This internal decade divider circuitry provides a 10-period averaging measurement which reduces ten-fold the time effect of any triggering uncertainty. Period may be measured from 0.00001 cps to 10 KC in seconds, milliseconds or microseconds.

Time Interval Measurements

In time interval measurements *-hp-* 523B measures time from 3 microseconds to 100,000 seconds (27.8 hours), presenting results directly in seconds, milliseconds and microseconds. A special threshold feature permits measurements to be started and stopped only by signals of predetermined amplitude, polarity and slope. Separate start and stop channels are provided and each channel is separately adjustable for maximum flexibility. Two dual concentric panel controls permit time interval measurements to be started or stopped at any voltage level from -300 to $+300$ volts, on either positive or negative slopes. Terminals at the rear of *-hp-* 523B provide start and stop pulse voltages adjusted by these two controls. Model 523B employs etched circuits and high quality components throughout for maximum operating accuracy and dependability. Function lights are also provided to insure that circuits are operating properly.

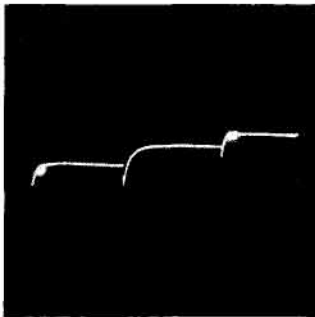

Figure 1. The exclusive start and stop output of *-hp-* 523B permits presentation on an oscilloscope of the portion of a waveform being measured by the Counter. Visual presentation can be particularly helpful when complicated waveforms are involved. Bright spots on the oscilloscope (provided from the 'scope's Z-axis modulation input) indicate the interval being measured.

Many phenomena common to industrial research and manufacturing can be measured quickly and conveniently with *-hp-* 523B and a simple transducer converting mechanical phenomena into electrical impulses. Such transducers include *-hp-* 506 Optical Tachometer Pickup for measuring rpm without mechanical contact to 300,000 rpm; and *-hp-* 508A/B Tachometer Generators for direct reading shaft speed measurements 15 to 40,000 rpm. Other transducers enable *-hp-* 523B to measure flow, pressure, projectile speed, etc.

Specifications

Frequency Measurement:

Range: 10 cps to 1.1 MC.
Accuracy: ± 1 count \pm stability (see General).
Input Requirements: 0.2 volt rms minimum.
Input Impedance: Approx. 1 megohm, 30 μ f shunt.
Gate Time: 0.001, 0.01, 0.1, 1, 10 seconds.
Reads In: KC; decimal point automatically positioned.

Period Measurement:

Range: 0.00001 cps to 10 KC.
Accuracy: $\pm 0.3\%$ (for measurements of one period), $\pm 0.03\%$ (10 period average) at 1 volt rms. Improved by greater input voltage.
Input Requirements: 1 volt rms minimum. Direct coupled.
Input Impedance: Approx. 1 megohm, 40 μ f shunt.
Gate Time: 1 or 10 cycles of unknown.
Standard Frequency Counted: 10 cps, 1 KC, 100 KC, 1 MC, or external applied frequency.
Reads In: Seconds, milliseconds, microseconds; decimal point automatically positioned.

Time Interval Measurement:

Range: 3 μ sec to 100,000 sec. (27.8 hours).
Accuracy: ± 1 /std. freq. counted \pm stability (see General).
Input Requirements: 1 v peak minimum. Dc coupled.
Input Impedance: Approx. 1 megohm, 25 μ f shunt.
Start and Stop: Independent or common channels.
Trigger Slope: Positive or negative on start and/or stop channels.
Trigger Amplitude: Continuously adjustable on both channels from -300 to $+300$ volts.
Std. Freq. Counted: 10 cps, 1 KC, 100 KC, 1 MC; External.
Reads In: Seconds, milliseconds, microseconds; decimal point automatically positioned.

General:

Registration: Six places on neon lamp decade units.
Stability: 2/1,000,000 per week. May be standardized against WWV.
Display Time: Variable approx. 0.1 to 5 seconds; display held indefinitely if desired.
Output Frequencies: Secondary standard frequencies available at front panel: 10 cps, 1 KC rectangular, 100 KC and 1 MC sine-wave (stability as above).
Trigger Output: Start and Stop pulse output (width approx. $\frac{1}{2}$ μ sec). Available for:
1. Voltage level selection of input signal for frequency measurements.
2. Z-axis modulation of oscilloscope for time interval measurements.
Self Check: Panel control provides automatic count of internal 100 KC and 1 MC frequencies to assure accuracy of gate and proper operation of counters.
External Standard: 100 KC from external primary standard can be applied to unit for highest accuracy.
Power: 115/230 volts $\pm 10\%$, 50/60 cps, approx. 285 watts.
Dimensions: Cabinet Mount: 13 $\frac{3}{4}$ " wide x 16 $\frac{1}{4}$ " high x 21" deep. Rack Mount: 19" wide x 14" high x 21" deep.
Weight: Net: 48 lbs. Shipping: 85 lbs. (cabinet mount).
Accessories Furnished: 2 AC-16D Cable Assemblies.
Price: \$1175.00.

Data subject to change without notice. Prices f.o.b. factory.

hp 540A TRANSFER OSCILLATOR



Advantages:

- Extends frequency counter accuracy to microwave region
- Permits measurement of pulsed, FM, CW, AM or noisy signals
- Provides multiple check for positive accuracy
- Measures FM deviation
- Includes self-contained oscilloscope detector
- Circuit elements usable separately
- Simple to use, compact, eliminates complex setups

Use It For:

- Fast, accurate determination of CW and AM signal frequencies
- Measuring center frequency or deviation range of FM signals
- Measuring frequency in presence of high noise levels
- High accuracy measurements of pulsed signals

Now! Measure Frequency to 12 KMC With Electronic Counter Accuracy

THE development of the new *hp*-540A Transfer Oscillator has made possible, for the first time, convenient frequency measurements far into the microwave region. These measurements can be made with accuracy heretofore available only at much lower frequencies.

Model 540A contains a highly stable, 100 to 220 MC—oscillator generating harmonics to 12 KMC for comparison with the unknown. The comparison device is a diode mixer, amplifier, and built-in oscilloscope (See Figure 1). Combined with *hp*-524B Electronic Counter, *hp*-525B Frequency Converter (524B's appropriate plug-in unit) and oscillosynchroscope or detectors as required, the 540A extends the 524B's range to 12 KMC with new convenience and accuracy.

In operation, with approximate signal frequency known, the *hp*-540A is tuned until one of its harmonics zero beats with the unknown. The multiplying factor is noted. The transfer oscillator frequency is then measured directly on the 524B counter. The 524B frequency reading, times the multiplying factor, gives the frequency of the unknown

signal. When the signal frequency is totally unknown, a convenient calculation employing two or more harmonics is used to determine the multiplying factor.

In measuring carrier frequency of pulsed signals, an external oscillosynchroscope is used to display the detected pulse. Zero beat appears as horizontal lines across the pulses when the oscillator is tuned to an exact sub-multiple. Video amplifier frequency response controls can be used to simplify this procedure.*

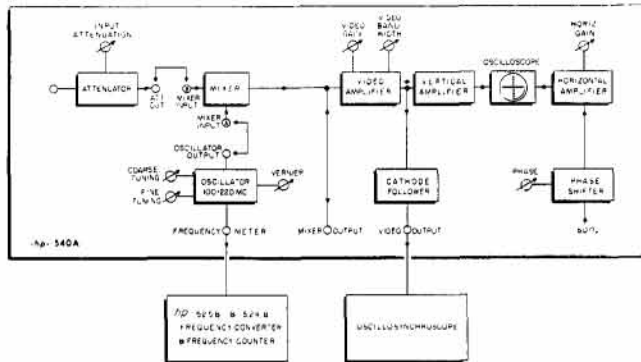

Figure 1. -hp- 540A with 524B, 525B and oscillosynchroscope.

In working with noisy or AM signals, the -hp- 540A response can be narrowed to obtain a more accurate indication of zero beat.*

In signals with appreciable FM, the 540A's oscilloscope presents a characteristic pattern pin-pointing upper and lower frequency deviation limits. If FM deviation is present, center frequency may also be determined.*

Accuracy

The system's accuracy is approximately 1 part per 1,000,000 or better on clean CW signals. On pulsed signals, accuracy is governed by carrier frequency and pulse length. On noisy or intense AM signals, the transfer oscillator system with -hp- 540A often provides the only means of accurate measurement. Overall system accuracy is better than 10 times that of the best microwave wavemeters.

Quality Features

Each of the circuit elements of -hp- 540A (Figure 1) may be used separately by shifting front panel patch cords. Controls are provided for coarse and fine mechanical tuning. There is also an electrical vernier with range approximately ± 125 ppm. The video amplifier has both gain and bandwidth controls. Horizontal input to the internal oscilloscope is power line frequency with phase control. Input attenuation is variable from approximately 20 to 80 db to adjust signal for optimum mixing level.

*For complete discussion of microwave measuring with transfer oscillator and electronic counter, write -hp- for Hewlett-Packard Journal, Vol. 6, No. 12.

Specifications

General

Frequency Range: 10 MC to 5,000 MC. (10 MC to 12,000 MC or higher with external detector such as -hp- 440A.)

Input Signal: CW, FM, AM or pulse.

Input Signal Level: Varies with frequency and individual crystals. Minimum input signal approx. 0 dbm to attenuator.

Accuracy: CW: Approx. 1/1,000,000 or better.

Oscillator

Fundamental Frequency Range: 100 MC to 220 MC.

Harmonic Frequency Range: Above 12,000 MC.

Stability: Less than 0.002% change per minute after 30-minute warmup.

Dial: Six inch dia., calibrated in 1 MC increments. Accuracy: $\pm 1/2\%$.

Output: Approx. 2 v into 50 ohms.

Attenuator

Range: Approximately 20 db to 80 db.

Input Impedance: 50 ohms, SWR: 1.5 max. at 1 KMC; 3 max. at 5 KMC.

Amplifier

Gain: Variable. Maximum 40 db or more.

Bandwidth: Variable. High Frequency: 3 db point adjustable approx. 1 KC to 2 MC. Low Frequency: 3 db point switched from 100 cycles to below 10 KC. Adjustable to above 400 KC.

Output: 1 volt rms maximum into 1,000 ohms.

Oscilloscope (Self-Contained)

Frequency Range: 100 cps to 200 KC.

Vertical Deflection Sensitivity: 5 mv rms per inch at mixer output.

Horizontal Sweep: Internal, power supply frequency with phase control, or external (connection at rear) with 1 v per inch. Sensitivity, 20 cps to 5 KC.

Miscellaneous

Connectors: Attenuator input, type N; all others type BNC.

Size: Cabinet Mount: 20 1/2" wide, 12 1/2" high, 15 1/4" deep.

Rack Mount: 19" wide, 10 1/2" high, 12 3/4" deep.

Power Supply: 115/230 v $\pm 10\%$, 50/1,000 cps, approximately 110 watts.

Auxiliary Equipment:

-hp- 524B Electronic Counter, \$2150.00.

-hp- 525B Frequency Converter, \$250.00.

-hp- 440A Detector Mount, \$85.00.

-hp- 150A High Frequency Oscilloscope, (see pages 4, 5).

Price: -hp- 540A Transfer Oscillator, \$615.00

Data subject to change without notice. Prices f.o.b. factory

hp 626A/628A SHF SIGNAL GENERATORS

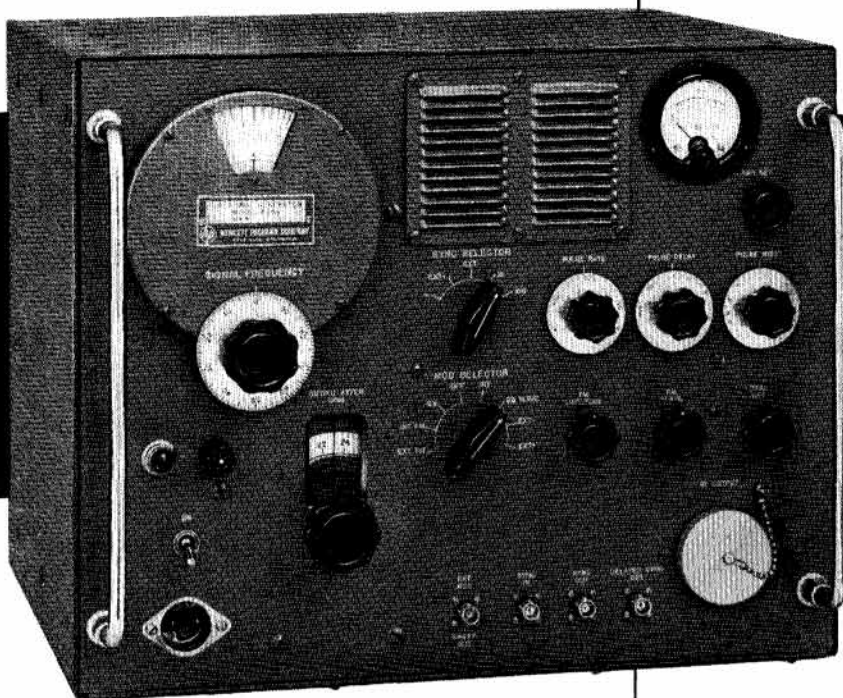

Advantages:

- Direct reading frequency control
- Direct reading output control
- 10 mw output over full range
- CW, FM or pulsed output
- Internal square wave modulation
- Broad pulsing capabilities
- Low internal SWR
- High stability, high accuracy
- Sturdy, compact, precision-built

Use To Measure:

- Receiver sensitivity
- Selectivity or rejection
- Signal-to-noise ratio
- Conversion gain, SWR
- Antenna gain
- Transmission line characteristics

Direct Reading, High Power— 10 to 21 KMC!

HERE are two new *-hp-* signal generators which extend the measuring versatility, convenience and accuracy of *-hp-* vhf signal generators to 21 KMC. The new *-hp-* 626A covers frequencies 10,000 to 15,500 MC, and the *-hp-* 628A covers frequencies 15,000 to 21,000 MC.

In design and operation, the new instruments are similar to *-hp-* generators for lower frequency ranges. Operation is very simple. Carrier frequency in MC is set and read directly on the large tuning dial. No voltage adjustment is necessary during tuning because the unique *-hp-* coupling device causes oscillator repeller voltage to track frequency changes automatically. Oscillator output is also set and read directly, and no frequency correction is necessary throughout operating range.

Versatile Modulation

Both *-hp-* 626A and 628A offer internal and external pulse modulation as well as internal square wave modulation and FM. Pulse repetition rate is continuously variable

from 40 to 4,000 pps, and pulse width is variable from 0.5 to 10 μ sec. Sync out signals are simultaneous with the rf pulse, or in advance of the rf pulse by any time span from 3 to 300 μ sec. The generators may be synchronized with an external sine wave and also with positive or negative pulse signals.

For internal FM, both instruments feature a sine wave sweep at power line frequency. Frequency deviation is variable up to ± 5 MC. For external FM, the generators have capacitive coupling to the klystron oscillator repeller.

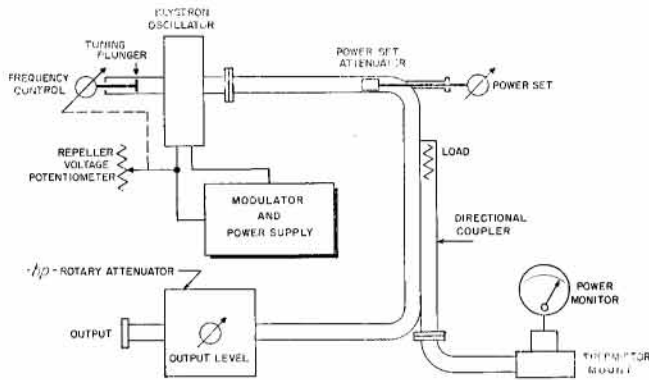

Figure 1. Basic circuit, -hp- 626A/628A.

Figure 1 shows the basic circuits of the new -hp- signal generators. The reflex klystron oscillator is tuned by a plunger driven by the direct-reading frequency dial and control. Repeller voltage is automatically tracked so that correct operating potentials are maintained over the entire frequency range. Klystron output is introduced into a power monitoring directional coupler through a rotary vane power set attenuator. The attenuator is adjusted to provide a fixed reading on the power monitoring meter.

The directional coupler provides very uniform coupling over the entire frequency range. The rotary attenuator which follows the coupler assures high accuracy and stability because the attenuation is governed by a precise mathematical law related to the angular rotation of the attenuator. The conductivity of the attenuating film does not affect the attenuation; thus the output of the generator is independent of humidity, temperature or the effects of long term aging. The attenuator also provides low SWR over the complete frequency range. On both -hp- 626A and 628A, the output connector is waveguide. Adapters furnished permit the instruments to be connected to WR-42, WR-62, or WR-90 waveguide. Thus the generators can be employed with all RETMA guides suitable for the 10 to 21 KMC range.

Specifications

Frequency Range: 626A, 10,000 to 15,500 MC; 628A, 15,000 to 21,000 MC.

Frequency Calibration: Dial direct reading in megacycles. Accuracy better than $\pm 1\%$.

Output Range: 10 mw to 1 μ w. (+ 10 dbm to - 90 dbm, 0 dbm = 1 mw.) Attenuator dial directly calibrated in output dbm. SWR less than 2.5 at + 10 dbm; 1.2 at 0 dbm and lower.

Output Monitor Accuracy: Better than ± 1 db.

Output Attenuator Accuracy: Better than $\pm 2\%$ of attenuation in db introduced by output attenuator.

Output Connector: 626A, 0.850" by 0.475" waveguide, WR-75, Flat Cover Flange. 628A, 0.590" by 0.335" waveguide, WR-51, Flat Cover Flange.

Leakage: Less than minimum calibrated signal generator output.

Modulation: Internal or external pulsed, FM, or square wave.

Internal Pulse Modulation: Repetition rate variable from 40 to 4,000 pps. Pulse width variable 0.5 to 10 μ sec.

Internal Square Wave Modulation: Variable 40 to 4,000 cps controlled by "pulse rate" control.

Internal Frequency Modulation: Power line frequency, deviation up to ± 5 MC.

External Pulse Modulation: Pulse Requirements: Amplitude 15 to 70 volts peak positive or negative; width 0.5 to 2,500 μ sec.

External Frequency Modulation: Provided by capacitive coupling to repeller of klystron. Maximum deviation approximately ± 5 MC.

Sync Out Signals: 20 to 50 volts peak into 1,000 ohm load. Better than 1 μ sec rise time.

- (1) Simultaneous with rf pulse—positive.
- (2) In advance of rf pulse—positive, variable 3 to 300 μ sec.

External Synchronization: (1) Sine wave, 40 to 4,000 cps, amplitude 5 to 50 volts rms.

- (2) Pulse signals 0 to 4,000 pps, 5 to 50 volts amplitude, positive or negative. Pulse width 0.5 to 5 μ sec. Rise time 0.1 to 1 μ sec.

Power: 115/230 volts $\pm 10\%$, 50/60 cps, approx. 200 watts.

Size: Cabinet Mount: 17" wide, 13 $\frac{3}{4}$ " high, 14 $\frac{3}{4}$ " deep.

Weight: Net 65 lbs.; Shipping 100 lbs.

Accessories Furnished: -hp- 626A (a) M to X Band waveguide adapter, WR-75 to WR-90 guide. (b) M to P Band waveguide adapter, WR-75 to WR-62 guide.

-hp- 628A (a) N to P Band waveguide adapter, WR-51 to WR-62 guide. (b) N to K Band waveguide adapter, WR-51 to WR-42 guide.

-hp- 626A and -hp- 628A Power Cord.

Accessories Available: -hp- AC-16K Video Cable Assembly. -hp- 626A. M362A Low Pass Filter. -hp- 628A. N362A Low Pass Filter.

Price: -hp- 626A, \$3,250.00. -hp- 628A, \$3,000.00.

Data subject to change without notice. Prices f.o.b. factory.

hp 670 SHF SWEPT FREQUENCY OSCILLATORS



Advantages:

- Coverage of all frequencies 2.6 to 10 KMC
- 10 mw output full range
- Automatic adjustable motor-driven frequency sweep
- Full modulation capabilities
- Direct-reading frequency dial

Use Them For:

- Reflectometer measurements
- Waveguide test voltages
- Slotted line measurements
- Microwave system frequency response
- Antenna checks

Four Automatic-Sweep Microwave Oscillators Cover 2.6 to 10 KMC

THESE unique new instruments are compact, efficient, versatile sources of test voltages for measurements in the S, G, J and H microwave bands. They provide at least 10 milliwatts of power throughout their ranges. Waveguide-beyond-cutoff attenuators provide a convenient method of varying the output level.

Automatic Frequency Sweep

Frequency control is operated by a directly calibrated dial. An unusual feature is the automatic, adjustable motor drive provided for this dial. Two adjustable stops determine upper and lower limits of the automatic sweep. The sweep may be set to cover a 10% to 20% segment, or any larger portion of the instrument's frequency range. The sweep system operates at a constant velocity selected to provide an easily seen trace on a medium-persistence cathode ray tube. A linear sweep voltage proportional to the sweep

is available for horizontal oscilloscope deflection. Use of this sweep voltage enables the dc oscilloscope to present a frequency panorama with horizontal sweep distance approximately proportional to frequency.

-hp- 670 oscillators are supplied with or without mechanical sweep. The automatic sweep feature is easily added later.

Varied Modulation Capabilities

-hp- 670 series oscillators include provision for grid and reflector modulation. In conjunction with -hp- 717A Klystron Power Supply (see page 82 of -hp- Catalog 22-A) the following modulations are available—*Reflector Modulation*: FM, 60 cycle sine wave; Square Wave, repetition frequency continuously variable 400 to 1,000 cps. *Grid Modulation*: Square Wave, repetition frequency continuously variable 400 to 1,000 cps. For greater versatility, external modulation voltages can also be applied.

During automatic sweeping, grid modulation only is used because reflector voltage must track frequency changes. In manual use, either grid or reflector modulation may be used. AM or FM reflector modulation is available provided reflector voltage is adjusted for optimum output at each operating frequency. (This adjustment is provided on -hp- 717A Klystron Power Supply.)

Wide Applicability

-hp- 670 oscillators are versatile sources of both fixed and swept frequencies for all types of microwave measurements where high level test signals are required. The instruments are particularly useful in slotted line measurements and checks of transmission system characteristics. They are also ideal sources of fixed or swept frequencies for reflection coefficient measurements. Motor-driven models are particularly useful with -hp- 416A Ratio Meter (see page 98, 99 of -hp- Catalog 22-A) in forming high speed, accurate systems for measurement of reflection coefficients. Suggested arrangement of equipment for such measurements is given on pages 96 and 99 -hp- Catalog 22-A, on Technical Data sheet for -hp- 416A Ratio Meter, and in Volume 6, No. 1-2 of the Hewlett-Packard Journal. (Any of above sent on request.)

Operation

The operating principle of the -hp- 670 series oscillators is illustrated in Figure 1. The sweep motor produces three simultaneous actions: (1) through a rack and pinion gear assembly, shorting plungers are moved in and out within the resonant cavity; (2) reflector voltage is tracked to insure accurate frequency control; (3) sweep voltage is generated as a horizontal oscilloscope input.

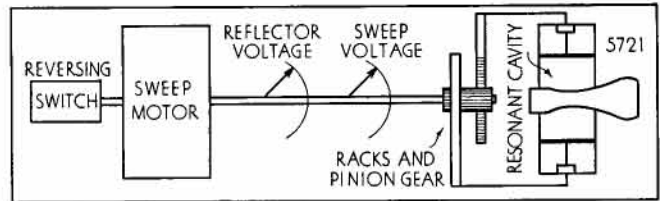

Figure 1. Operating diagram of -hp- 670 series Swept Frequency Oscillator with sweep motor drive.

Specifications

Frequency Range: -hp- 670S—2.6 to 4.0 KMC; -hp- 670G—4.0 to 6.0 KMC; -hp- 670J—5.85 to 8.2 KMC; -hp- 670H—7.0 to 10.0 KMC.

Output Power: At least 10 mw full range.

Attenuator Range: 100 db (not calibrated).

Modulation: (a) Grid modulation for optimum swept-frequency performance. (b) Reflector modulation for optimum single-frequency performance. Modulating signals must be provided from external source (normally -hp- 717A Klystron Power Supply which may be externally modulated).

Mechanical Sweep: Adjustable to cover any 10% to 20% or larger segment of instrument's frequency range. Sweep rate approx. 30 to 50 cycles per minute depending on swept frequency range.

Sweep Voltage Provided: Linear voltage proportional to mechanical sweep. (Approx. 100 v change equivalent to maximum swept frequency range.)

Connectors: Type N rf output, BNC sweep voltage. Special power cables mating with -hp- 717A provided.

Power: 115 v $\pm 10\%$, 50/60 cps, 25 watts. Requires external power supply for Klystron. (-hp- 717A Power Supply recommended.) Requires: 1,000 v, 20 ma; 0-600 v, 5 ma; 6.3 v ac, 0.6 ma.

Klystron: Type 5721 supplied with instrument.

Dimensions: Cabinet mount: 7½" wide, 11½" high, 20" deep.

Weight: Net 18 lbs. Shipping 54 lbs.

Accessories Furnished: 1 Power Supply Special Mating Connector, 1 Power Cord.

Accessories Available: -hp- AC-16D Video Cable Assembly, \$2.65; -hp- AC-16Q rf Cable Assembly, \$12.00; -hp- 717A Klystron Power Supply, \$375.00; -hp- AC-97A Sweep Motor Assembly, \$75.00; -hp- AC-97B Sweep Motor Assembly (¼ Normal Speed), \$100.00.

Price: -hp- 670SM, 670GM, 670JM, 670HM, \$1,175.00 (Includes AC-97A sweep motor assembly installed.) -hp- 670S, 670G, 670J, 670H, manually operated, \$1100.00.

Data subject to change without notice. Prices f.o.b. factory.

hp 764D-767D DUAL DIRECTIONAL COUPLERS



Permit Reflectometer Measurements In Coaxial Systems

RELECTOMETER systems save much engineering time in the development and manufacture of broad band apparatus; now the new *hp* dual directional couplers make reflectometer measurements practical in VHF-UHF coaxial systems.

The new couplers have a very flat frequency response and high directivity so that reflectometer accuracy is ade-

quate for system checks and alignment. Their high power handling capacity and low insertion loss means they may be installed permanently in coaxial lines for power monitoring. They are dual devices; hence a power meter or detector may be connected to either "incident" or "reflected" secondary terminals to simplify maximizing forward power. Collectively, the four couplers cover all frequencies from 216 to 4,000 MC.

The instruments are compact, with a sturdy aluminum frame for unique ruggedness. Highly stable heat resistant materials are used to insure long term operating accuracy.

Specifications

Model	Coupling (db)	Frequency Range KMC	Primary SWR (max.)	Secondary SWR (max.)	Directivity (minimum)	Coupling Accuracy	Price
764D	20 db	216 - 450 MC	1.10	1.10	30 db	±1 db	\$125.00
765D	20 db	450 - 940 MC	1.15	1.20	30 db	±1 db	\$125.00
766D	20 db	940 - 1975 MC	1.20	1.30	26 db	±1 db	\$125.00
767D	20 db	1900 - 4000 MC	1.25	1.50	26 db	±1 db	\$125.00

Power handling capacity, all couplers 50 watts CW, 10 kw peak. Type N connectors throughout. All couplers include *hp*-803A-76G Shorting Plug for reflectometer calibration.

Data subject to change without notice. Prices f.o.b. factory.

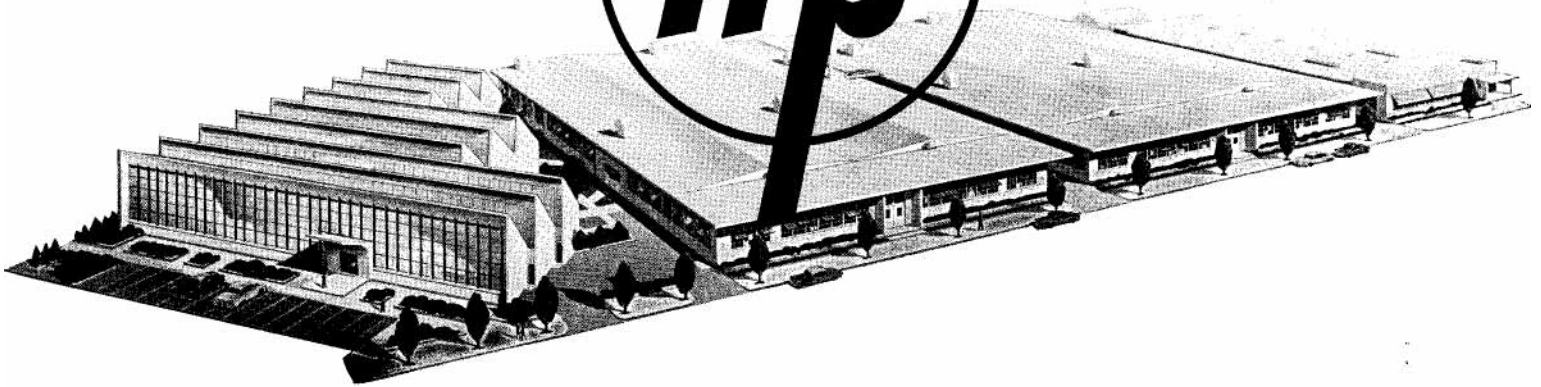

complete coverage

In electronic test instruments, Hewlett-Packard gives you complete coverage several different ways.

In development — *-hp-* engineer teams are continually at work designing and producing accurate, helpful new instruments that meet and anticipate the demands of electronics.

In instrumentation — the *-hp-* line is the world's largest and most complete. You choose from over 250 instruments the ones that provide exactly the measuring coverage you require.

In frequency coverage — *-hp-* makes nearly every kind of useful electronic test instrument. And, for almost all

useful frequencies, too. For example, *-hp-* signal generators offer solid frequency coverage from 10 to 21,000 MC; *-hp-* voltmeters from 2 to 700,000,000 cps, oscillators from .008 to 10,000,000 cps.

In personal service — *-hp-* has selected the best independent organizations to give you personal help with measuring problems. Electronics specialists—men trained by Hewlett-Packard—save you time by helping select the exact *-hp-* instrumentation you need—and following through to be sure the equipment is properly utilized to serve you best. These men are located in major business centers—as near as your telephone. Call them when you need personal help,—in your plant, today.

Albuquerque, New Mexico
Neely Enterprises
107 Washington St. S. E.
Albuquerque 5-5586

Asbury Park, New Jersey
I. E. Robinson Company
702 Mattison Avenue
DUnkirk 9-2404

Atlanta 5, Georgia
Bivins & Caldwell
3133 Maple Drive, N. E.
CHerokee 7522

Bogota, New Jersey
R. M. C. Associates
114 East Main Street
Diamond 2-5343

Bridgeport 8, Connecticut
Yewell Associates, Inc.
1101 East Main Street
FOrest 6-3456

Camp Hill, Pennsylvania
I. E. Robinson Company
2120 Market Street
REgent 7-5541

Chicago 40, Illinois
Alfred Crossley Associates, Inc.
4501 North Ravenswood Ave.
UPtown 8-1141

Cleveland 21, Ohio
S. Sterling Company
4311 Mayfield Road
EVergreen 2-4114

Dallas 9, Texas
Earl Lipscomb Associates
P. O. Box 7084
ELmhurst 5345

Dayton 9, Ohio
Alfred Crossley Associates, Inc.
53 Park Avenue
OXmoor 3594

Denver 3, Colorado
Hytronic Measurements Associates
446 Broadway
SHerman 4-2241

Detroit 35, Michigan
S. Sterling Company
15310 West McNichols Rd.
BRoadway 3-2900

Fort Myers, Florida
Arthur Lynch & Associates
P. O. Box 466
Edison 4-4431

High Point, North Carolina
Bivins & Caldwell
Security Bank Building
High Point 3672

Houston 5, Texas
Earl Lipscomb Associates
P. O. Box 6573
JACKson 4-9303

Kansas City 30, Missouri
Harris-Hanson Company
7916 Paseo Blvd.
HILLand 6744

Las Cruces, New Mexico
Neely Enterprises
126 S. Water Street
JACKson 6-2486

Los Angeles, California
Neely Enterprises
3939 Lankershim Blvd.
North Hollywood, Calif.
STAnley 7-0721

New York 21, New York
R. M. C. Associates
170 East 80th Street
TRafalgar 9-2023

Phoenix, Arizona
Neely Enterprises
641 East Missouri
CRestwood 4-5431

Sacramento 14, California
Neely Enterprises
1317 - 15th Street
GILBERT 2-8901

San Diego 6, California
Neely Enterprises
1029 Rosecrans Street
ACademy 3-8106

San Francisco 18, California
Neely Enterprises
2830 Geary Blvd.
WALnut 1-2361

Seattle 99, Washington
Ron Merritt Company
120 West Thomas Street
GARfield 6644

St. Louis 17, Missouri
Harris-Hanson Company
2814 South Brentwood Boulevard
MISSION 7-4350

St. Paul 14, Minnesota
Alfred Crossley Associates, Inc.
2388 University Avenue
MIDway 5-4955

Syracuse 2, New York
J. D. Ryerson Associates, Inc.
412 East Genesee St.
SYRacuse 76-8344

Toronto 10, Ontario, Canada
Atlas Radio Corporation, Ltd.
50 Wingold Avenue
RUSsell 1-6174

Upper Darby, Pennsylvania
I. E. Robinson Company
7404 West Chester Pike
SHERwood 8-1294

Waltham 54, Massachusetts
Yewell Associates, Inc.
751 Main Street
TWInbrook 3-7420

Washington 9, D. C.
Horman Associates, Inc.
2017 S Street, N. W.
DEcatur 2-5705



Registered Trademark of the Hewlett-Packard Company

New, low cost, versatile

INDUSTRIAL COUNTER

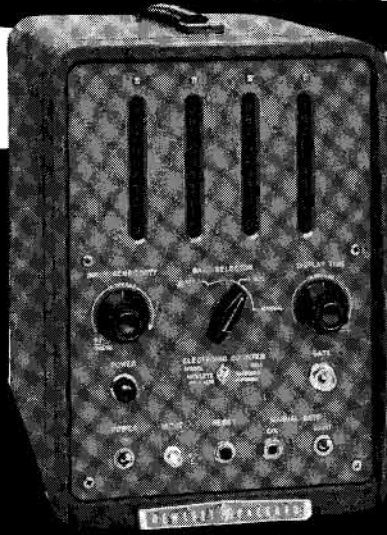

Measures frequency, speed, rpm, rps, random events
Measures weight, pressure, temperature, acceleration*
Direct numerical readings 1 cps to 120 KC
High accuracy, simple operation, compact, rugged

-hp- 521A—\$475.00

New -hp- 521A is designed to be the most useful, accurate low cost industrial counter ever offered. It measures frequency, speed, rpm, rps, and counts random events within a selected time interval. With transducers, it measures weight, pressure, temperature, acceleration and other phenomena which can be converted to frequency. It is direct reading in cps, rpm or rps, and can be used readily by non-technical personnel. Period of count is 0.1 or 1 second; display time can be varied.

The 50/60 cycle power circuit is used as the time base; or, for greater accuracy, a plug-in crystal controlled time base is available at extra cost. There are accessory power supplies of -150 v dc, +300 v dc and 6.3 v ac. Connections are also supplied for photocells and an external 60 cycle standard. Lightweight, compact, sturdy; particularly useful with -hp- Optical Tachometer Pickups and Tachometer Generators. -hp- 521A, \$475.00 (with plug-in crystal time base, \$575.00).

Other versatile -hp- Counters

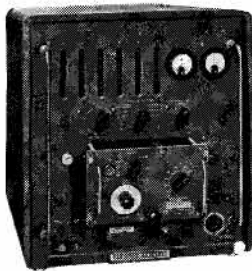

-hp- 524B Electronic Counter with 525/526 series Plug-ins. Revolutionary all-purpose, direct-reading counter. Buy basic counter, plug-ins giving measuring coverage you need now. Later add other inexpensive plug-ins to double, triple counter's usefulness. Basic counter range: Frequency 10 cps to 10 MC, period 0 cps to 10 KC, stability 1/1,000,000. -hp- 524B, \$2,150.00 Δ .

-hp- 525A/B Frequency Converters extend 524B's range to 100 or 220 MC, increase video sensitivity. -hp- 525A/B, \$250.00.

-hp- 526A Video Amplifier increases counter's sensitivity to 10 mv, 10 cps to 10 MC. \$150.00.

-hp- 526B Time Interval Unit permits counter to measure interval 1 μ sec to 100 days with accuracy of 0.1 μ sec, $\pm 0.001\%$. \$175.00.

-hp- 522B Electronic Counter. Compact, moderate price; frequency, period or time measurements. 10 cps to 100 KC. Reads direct in cps, KC, seconds, milliseconds. Automatic count reset, repetitive action. Stability 5/1,000,000, display length variable. Easily used by non-technical personnel. \$915.00 Δ .

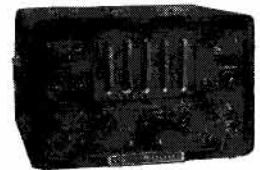

-hp- 508A Tachometer Generators. Use with electronic counters, frequency meters to measure directly 15 to 40,000 rpm. Produces 60 cycle output frequency per revolution; (-hp- 508B produces 100 cycles) -hp- 508A or 508B, \$100.00.

-hp- 506A Optical Tachometer Pickup. For measuring rotation 300 to 300,000 rpm. Ideal for moving parts of small energy or where mechanical connection is impractical. \$100.00.



Data subject to change without notice. Prices f.o.b. factory. Δ Rack mount slightly less. *With transducers.



HEWLETT-PACKARD COMPANY

275 PAGE MILL ROAD, PALO ALTO, CALIFORNIA, U. S. A.

Cable "HEWPACK" DAVENPORT 5-4451

Sales Representatives in All Principal Areas