

# HEWLETT-PACKARD JOURNAL



JULY 1968

# A Practical Time-Shared Computer System

*Using Conversational BASIC, a new 16-terminal system doesn't try to do everything for everyone, but still satisfies nearly all the user's needs.*

**By Thomas C. Poulter, Jr.**

WITH THE GROWTH OF COMPUTERS IN SPEED, POWER AND PRICE, 'time-sharing' has received increasing acceptance as a means of making the power of a large and expensive computer available on-line, to individual users, efficiently and economically. Generally, time-sharing systems have been characterized by their large size, multilingual capability, complex executive programs, and high cost. Experience with these systems has shown that most users pay a high price for features they seldom use. Given a choice, most time-sharing users prefer a simple, conversational language, such as the Dartmouth College developed BASIC. Yet the implementation of BASIC represents a relatively small fraction of the cost of most time-sharing systems.

Thus the desire to try to do everything for everyone has resulted in a generation of time-sharing systems far

*Cover: A mobile teleprinter terminal with a telephone acoustic coupler brings a computer into the lab area. Up to 16 users may use the computer simultaneously in the HP Model 2000A Time-Shared System.*

*In this Issue: A Practical Time-Shared Computer System; page 2. IEC Renames Noise Contour; page 7. A Rubidium Vapor Frequency Standard; page 8. Comparing Frequency Standards; page 15.*

more powerful than most users require, and so expensive that very few users could justify owning their own system. In the past, most time-sharing systems have been owned by major users, such as universities or large corporations, or by commercial time-sharing services, where a large number of users, each buying time by the hour, support the expense of a large computer system.

## System Design Objectives

The development project for the Hewlett-Packard Model 2000A Time-Shared BASIC System was initiated with the objective of developing a system to fulfill economically the majority of a user's needs, while leaving the more complex and expensive functions to be satisfied by larger systems. BASIC was selected as the system language because of its widespread application and acceptance as a time-sharing language.

Certain of the system's bounds were dictated by the system hardware considerations. Together with efficiency considerations, the teletype multiplexer design and the computer's 16-bit word length combined to fix the maximum number of simultaneous users at 16. The maximum program length was selected to equal the storage capacity of one disc track, or 5440 computer words.

Hewlett-Packard's own experiences with time-sharing computer use contributed greatly to both the decision to develop the system and the design of the system itself. Our terminals are used in circuit analysis and design computations, market projections, in-process production calculations, and cost analysis, to name a few. About 90% of the in-house use of time-sharing has been in BASIC. A number of other computer facilities are available and are regularly used for the larger and more complex programs.

## System Hardware

The time-sharing system is built around the HP Model 2116B Computer with a 16-bit word length (plus parity) and 16,384 words of magnetic core memory. For time-sharing operation the computer is equipped with the following:

### Internal

- Direct memory access
- Extended arithmetic unit
- Power fail interrupt
- Memory parity check
- Time base generator
- Teletype multiplexer

### External

- Magnetic disc memory
- High speed tape reader
- Power supply extender
- Heavy duty teleprinter

*Heart of the HP Model 2000A Time-Shared System is the HP Model 2116B Computer. Space is provided for expanding the disc memory. With the control teleprinter, left, the operator is able to communicate with the system and to log information.*

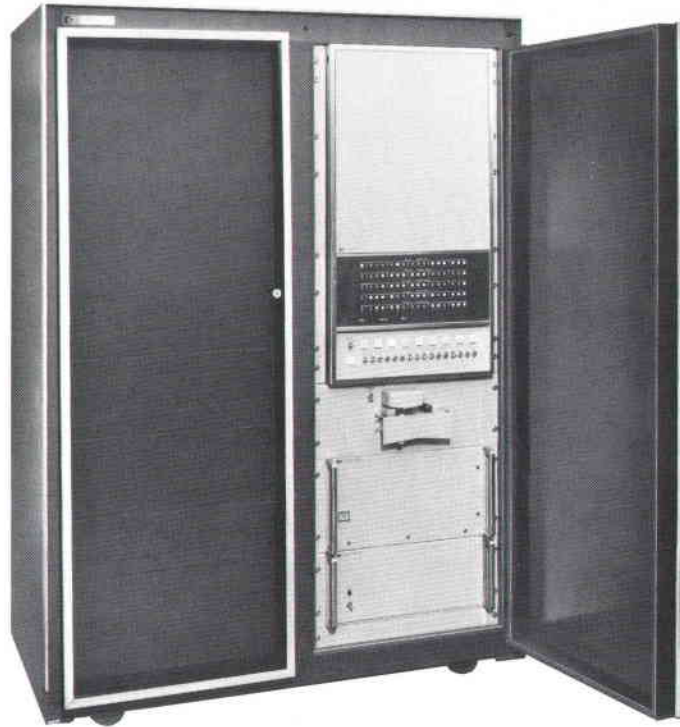

The first four internal options provide the high speed data transfer and computation, and the internal checking of power levels and parity errors necessary for best efficiency and reliability. The time base generator provides a time base for determining time of day, for measuring system usage, and for timing the sharing of program execution time.

A special teleprinter multiplexer was developed for the system. Occupying a single input/output channel, it services simultaneously all sixteen user channels, one with each bit of the 16-bit word. For maximum reading accuracy, the multiplexer samples each incoming bit eight times. Since the teleprinter's bit rate is 110 per second, a multiplexer sampling rate of 880 per second is required.

For bulk high speed memory, the system uses a magnetic disc memory with 348,160 words of storage. The disc is used by the system for storage of current programs (87,000 words), storage of a file copy of the system executive program (16,000 words), for storage of system tables required for the library and accounting system (11,000 words), and for storage of saved user programs (235,000 words). Disc storage can be expanded by adding up to three more disc units providing over 1.25 million

words of program storage. The 16 millisecond average disc access time, coupled with the executive's optimum timing techniques assure the efficiency required for handling the maximum 16 users at once.

To provide for rapid loading of the system executive or other software systems, the time-sharing system is equipped with an optical paper-tape reader. Operating at 300 characters per second, the tape reader can be used to load the entire system in less than two minutes. Once

### **What Is Time Sharing?**

Time sharing is broadly defined as the use of a central processor for several purposes within the same time interval. This may include many things, such as airline reservation, process monitoring and control. But to most engineers, time sharing means quick access to a computer for solving day-to-day problems. Multiplexing techniques enable two or more users to share the computer from terminals which may be nearby or hundreds of miles away. The number of terminals and the complexity of the problems that may be handled are largely determined by the size and capability of the computer, and the level of sophistication of the software system.

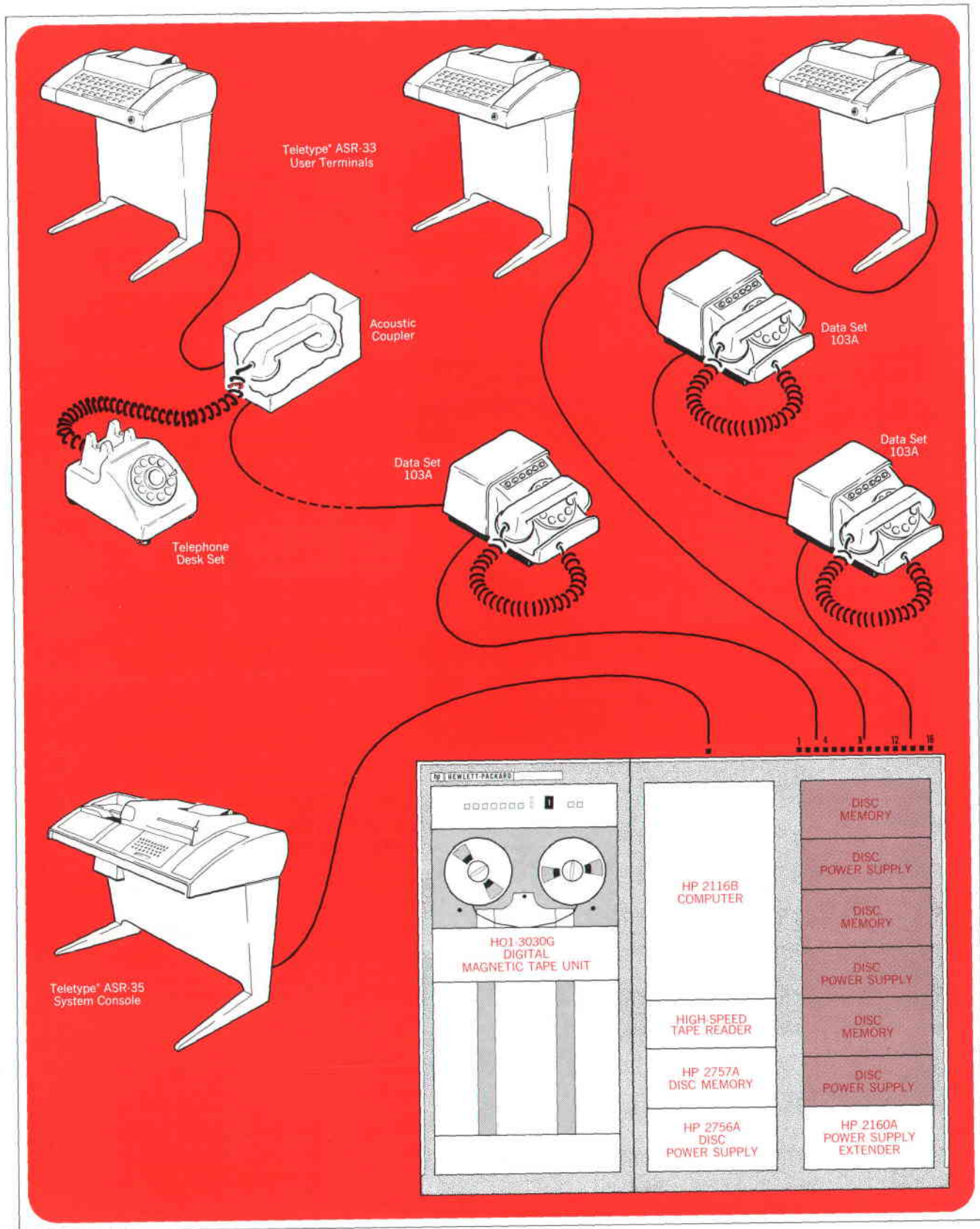

Up to 16 terminals can be operated simultaneously with the Model 2000A system. Terminals may be tied into the system in one of the three ways shown. The magnetic tape unit is an option, as are the shaded items in the right cabinet.

loaded into core memory the time-sharing software can be stored and reloaded from the disc memory in milliseconds, or from the optional magnetic tape unit in a few seconds. With the power supply extender, the system has adequate power for the full range of disc and tape options.

The heavy duty teleprinter serves as the system control console and is connected to the computer through a separate I/O interface. It is used for operator communication with the system and for logging system information. Using this system control teleprinter, the operator can also control access to the system by assignment of user account numbers and passwords.

### User Terminals

The teleprinters used as terminals with the system are the Teletype Models 33-ASR or 35-ASR. Communication with the system at rates up to 10 characters per second is possible either through the keyboard and printer, or through the paper tape reader and punch. For local service, up to one mile, the terminals can be wired directly to the system. For longer distances or for greater operating flexibility, the terminals can be connected to the system through regular voice-grade telephone lines using coupling equipment such as the Bell System Data Set 103A. Use of the telephone system allows a greater number of terminals to be served by the system; up to sixteen users can be handled simultaneously on a first call-first served basis.

### System Software

The system software can be divided into five major sub-systems:

- Executive program
- Multiplexer control program
- BASIC language compiler
- Accounting system
- Library system

The time-sharing executive program directs the computer's support of the following functions:

- Teletype input and output multiplexing
- Real time clock
- System console commands
- User terminal commands
- Program execution
- Accounting records

Each user on the system is assigned one of the 16 disc tracks used for storage of current programs. Of the 5440 word maximum program length, approximately 400

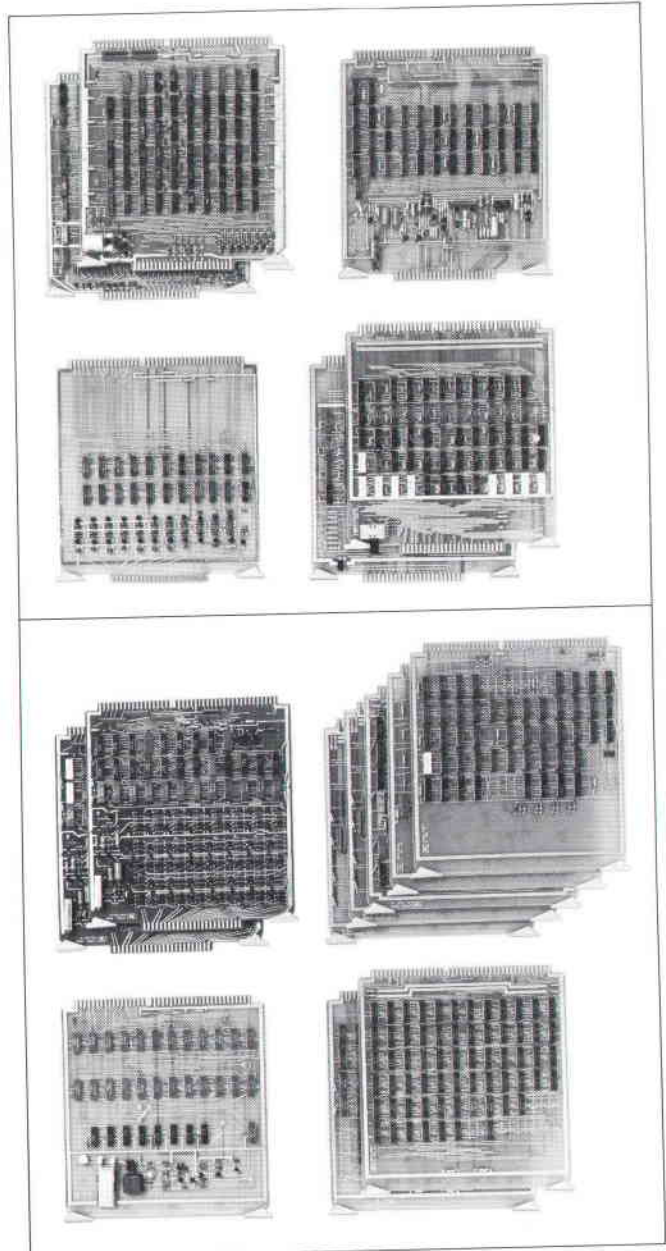

*Interface circuitry is on the group of cards, top. At the upper left is the magnetic tape interface; upper right is the teletype interface for system control; at the lower left is the paper tape reader interface, and the disc interface is shown at the lower right. In the bottom group, the teletype multiplexer and automatic telephone disconnect cards are shown at the upper left, the five cards which make up the direct memory access at the upper right, the time base generator at the lower left, and the two extended arithmetic unit cards at the lower right.*

## HP 2000A BASIC Language

BASIC is a simple, yet powerful programming language designed for on-line conversational computation. A computer program written in BASIC consists of numbered statements. The computer executes these statements in sequence unless an instruction within a statement directs otherwise. Each statement specifies an action to be taken by the computer, not as the statement is typed, but when the program is executed.

The program example below, named 'PRIMES,' illustrates the entry and execution of a BASIC language program. The program prints the prime numbers from 2 to 200 by testing all odd integers for factors. While this program is neither elegant as a technique nor an efficient use of computer time, it does demonstrate the ease with which programs can be written and executed on the system.

```

NAME PRIMES
10 PRINT 2
20 FOR N=3 TO 200 STEP 2
30   FOR I=3 TO SQR(N)
40     IF N/I = INT(N/I) THEN 70
50   NEXT I
60 PRINT N
70 NEXT N
80 END

RUN
2      3      5      7      11     13     17     19     23     29     31     37
41     43     47     53     59     61     67     71     73     79     83     89
97     101    103    107    109    113    127    131    137    139    149    151
157    163    167    173    179    181    191    193    197    199
  
```

### HP Model 2000A Time-Shared System

The HP Model 2000A is a time-shared computer system capable of simultaneously serving up to sixteen on-line user terminals. It operates in BASIC language with conversational program entry, editing, execution, listing, and storage operations. A system control teleprinter provides control over system start-up and shut-down, the public and private libraries, and the accounting system. User terminals are served through a teletype multiplexer and may be wired directly to the system if located within one mile, or connected via a telephone system with suitable couplers. The standard system includes all hardware and software necessary for normal operation. System options include additional disc memory, data set cables for connecting to telephone data sets, nine-channel magnetic tape recorder for off-line storage of the software system and libraries, and a telephone auto-disconnect board for automatic disconnecting of invalid callers.

**PRICE:** HP Model 2000A Time-Shared BASIC System,  
Rack mt., (with cabinet) 115 V, 60 Hz **\$89,500**

#### CONSISTS OF:

2116B-M2, M5, M8, M9, M11 Computer  
(K2) 2754A-M3 Teleprinter with 12531B  
(K3) 2737A Punched Tape Reader with 12532A  
(K10) Time Base Generator, 12539A  
(K34) 2757A-M1 Disc Memory with 2756A and 12561A

(K36) 2160 Power Supply

12584A-M1 Teletype Multiplexer

2992B-M11 Dual Bay Cabinet (with doors)

#### MODIFICATIONS:

T3 2757A-M1 Disc Memory with 2756A and 12561A **\$20,000**

T4 12584-8006 Data Set Cable **50**

T5 HO1-3030G Magnetic Tape Unit with 12559A **18,500**

T6 12584A-M2 Telephone Auto-disconnect **1,500**

**MANUFACTURING DIVISION:** PALO ALTO DIVISION  
395 Page Mill Road  
Palo Alto, California 94306

words are reserved for system use. The storage required by a program statement depends upon the statement length, but on the average, statements require about ten words of storage. Two words of storage are required for each variable or array element. Thus about 5000 words are available for statement storage (or 500 statements) less any storage required for program variables.

User's programs are brought into core from the disc for one of several reasons:

- Addition, deletion, or replacement of a program statement
- Transfer of a program to or from the library
- Reading of a program statement for listing or punching
- Resequencing a program
- Running (executing) the program

When in execution, the user's program may be returned to current disc storage for one of several reasons:

- Completion of execution
- Filling of the output buffer
- Input requested from the terminal
- Higher priority service required by another user; program editing or listing
- End of one-second execute time quantum, if other users are waiting for execution.

Programs in core for other than execution are returned to current disc storage at the completion of the service.

Response to program statement editing is typically less than 0.3 second. The wait for execute time varies from less than 1 second, for a lightly loaded system, to an average of 4 seconds, for a fully loaded system (i.e., 16 users). Interactive programs (requiring frequent data input from the user) will have a shorter wait time, typically 1 second or less, than programs with extensive execution.

The multiplexer control program operates in response to the interrupts from the multiplexer and performs the following functions:

- For each interrupt (880 per second), input a 16-bit word representing the input status of the 16 user channels, and sort the bits according to user channel.
- Determine for each channel, by analysis of successive samples, whether the input is a mark or a space, packing the respective bits into 8-bit bytes, representing characters.
- Construct a 16-bit output word, with one bit per user channel, with the following content:

1. For each user receiving output from the system, transmit from his output buffer the character string, bit by bit, character by character.
2. For each user sending to the system, echo bit by bit, each character received.

- Output the word to the teletype multiplexer for transmission to the users.

Since there is no synchronism between teleprinters, the driver must be able to handle each channel as an independent entity.

The BASIC language compiler operates interpretively. Program statements are stored in a special 'condensed' form and are converted to machine language in sequence as required for execution. The condensed program form is sufficiently similar to the original source program that a source program listing can be reconstructed from the stored program.

The compiler supports a user's program inputs in three phases. The first phase is active while the user is entering program statements. It checks each statement for format and syntax and, if correct, condenses the statement and forwards it for inclusion in the user's program. If the statement form is incorrect the statement is discarded and a diagnostic message is sent to the user describing the nature of the error. The second phase is active when the user requests that his program be 'RUN'. Some of the functions performed by the second phase include allocation of space for arrays as defined in 'DIM' (dimension) statements, and checking the logical structure of the program for correct statement ordering and loop formation.

Any errors found during Phase II are listed and control returned to the user. If the program is correct the operation is transferred to the third phase where the actual execution is performed.

The third phase begins with the lowest numbered statement and executes each statement in turn unless instructed otherwise. The executing program may request and accept input from the user and/or output information on the user terminal.

The accounting system provides for validating each user as he enters the system by means of an account number and a password. If the number-password combination matches a valid combination then the user is logged onto the system and can work with his programs. While the user is connected, the accounting system keeps track of the accumulated terminal time. When the user signs off, the system outputs the accumulated time for

## IEC Renames Noise Contour

We have just been informed by the chairman of the International Electrotechnical Commission that they have decided to recommend that the 'N' weighting contour for sound-level meters be called 'D' from now on. This makes it consistent with the A, B, and C weighting contours already in use.

The D (formerly N) contour was developed mainly for monitoring jet aircraft noise. (See 'Loudness Evaluation,' Hewlett-Packard Journal, November 1967.)

that session and the total for that accounting period along with the number of words of disc storage saved by that user.

The library system permits saving of programs on the disc in two categories. PUBLIC programs are entered into the system by the system operator using a special account number-password. Such programs are available to all system users, but can only be modified by the system operator. PRIVATE programs are those saved by each user under his own account number and are available only to him.

### Acknowledgments

The time-sharing system project team consisted of: *Software System* — Mike Green (manager), Gerould Smith and Lewis Leith. *Hardware System Design* — Stephen Porter. *Hardware System Engineering* — Al Marston and Willis Shanks. *Industrial Design* — Gerry Priestley. *Product Marketing* — Tom Poulter and Paul Schmidt. ■



**Thomas C. Poulter, Jr.**

Tom Poulter is a graduate of Stanford University, 1957, with a BS degree in physics. After graduation he spent seven years in the development and engineering of instrumentation for ordnance and rocket testing.

He joined the HP Dymec Division, now the Palo Alto Division, in 1964 where he was project manager for a line of signal conditioning instruments. Tom is presently Systems Product Manager for the division.

# A Rubidium-Vapor Frequency Standard for Systems Requiring Superior Frequency Stability

By Darwin H. Throne

THE AVAILABILITY OF STABLE AND PRECISE FREQUENCY SOURCES has been one factor that has led in recent years to progress in such fields as deep-space communications, satellite ranging, doppler radar and others. Basically, the frequency problem to be dealt with in many of these applications is to have high short-term stability often along with long-term stability. The combination of these two requirements in one frequency source is not so readily achieved. It may not be generally realized, for example, that a frequency source with less than superior long-term

stability may still have superior short-term stability, and vice versa. "Short term" as used here refers to the interval needed to make a measurement, typically from a fraction of a second to several seconds.

A type of frequency source that does have a high order of short-term and long-term frequency stability is the rubidium-vapor or rubidium gas-cell standard. Fig. 1 shows a recently-designed standard of this type which embodies advances that make it particularly suited for work of the sort mentioned above. The new atomic standard has the short-term stability for which rubidium-type standards are recognized. In addition it has a high and specified long-term stability together with simple adjustability of output frequency. This group of characteristics makes the standard valuable for use where even the best quartz standards are inadequate or where better short-term stability than that of other standards is required.

The simplified method of adjusting the standard's output frequency consists of a set of quasi-calibrated controls which, if desired, can be used to change the standard from an atomic-time scale to the UTC scale ( $300 \times 10^{-10}$  parts below the atomic scale).

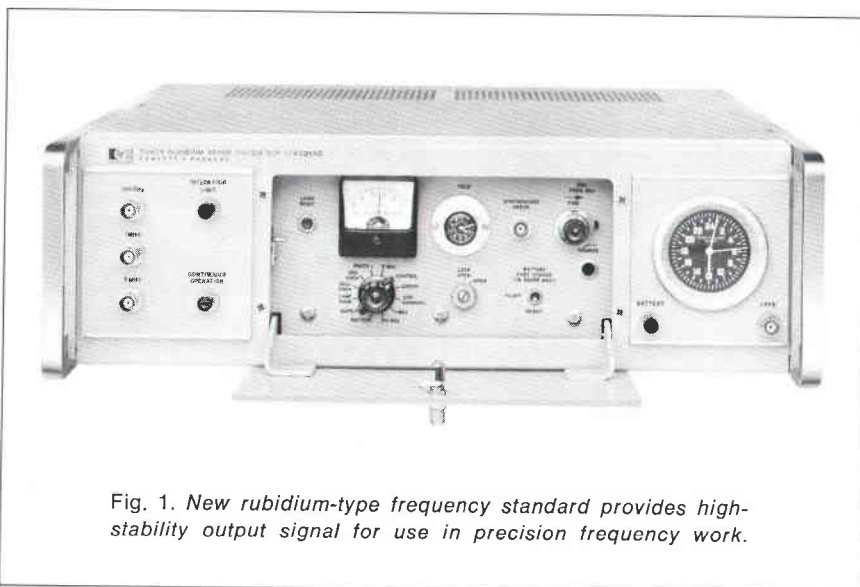

Fig. 1. New rubidium-type frequency standard provides high-stability output signal for use in precision frequency work.

The new standard further has a small size and modest weight that enable it to be easily transported — by airplane, if desired. A relatively fast warm-up time of less than two hours complements the transportability. Still higher portability is achieved in a second version of the instrument having battery standby.

### Stability

Much of today's work involving precision frequencies is concerned with a high degree of short-term frequency stability. The signal being transmitted by a satellite or space probe, for example, must often be stable to parts in  $10^{11}$  for the system to extract the desired information from the signal. This sort of stability is achieved only by a few of the highest-quality types of frequency sources, of which the rubidium standard offers some special advantages. The most important of these is that it achieves very good short-term and long-term stability at a price level considerably below that of contending types. The new standard achieves, for example, a rated short-term stability of less than 1 part in  $10^{11}$  rms frequency change for 1-second averaging and a long-term stability of less than 2 parts in  $10^{11}$  frequency change per month. This level of performance makes the rubidium standard a solution for many frequency-stability problems.

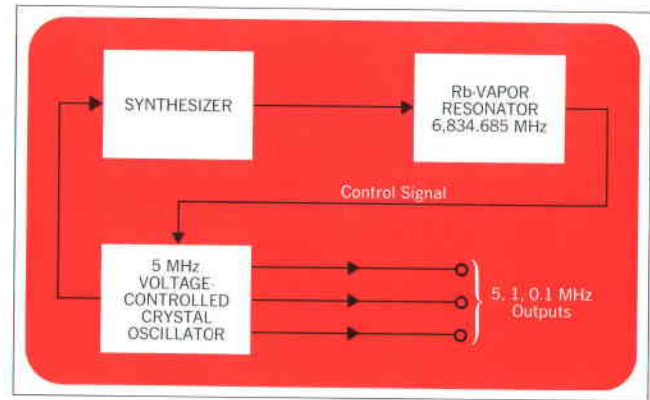

Fig. 2. Fundamental operating arrangement of new rubidium-vapor frequency standard.

The high stability of the standard results from the use of an atomic resonator operating with a flywheel in the form of a very-high-quality quartz-crystal controlled oscillator (Fig. 2). The closed-loop bandwidth of the control system is limited — about 2 Hz — so that the stability of frequency output for intervals (averaging times) of a fraction of a second is essentially that of the crystal oscillator. The short-term stability of this oscillator is very high — equal to that of HP's most stable crystal

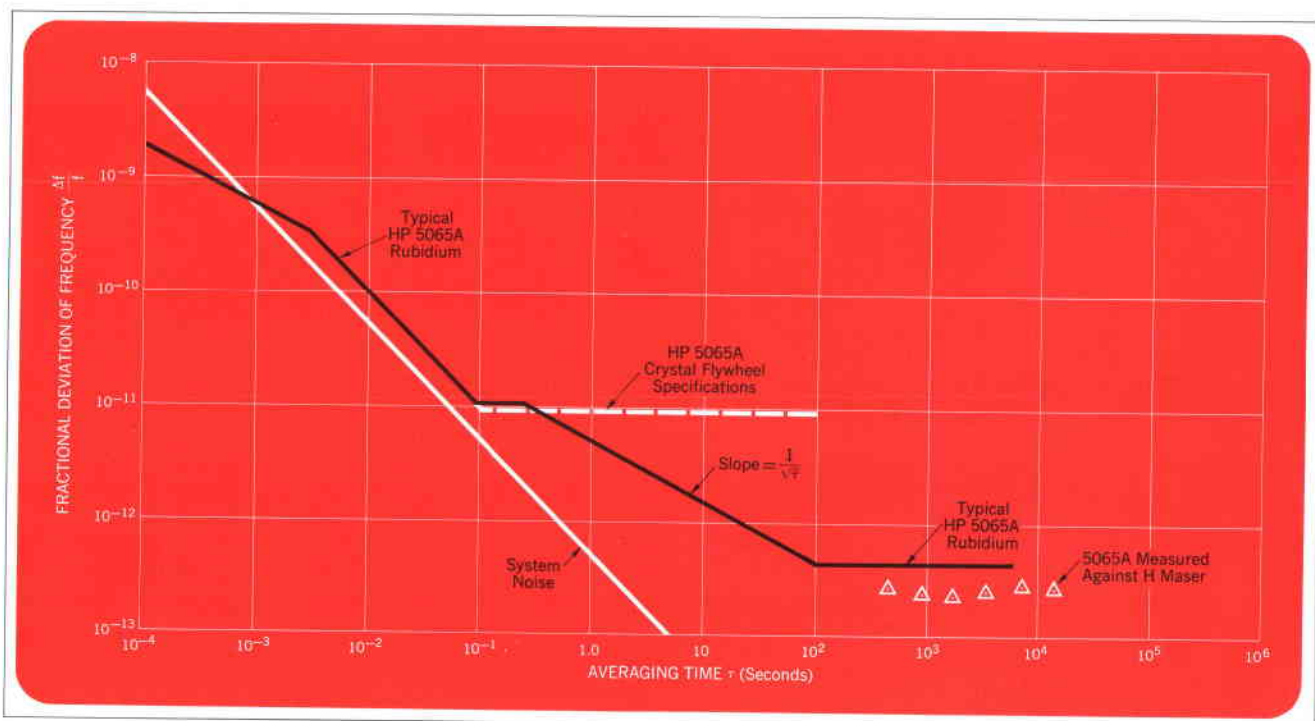

Fig. 3. Typical stability curve (solid line) of HP Model 5065A Rubidium Standard for wide range of averaging times. Long averaging times (lower right) were measured against a hydrogen maser; data obtained from record shown partly in Fig. 8.

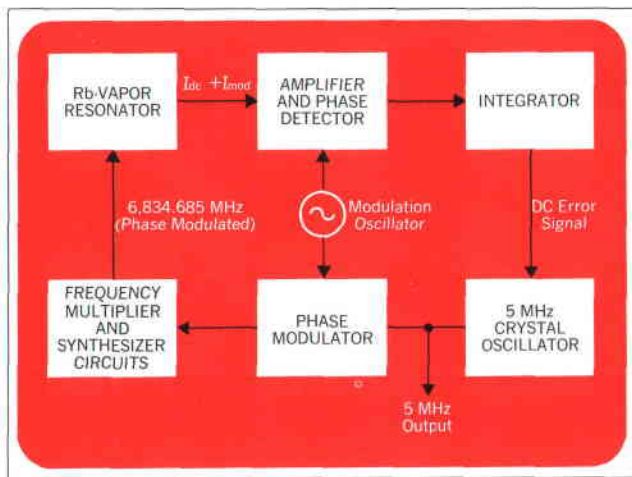

Fig. 4. Basic circuit arrangement of rubidium frequency standard.

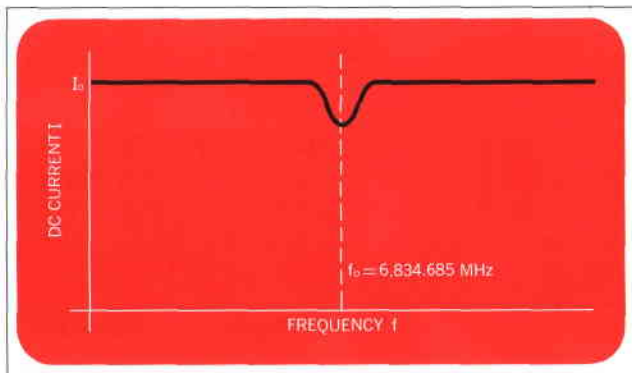

Fig. 5. Output current characteristic from rubidium-cell optical detector as a function of drive frequency.

standard. As longer averaging times are considered, the control system constrains the crystal oscillator to the superior long-term stability of the atomic resonator. The result is the combination of superior long- and short-term frequency stability. The bandwidth of the control loop is fixed at a value that yields the full short-term stability of the crystal oscillator without degradation by atomic resonator noise. Other bandwidths would provide little improvement in either short- or long-term stability.

### Stability vs Averaging Time

The measured stability typical of the new standards is shown in the heavy curve of Fig. 3. This stability was measured by comparing two of the new standards against one another in a system that had a noise level indicated

by the dashed line. The systematic noise level is of consequence because the instability being measured is extracted by the measuring system as noise and measured in those terms.\*

In examining the stability curve shown in Fig. 3 it is evident that for short averaging times the new standard's stability does in fact follow that of the crystal flywheel for averaging times up to approximately the time constant of the control loop (100 milliseconds). The short-term instability is, indeed, so near to that of the measuring system that the performance of the standard may be better than that shown.

As the averaging time becomes longer than that of the loop time constant, the measured frequency stability improves as  $1/\sqrt{\tau}$ ,  $\tau$  being the averaging time. This trend continues to about 100 seconds where the stability curve tends to become more constant. For averaging times longer than 2 to 3 hours, the stability continues at about the same level under room temperature conditions. Under harsher environments, temperature effects and other environmental factors begin to influence stability.

### Basis of Operation

Fig. 4 shows the general arrangement of the electronics of the new standard. The rubidium gas cell is excited by the frequency-multiplied output of the 5-MHz crystal oscillator, which in turn is voltage-controlled by a dc signal derived from the output of the gas cell. The gas cell or resonator has an absorption characteristic similar to that shown in Fig. 5. The dip in the cell's output current at its resonant frequency is utilized by phase-modulating the frequency (6,835.685 MHz) that drives the cell. An error current at the modulating frequency derived from the cell is amplified, phase-detected, and applied as a control voltage to the crystal oscillator from which the RF signal was obtained.

### Optical Pumping and the Rubidium Resonator

The rubidium resonator is shown schematically in Fig. 6. In operation, the RF oscillator produces in the spectral lamp a plasma in which the rubidium atoms are

\* The curve shown in Fig. 3 is in general agreement with the detailed analysis made by L. S. Cutler and C. L. Searle<sup>1</sup> of frequency fluctuations in frequency standards due to noise. This analysis indicates that for averaging times large in comparison with the closed loop bandwidth the fractional frequency deviation varies as  $1/\sqrt{\tau}$ , assuming that the atomic resonator noise is white noise. For averaging times longer than 100 seconds, it appears that flicker noise begins to determine the frequency stability. The measurements shown in Fig. 3 were made as indicated by Cutler and Searle (ibid) and were analyzed on an  $N = 2$  basis as outlined by Allan<sup>2</sup>. The method calculates the rms values of the successive differences in frequency of two oscillators.

1. L. S. Cutler and C. L. Searle, 'Some Aspects of the Theory and Measurement of Frequency Fluctuations in Frequency Standards,' Proceedings of the IEEE, Vol. 54, No. 2, pp. 136-154, February, 1966.  
2. David W. Allan, 'Statistics of Atomic Frequency Standards,' Proceedings of the IEEE, Vol. 54, No. 2, pp. 221-230, February, 1966.

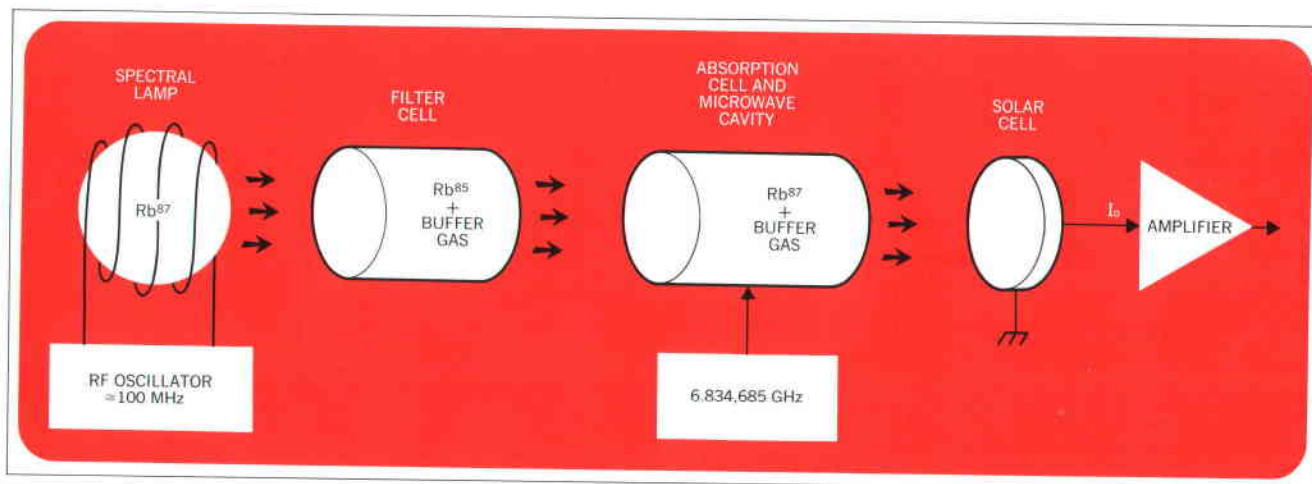

Fig. 6. Schematic representation of rubidium-vapor cell arrangement.

energized to an excited state. As the atoms then relax, they emit light at two closely-spaced wavelengths. The filter cell is located in the light beam from the lamp and absorbs one of these spectral radiations. The remaining radiation falls on the absorption cell where it is absorbed by the  $\text{Rb}^{87}$  atoms of the lower ( $F = 1$ ) ground state (Fig. 7) which are then pumped into the optical state. These atoms shortly decay because of collision with other gas molecules and fall into either of the two ground states. Since atoms have been taken only from the lower ground state, and only part of the decaying atoms return to this state, this state becomes depopulated. The cell then becomes transparent to the radiation from the lamp/filter combination. This radiation is sensed by the solar cell that follows the absorption cell. By now applying a magnetic field to the cell at a frequency corresponding to the transition from the upper to the lower ground state (6,834.685 MHz), atoms in the upper ground state are caused to decay to the lower ground state. The atoms that fall into the lower ground state then absorb some of the incident optical radiation, causing the cell to become more opaque at this frequency and producing the dip in the curve of Fig. 5. A small dc magnetic field parallel to the RF field is used to separate the Zeeman states of the hyperfine levels and causes the transition to occur between the  $\Delta M_F = 0$  states.

To immerse it in the RF magnetic field, the cell is located within a suitable microwave cavity. The cell is partially filled with a buffer gas in addition to the rubidium gas to lengthen the lifetime of the Rb atoms in the cell and thus increase interaction time. The presence of the buffer gas somewhat offsets the natural frequency of the cell, so, although the performance of the system is

very high, the cell cannot truly be called a primary standard of frequency. The cell and the lamp are temperature-controlled to minimize frequency changes.

#### Phase Plot

A curve of considerable interest for precision frequency work is shown in Fig. 8. This curve is a magnified continuous plot of the phase difference between an output frequency from a representative sample of the new standard and a very stable reference signal of the same frequency obtained from a hydrogen maser. Such masers are considered to be the most stable frequency generators in existence. Phase change appears as the fine structure in the recorded line. The general slope of the plot is not of interest since it merely indicates that the two signals were not precisely identical in frequency.

The resolution of the record is high. It can be determined from the reference line drawn on it with a slope

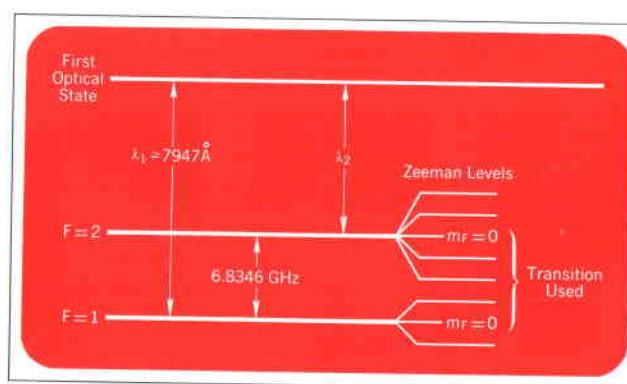

Fig. 7. Simplified diagram of the energy levels of  $\text{Rb}^{87}$  which are of significance in operation of cell.

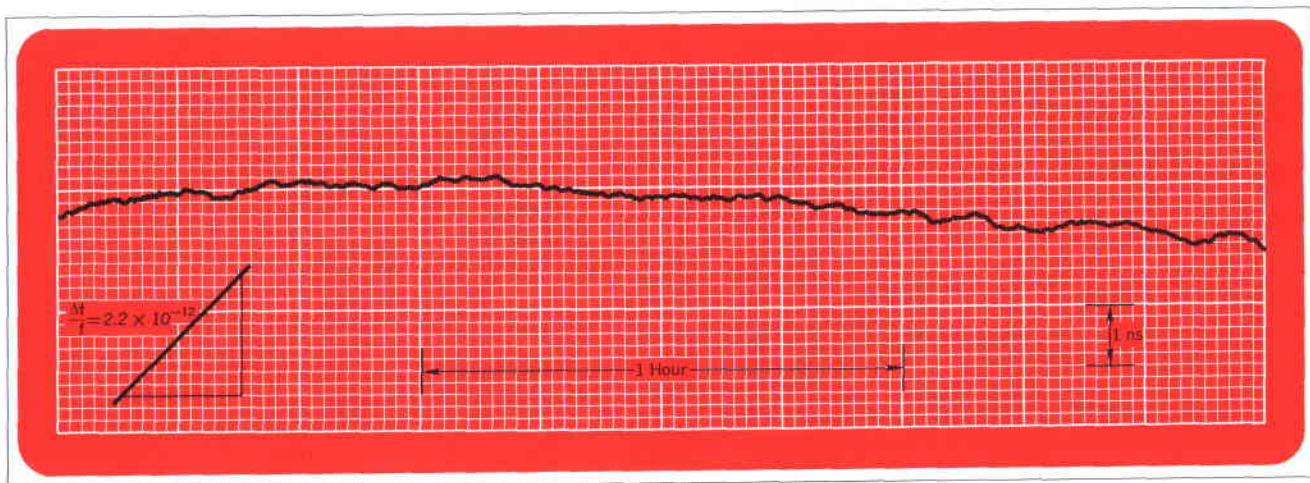

Fig. 8. Record of typical stability of new standard made by comparing phase of output signal with that of output of hydrogen maser (comparison made at 100 MHz). High stability of new standard is shown by comparing with slope of  $2.2 \times 10^{-12}$  reference line.

corresponding to a frequency offset of  $2.2 \times 10^{-12}$ . To evaluate the plot, the 'instantaneous' slope of the fine structure can be compared with the reference line. The long averaging time data for the rubidium-standard stability curve in Fig. 3 were derived from this record by averaging the phase change for various intervals.

In the measurement arrangement (Fig. 9) used to make the phase difference plot, the 5-MHz output of the standard was multiplied some 20 times, as was the output of a hydrogen maser of the same frequency. This provides two frequencies near 100 MHz. The phase difference between these signals was measured by applying the signals to an HP Model 8405A Vector Voltmeter whose output then fed an analog recorder.

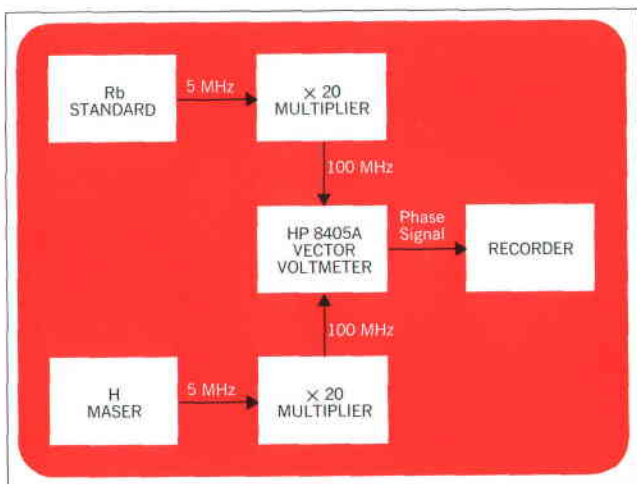

Fig. 9. Equipment arrangement used in making record of Fig. 8.

### Time Scale Changes

A special objective in the new standard was to provide for simple means of changing time scales. Two time scales are presently in wide usage. One of these, the 'atomic time' scale, was defined by the 13th General Conference on Weights and Measures, stating it is to be determined by the transition between two hyperfine levels of the ground state of cesium.\*

The second time scale is the UTC or Universal Time Scale. This is related to the rotation of the earth and is set yearly in international agreement. For the years 1966 through 1968 this scale has been 300 parts in  $10^{10}$  longer than the atomic scale.

The arrangement shown in Fig. 10 has been used in the standard to facilitate changes of time scale. Fig. 10 shows a detail of the synthesizer portion of the diagram of Fig. 4. The output frequency of the synthesizer circuitry is controlled by four thumbwheel switches. These switches control the four preset decade dividers in Fig. 10 and thereby determine the appropriate subharmonic of 5 MHz for comparison with the 5.316 . . . MHz oscillator frequency in the phase detector. The control voltage out of the phase detector thus locks the VCXO to a harmonic  $M$  of  $\frac{5}{N}$  MHz which has the stability of the main crystal oscillator. The circuitry is such that adjustments of frequency in steps of approximately  $1 \times 10^{-9}$  can be made by the thumbswitches. Finer adjustments are made by changing the magnetic field inside the optical package. This is implemented by a potentiometer

\* 'Atomic Second Adopted by International Conference,' *Hewlett-Packard Journal*, Vol. 19, No. 6, February, 1968.

which controls the field bias so as to provide a linear frequency change with dial reading. Fig. 11 shows a typical plot of frequency change as a function of dial reading. The maximum deviation from a straight line is only  $2.5 \times 10^{-11}$  over a range of  $2 \times 10^{-9}$ . The overall range is adjusted at the factory to provide a change of  $2 \times 10^{-9}$  full scale.

### Warm-Up Characteristics

A particular advantage of a rubidium standard is that its warmup characteristic is much faster than that of precision crystal standards. Fig. 12, for example, shows the measured warmup of two of the new rubidium standards after they were baked in a  $70^\circ\text{C}$  oven for 24 hours. As a starting-point for a warmup test, this constitutes a 'worst-case' condition. After 1 hour of warmup the standards were within  $1 \times 10^{-10}$  of the original frequency and after 15 hours they were within  $1 \times 10^{-11}$ . After 30 hours one standard was within  $9 \times 10^{-12}$  of its pre-storage frequency; the second was within  $7 \times 10^{-12}$  of its pre-storage frequency.

### Time Pulse Output

Circuitry has been designed so, if desired, the standard will deliver a time pulse at the rate of 1 pps for situations where time information is to be provided by the standard. A master pulse is derived from the 1 MHz signal available in the standard and is divided to 1 pps by a set of six integrated-circuit decade dividers. This pulse is used to preset a second set of six decade dividers.

The output pulse to the front panel is controlled by the second set of six decades and thumbwheel switches. By this means the output pulse can be delayed up to 1 second for phasing purposes. In addition, the output pulse can be automatically synchronized with an external pulse by applying the external pulse to a rear panel jack and pressing the 'sync' button on the digital divider. This

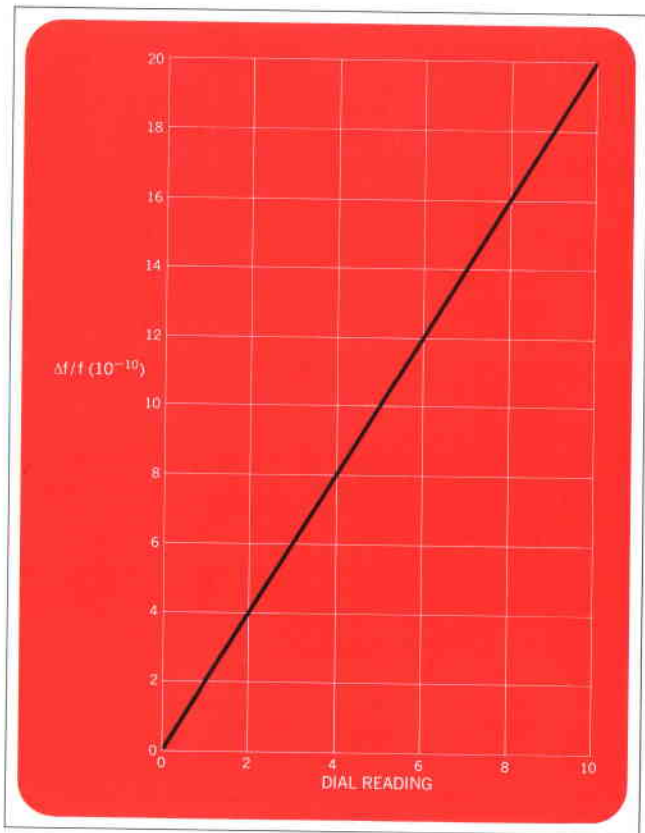

Fig. 11. A special provision in the new standard is that the output frequency is adjustable by means of a calibrated dial. Above curve shows typical linearity of dial's effect on output frequency.

technique synchronizes the output pulse to within  $10 \pm 1$  microseconds with respect to the external reference pulse.

The optional divider circuitry also operates a 24-hour clock movement on the instrument front panel.

### Battery Operation

One version of the instrument is operated by a battery in a standby arrangement. The battery is automatically

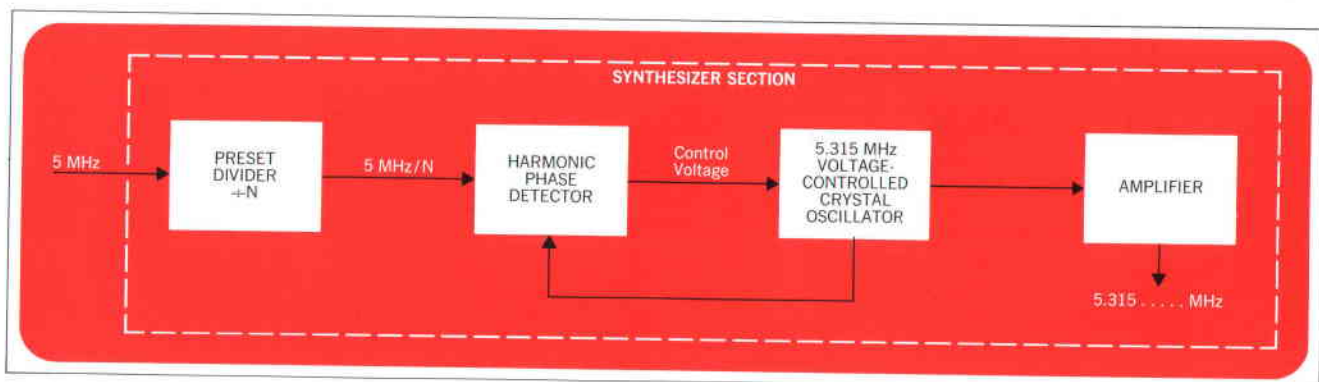

Fig. 10. Diagram of circuit arrangement of synthesizer portion of new standard's circuit.



### Darwin H. Throne

During his studies at the University of Minnesota, Darwin Thorne did research in cosmic radiation, studying light nuclei in primary radiation for his Master's thesis and working on other cosmic-ray programs during summer periods. In 1965, after receiving BSEE and MS degrees at Minnesota U., he joined the HP Frequency and Time Division development laboratory where he has since performed development work on the new Rubidium-Vapor Frequency Standard. Darwin is a member of Tau Beta Pi and Eta Kappa Nu.

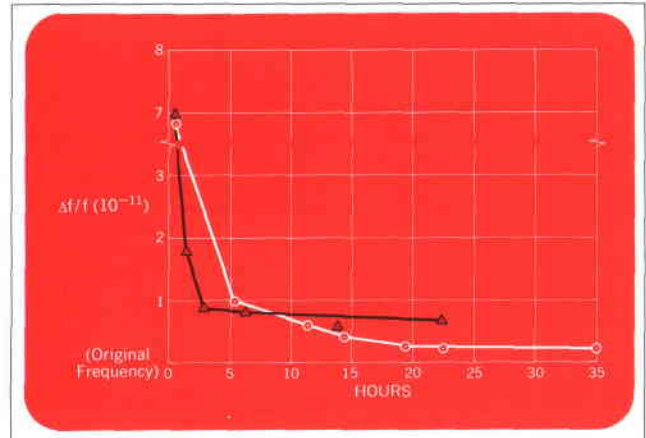

Fig. 12. Warmup characteristic of two rubidium standards measured under worst-case conditions. Warmup is fast enough that standards may be used in only about one hour after turn-on.

switched into operation in case of ac-power failure and provides at least 15 minutes of standby power. A battery warning light indicates failure of ac power. The battery can be charged by means of a switch on the panel.

### Acknowledgments

Much credit is due to Ilhan Gozaydin who was the mechanical engineer and product designer on the project. Ilhan also analyzed much of the short-term stability data.

Credit is also due to B. E. Swartz who did much of the electronics design.

Richard A. Baugh did much of the development of the optical package and was the original group leader on the project.

Bruce Fowler acquired most of the long-term aging data on the gas cells and is also assisting with the production of the HP Model 5065A. Rex Brush assisted in the analysis of the short-term stability data.

## SPECIFICATIONS

### HP Model 5065A

#### Rubidium-Vapor Frequency Standard

##### FREQUENCY STABILITY:

LONG TERM:  $< 2 \times 10^{-11}$  per month (maximum limit of drift rate).

SHORT TERM:	Averaging Time	$\frac{\Delta f}{f}$ Standard Deviation
	1 ms	$< 6 \times 10^{-10}$ rms
	10 ms	$< 1 \times 10^{-10}$
	.1 s	$< 1.5 \times 10^{-11}$
	1 s	$< 5 \times 10^{-12}$
	10 s	$< 1.5 \times 10^{-12}$
	100 s	$< 5 \times 10^{-13}$
	1000 s	$< 5 \times 10^{-13}$

CALIBRATION ACCURACY: Set at factory to  $< \pm 1 \times 10^{-11}$  of specified time scale.

TIME SCALE: Set at factory to UTC unless specified differently.

##### TUNABILITY:

COARSE FREQUENCY SYNTHESIZER ADJUSTMENT: RANGE:  $1000 \times 10^{-10}$  referenced to atomic time scale.

RESOLUTION:  $< 2 \times 10^{-9}$ , thumbwheel adjustable.

FINE FREQUENCY MAGNETIC FIELD ADJUSTMENT: RANGE:  $2 \times 10^{-4}$ .

RESOLUTION:  $2 \times 10^{-12}$ .

WARM-UP: Operational in one hour after 24 hours 'off' time.

##### OUTPUTS:

FREQUENCIES: 5 MHz, 1 MHz, 100 kHz and isolated 100 kHz clock drive for external clocks.

VOLTAGE LEVELS: 1 V rms into 50 ohms at 5 MHz, 1 MHz, 100 kHz; 0.5 V rms into 1000 ohms at 100 kHz, clock drive.

CONNECTORS: BNC Front and Rear for 5 MHz, 1 MHz, 100 kHz; BNC Rear for 100 kHz clock drive.

\* All units aged to meet this specification before shipment.

HARMONIC DISTORTION: (5 MHz, 1 MHz, 100 kHz)  $> 40$  dB down from rated output.

NON-HARMONIC DISTORTION: (5 MHz, 1 MHz, 100 kHz)  $> 80$  dB down from rated output.

SIGNAL-TO-NOISE RATIO: For 1 and 5 MHz,  $> 87$  dB at rated output (in a 30 kHz noise bandwidth, 5 MHz output filter bandwidth is approx. 100 Hz); for 100 kHz,  $> 60$  dB in 30 kHz noise bandwidth.

##### Quartz Oscillator Only

(Rubidium Vapor Resonator Turned Off)

AGING RATE:  $< 5 \times 10^{-10}$  per 24 hours.

##### FREQUENCY ADJUSTMENTS:

FINE ADJUSTMENT:  $5 \times 10^6$  range, with dial reading parts in  $10^9$ .

COARSE ADJUSTMENT: 1 part in  $10^6$ , screwdriver adjustment at front panel.

##### STABILITY:

AS A FUNCTION OF AMBIENT TEMPERATURE:  $< 2.5 \times 10^{-9}$  total from  $0^\circ$  to  $+50^\circ\text{C}$ .

AS A FUNCTION OF LOAD:  $< 2 \times 10^{-11}$  for open circuit to short, and 50  $\Omega$  R, L, C load change.

AS A FUNCTION OF SUPPLY VOLTAGE:  $< \pm 5 \times 10^{-11}$  for 22 to 30 V dc, or for 115/230 V ac,  $\pm 10\%$ .

##### General Specifications

##### ENVIRONMENTAL

TEMPERATURE, OPERATING:  $0^\circ$ - $50^\circ\text{C}$ . Stability is  $< \pm 5 \times 10^{-11}$  over this range.

TEMPERATURE, NON-OPERATING:  $-40^\circ$  to  $+75^\circ\text{C}$ .

##### TESTS PASSED BY UNITS:

HUMIDITY: 0 to 95% relative humidity.

MAGNETIC FIELD:  $< 1 \times 10^{-11}$  change for 1 gauss change in uniform magnetic field.

VIBRATION: MIL-Std-167.

ELECTROMAGNETIC COMPATIBILITY (EMC):

MIL-1-6181D.

POWER: 115 V/220 V rms  $\pm 10\%$ , 50 to 400 Hz or 22 to 30 V dc.

APPROXIMATE INPUT: 33 watts dc.

WITH OPTION 01: Add 8 watts.

WITH OPTION 02: No additional power.

DIMENSIONS: 5 1/4 in. high; 16 3/4 in. wide; 16 1/2 in. deep.

WEIGHT: Net, 37 lb; Option 01 add 2 lb; Option 02 add 3.5 lb.

PRICE: \$7,500.00.

##### Option 01 Time Standard

##### CLOCK PULSE:

RATE: 1 pulse per second.

AMPLITUDE:  $+10$  V peak  $\pm 10\%$ .

WIDTH: 20  $\mu\text{s}$  min.

RISE TIME:  $< 50$  ns.

FALL TIME:  $< 1 \mu\text{s}$ .

JITTER:  $< 20$  ns.

All specs are with 50  $\Omega$  load.

SYNCHRONIZATION: 10  $\mu\text{s}$  ( $\pm 1 \mu\text{s}$ ) delayed from reference input pulse (rear BNC). Reference pulse must be  $> +5$  V, with a rise time  $< 50$  ns.

CLOCK MOVEMENT: 24 hrs., Patek Philippe.

PRICE: Option 01, add \$1,500.00.

##### Option 02 Standby Power Supply

CAPACITY: 15-minute minimum at  $25^\circ\text{C}$  after full charge.

CHARGE CONTROL: Front panel Fast-Float-Reset charge switch.

INDICATOR: A front panel light flashes when ac power is interrupted and battery is being used.

PRICE: \$300.00.

##### Option 03

(Combines Options 01 and 02)

PRICE: Option 03, add \$1,800.00.

MANUFACTURING DIVISION: HP FREQUENCY AND

TIME DIVISION

1501 Page Mill Road

Palo Alto, California 94304

# Comparing Frequency Standards

Four types of precision frequency standards are in wide use today. They are:

- Quartz crystal oscillators
- Rubidium-gas-cell-controlled oscillators
- Cesium-beam-tube-controlled oscillators
- Hydrogen masers.

No single type is best for all applications. The following tables and charts summarize the advantages, limitations, and characteristics of presently available standards and indicate some of their more frequent uses.

## Advantages, Limitations, and Uses of Precision Frequency Sources

	Quartz Crystal Oscillator	Rubidium-Gas-Cell-Controlled Oscillator	Cesium-Beam-Tube-Controlled Oscillator	Hydrogen Maser
<b>Description</b>	Active oscillator. Frequency determined by quartz crystal.	Output derived from quartz oscillator. Frequency determined by passive atomic resonator.	Output derived from quartz oscillator. Frequency determined by passive atomic resonator.	Active atomic oscillator. Frequency determined by atomic resonance of hydrogen.
<b>Advantages</b>	Low-cost, compact light-weight, good short-term stability (< 100 s).	Compact, light-weight, lower cost than cesium or hydrogen, good short-term stability with lower drift rate than quartz oscillator.	Compact, portable. Excellent long-term stability. Primary standard — has high intrinsic reproducibility. Relatively free from environmental and systematic variations.	Most stable oscillator known, long or short term. Primary standard — has high intrinsic reproducibility.
<b>Limitations</b>	Systematic drift (aging). Secondary standard — needs periodic calibration against primary standard.	Secondary standard — needs periodic calibration against primary standard.	Short-term stability in range 0.1 to 100 seconds, when time constant of loop is made short to increase environmental immunity. Higher cost than quartz or rubidium.	Size, weight, cost.
<b>Uses</b>	Frequency and time standards. Spectral analysis of oscillators and multipliers. Microwave spectroscopy. Doppler measurements. Communications and navigation systems. Systems which multiply the output frequency many times.	Communications systems. Narrow-band and security systems. Aircraft collision-avoidance systems. Doppler radar. Radar and radio astronomy, including long-baseline interferometry. Coherent signal sources. Precision timekeeping. House frequency standards. Calibration laboratories.	Present U. S. frequency and time standards. 'Flying clocks.' Timekeeping with microsecond accuracy. House standards. Radio and radar astronomy, including long-baseline interferometry. Navigation systems. Doppler space-probe tracking. Propagation studies.	Radio and radar astronomy (especially very-long-baseline interferometry). Super-accurate timekeeping. Deep-space tracking. Tests of Einstein's theory of relativity. Extremely stable frequency source.

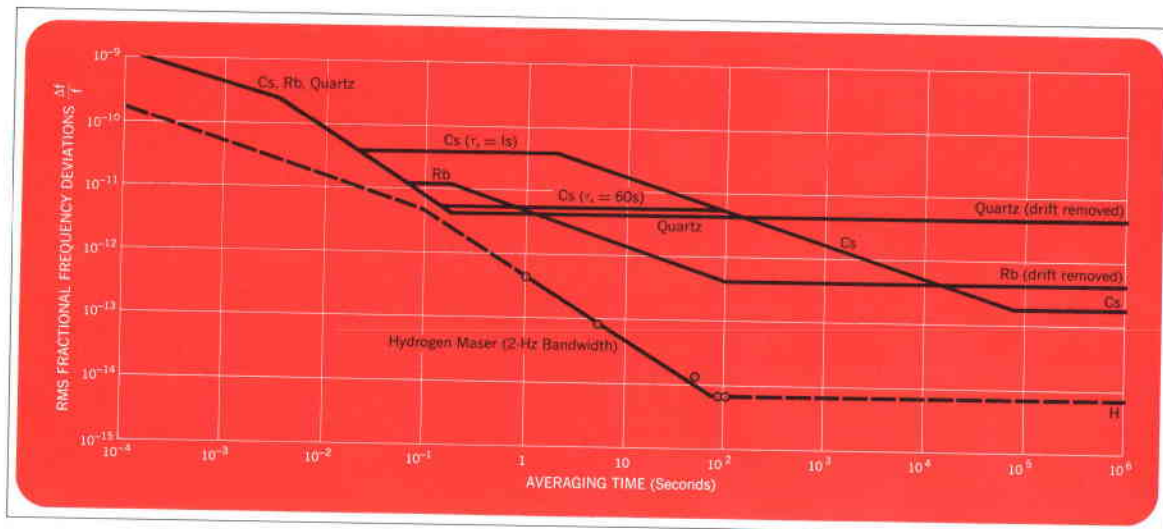

Typical stability curves for HP 5061A Cesium-Beam Frequency Standard (two loop time constants:  $\tau_0 = 1$  second or 60 seconds), HP 5065A Rubidium-Vapor Frequency Standard (drift removed), and HP 105A Quartz Oscillator (drift removed), and latest stability measurements for HP Hydrogen Maser (under development).

## Characteristics of Precision Frequency Sources

	Quartz Crystal Oscillator	Rubidium-Gas-Cell- Controlled Oscillator	Cesium-Beam-Tube- Controlled Oscillator	Hydrogen Maser
<b>Model</b>	<b>HP 105A</b>	<b>HP 5065A</b>	<b>HP 5061A</b>	<b>HP (see reference 7)</b>
<b>Resonator Frequency</b>	5 MHz	6834.682 608 MHz	9192.631 770 MHz	1420.405 751 786 4 MHz
<b>Systematic Drift</b>	$< 5 \times 10^{-10}$ per 24 hr	$< 2 \times 10^{-11}$ per month	None detected within resolution of current measurements. Estimated at $< 3 \times 10^{-12}$ for life.	None detected within resolution of current measurements. Estimated at $< 1 \times 10^{-12}$ for life.
<b>Short-term Stability (rms fractional frequency fluctuations for typical units in constant environments)*</b> <b>Averaging Time:</b>			Loop time constant $\tau_0 =$ 1 s      60 s	
<b>1 ms</b>	$5 \times 10^{-10}$	$5 \times 10^{-10}$	$5 \times 10^{-10}$ $5 \times 10^{-10}$	—
<b>10 ms</b>	$1 \times 10^{-10}$	$1 \times 10^{-10}$	$1 \times 10^{-10}$ $1 \times 10^{-10}$	—
<b>100 ms</b>	$1 \times 10^{-11}$	$1.5 \times 10^{-11}$	$4 \times 10^{-11}$ $1 \times 10^{-11}$	$5 \times 10^{-12}$ Extrapolated
<b>1 s</b>	$5 \times 10^{-12}$	$5 \times 10^{-12}$	$4 \times 10^{-11}$ $5 \times 10^{-12}$	$5 \times 10^{-13}$ Measured
<b>1 min</b>	$5 \times 10^{-12}$	$6 \times 10^{-13}$	$7 \times 10^{-12}$ $5 \times 10^{-12}$	$7 \times 10^{-15}$ Measured
<b>1 hr</b>	$5 \times 10^{-12}$	$5 \times 10^{-13}$	$1 \times 10^{-12}$ $1 \times 10^{-12}$	$7 \times 10^{-15}$ Estimated
<b>1 day</b>	—	$5 \times 10^{-13}$	$2 \times 10^{-13}$ $2 \times 10^{-13}$	$7 \times 10^{-15}$ Estimated
<b>Volume</b>	0.38 ft <sup>3</sup>	0.83 ft <sup>3</sup>	1.4 ft <sup>3</sup>	13.3 ft <sup>3</sup>
<b>Weight</b>	16 lb	37 lb	60 lb	600 lb
<b>Power Consumption (115 Vac)</b>	17 W	48 W	43 W	150 W
<b>Cost</b>	\$1500	\$7500	\$14,800	Not presently commercially available.

\*Systematic drift removed from quartz and rubidium figures.

### Bibliography

1. A. O. McCoubrey, 'A Survey of Atomic Frequency Standards,' Proceedings of the IEEE, Vol. 54, No. 2, February 1966.\*
2. L. S. Cutler and C. L. Searle, 'Some Aspects of the Theory and Measurement of Frequency Fluctuations in Frequency Standards,' Proceedings of the IEEE, Vol. 54, No. 2, February 1966.\*
3. L. N. Bodily, 'A Survey of Some Performance Characteristics of a Large Number of Cesium-Beam Frequency Standards,' **Hewlett-Packard Journal**, Vol. 18, No. 2, October 1966.
4. R. Vessot, H. Peters, et al., 'An Intercomparison of Hydrogen and Cesium Frequency Standards,' IEEE Transactions on Instrumentation and Measurement, Vol. IM-15, No. 4, December 1966.
5. R. E. Beehler, 'A Historical Review of Atomic Frequency Standards,' Proceedings of the IEEE, Vol. 55, No. 6, June 1967.
6. A. O. McCoubrey, 'The Relative Merits of Atomic Frequency Standards,' Proceedings of the IEEE, Vol. 55, No. 6, June 1967.
7. R. Vessot, M. Levine, et al., 'Progress in the Development of Hydrogen Masers,' presented at the 22nd Annual Symposium on Frequency Control, Atlantic City, N. J., April 22-24, 1968. See also Frequency, July 1968.
8. D. H. Throne, 'A Rubidium-Vapor Frequency Standard for Systems Requiring Superior Frequency Stability,' this issue.

\* Many other papers on frequency stability can be found in this issue of the Proceedings of the IEEE.

**HEWLETT-PACKARD JOURNAL** **JULY 1968** Volume 19 • Number 11

TECHNICAL INFORMATION FROM THE LABORATORIES OF THE HEWLETT-PACKARD COMPANY PUBLISHED AT 1501 PAGE MILL ROAD, PALO ALTO, CALIFORNIA 94304  
Editorial Staff: F. J. BURKHARD, R. P. DOLAN, L. D. SHERGALIS, R. H. SNYDER Art Director: R. A. ERICKSON

# HP Archive

This vintage Hewlett-Packard document was  
preserved and distributed by

**[www.hparchive.com](http://www.hparchive.com)**

Please visit us on the web!

On-line curator: John Miles, KE5FX

[jmiles@pop.net](mailto:jmiles@pop.net)

