

HP

SEPTEMBER 1995

# Professional

SPECIAL SECTION  
HP'S CHANNEL  
PARTNERS

Page 31

# DCE/9000

Plug Into The Future Of Computing

**INDUSTRY WATCH:**

- 64-Bit UNIX API Initiative
- HP's Third Quarter Financials
- New Home PCs From HP

8:30 AM

Arrive at work. Hear strange noise down the hall.

8:35 AM

Tiptoe down hallway to investigate.



8:37 AM

It's the printer trying to speak.

8:38 AM

It's Greek to you.  
But you bought IBM, so you get IBM service.

9:36 AM

They arrive to translate. Printer's saying,  
"Clean my print head."

10:29 AM

Heads are rolling. But not yours.  
Thanks IBM.

Guaranteed response time. A preventive maintenance program to make sure supplies get replenished and printers get cleaned, cared for and just checked out. Now you have a better idea of why our customers sleep well. Whatever your client/server printing needs, we have nine laser and impact workhorses to meet them. Such as our 400-, 800-, and 1200-lpm impact printers: all strong, silent types (only 52 dBA), ideally suited for heavy, continuous use, that you can plug and play on virtually any platform. To enhance your peace of mind with more information on our products and services, call 1 800 IBM-3333, ext. 1A031. Or find us on the Internet at [printers@vnet.ibm.com](mailto:printers@vnet.ibm.com)



The IBM logo can be found on the Internet at <http://www.ibm.com>. IBM is a registered trademark of International Business Machines Corporation. © 1995 IBM Corporation.



**THE  
WORKSTATION  
MEMORY  
CREATED LIKE  
NO OTHER**

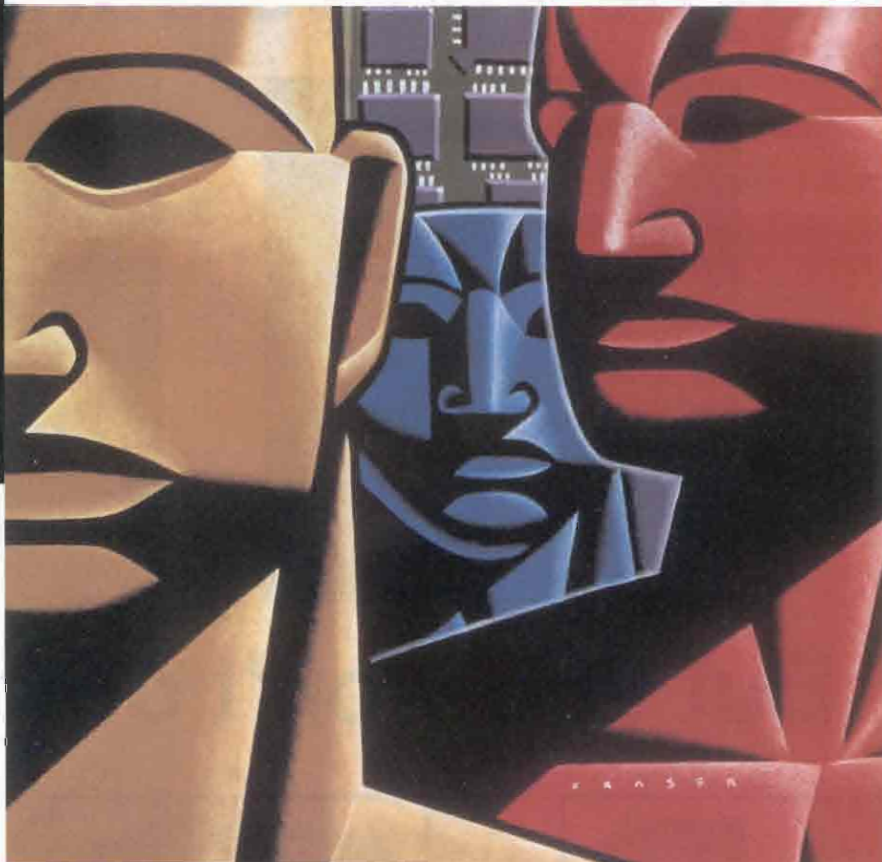

**K**ingston's workstation memory upgrades lead the industry in competitive pricing, reliability, compatibility, selection and availability.



Our workstation memory is backed by a lifetime warranty and free, comprehensive technical support. We test every memory

upgrade with the systems' own diagnostics and operating systems.



At Kingston 100% compatibility is guaranteed.



**KINGSTON MANUFACTURES MEMORY FOR:**

- DATA GENERAL
- DEC
- HEWLETT-PACKARD
- IBM
- NCD
- SILICON GRAPHICS
- SUN

For more information, contact our workstation experts at:

**(800) 435-0669**



DEC ALPHA 3000AXP Memory  
32MB, 64MB, 128MB, 256MB



HP/Apollo Series 9000 Model 750, 755 Memory  
32MB, 64MB, 128MB



Challenge™ & Onyx™ Memory  
64MB, 256MB

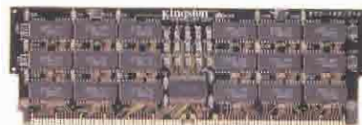

SPARC System 10 Memory  
16MB, 64MB

**Kingston**  
TECHNOLOGY CORPORATION

THE INSIDE NAME IN UPGRADES

17600 Newhope Street, Fountain Valley, CA 92708  
(714) 435-2667 Fax (714) 435-2618

All Trademarks and Registered Trademarks are of their respective holders. Kingston is a Registered Trademark of Kingston Technology Corporation.

**CIRCLE 281 ON READER CARD**

# Maybe you've outgrown this,

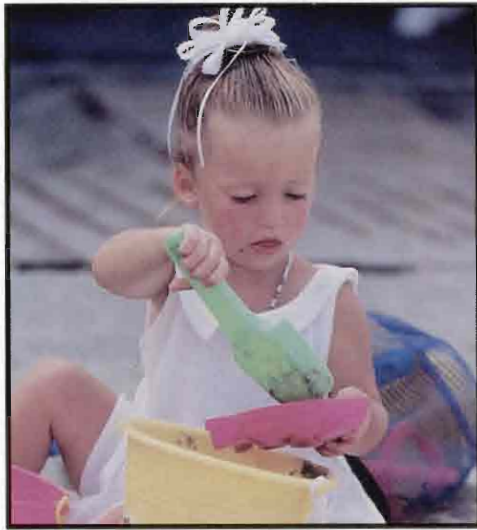

## But you won't outgrow this.



"It was fun while it lasted" is something you can say about your childhood, but should never have to say about your computer storage and backup solutions. And, with IEM's Building Block product line, you won't have to. Building Block products are modular, interchangeable devices which offer you unlimited combinations and configuration flexibility. The system is comprised of building blocks and enclosures.

Building blocks are 8mm, 4mm, DLT, CD-ROM, multifunction optical, floppy, and winchester units encased in carriers with the SCSI and power cables built-in. Enclosures are equipped with pre-configured SCSI backplanes and are available with 3-slots, 7-slots, 70-slots, or 168-slots.

The building blocks slide easily in and out of each enclosure. So, as the building block slides into place, all of the SCSI and power connections are made and the building blocks are hot-swappable in the event of failure (you don't even have to power the system down!).

As your needs outgrow one enclosure, all or some of the building blocks can be transferred to the next largest enclosure. IEM's Building Blocks grow with your needs.

Call us today and ask about **RAID!**

CIRCLE 122 ON READER CARD



©1995 Anis Inc. L2.0595

In the U.S. and Canada:  
IEM, Inc., P.O. Box 1889  
Fort Collins, CO 80522 USA  
Phone: (970) 221-3005  
(800) 321-4671  
Fax: (970) 221-1909  
E-Mail: info@iem.com

In the United Kingdom:  
IEM, Inc., Colorado House,  
Cromwell Park, Banbury Road  
Chipping Norton, Oxfordshire  
OX7 5SR  
Phone: +44 (0)1608 645000  
Fax: +44 (0)1608 645155

All Others:  
IEM International Sales  
1629 Blue Spruce Drive  
Fort Collins, CO 80524 USA  
Phone: +[1] 970-221-3005  
Fax: +[1] 970-221-1909  
E-Mail: info@iem.com

# Contents

September 1995

Vol. 9, No. 9

## DCE 101

By Marty Poniatowski

*Because you can obtain Distributed Computing Environment (DCE) components from a variety of manufacturers, DCE may be the best framework on which to build your applications. And the more heterogeneous your environment the more DCE will help you.*

22

## Out Of The Muddle And Into The Middle

By David Baum

*When it comes to internetworking, most companies are on their way to combining HP 9000s, HP 3000s and PCs into an interoperable infrastructure. However, how do you create application-to-application communications? Would you believe middleware?*

24

### COLUMNS

#### Industry Watch:

By George A. Thompson

HP's 3Q Results; 64-bit UNIX API; HP's PCs Move Into Your Home; Plan 9 From AT&T; Digital/Microsoft Relationship; Book Reviews . . . . . 9

#### Network Management: HP OpenView Users: Cautiously Optimistic

By Jill Huntington-Lee

With Tornado Blowing In The Wind, HP Sets Practical, Short-Term Goals For Network Management . . . . . 40

#### PC Tips: The Hype And The Hope Of 95

By Miles B. Kehoe

Windows 95: An Exercise In Wait Management . . . . . 42

#### Integrating Your HP 3000: The Dark Side Of The Force

By John P. Burke

Will The HP 3000 Be Able To Anticipate And Meet The Needs Of Future Generations . . . . . 44

#### & Another Thing . . .

HP Professional Editorial Calendar Reader Survey. Now's Your Chance To Tell Us What You Like Best And Least About HP Professional. Please E-mail, Fax [(215) 643-4827] Or Mail The Survey To: HP Professional, 1300 Virginia Drive, Suite 400, Fort Washington, PA 19034. . . . . 72



Editorial . . . . . 7

Letters . . . . . 14

New Products . . . . . 49

Reader Information . . . . . 65

Product Showcase . . . . . 68

Advertiser Index . . . . . 71

### PRODUCT WATCH:

Palindrome Corp.'s Backup Director 4.0 . . . . . 16

Template Software's Workflow Template 3.0 . . . . . 18

### STRATEGIC DIRECTIONS:

Hermes Softlab . . . . . 20



Cover Photo By Superstock



Memory upgrades,  
disk, tape, and  
optical drives,  
RAID arrays, and  
CD-ROMs — all for  
Silicon Graphics and  
Hewlett-Packard  
workstations —  
all from LEGASYS.

# Full Service.

*(Sometimes the Best Ideas  
are Old Ideas.)*

Great customer service, for instance. At LEGASYS, we package old-fashioned service with state-of-the-art peripheral products for Silicon Graphics and Hewlett-Packard workstations.



Each LEGASYS product is equipped with a promise: if you experience a problem with a product under warranty, we'll ship a replacement within 48 hours. And we're speedy on original orders also. We ship most products within a day of receipt of order.

At LEGASYS, we're international in scope and our products are on the leading edge of technology, but our way of doing business is strictly down-home.

For ordering and product information call 1-800-955-4229 or 303-469-6114. Otherwise, fax 303-469-4699 or e-mail [inquire@legasys.com](mailto:inquire@legasys.com).



For free shipping on your first order, ask for extension 54.



*The Peripheral Vision of the Future*

Authorized Silicon Graphics  
Independent Hardware Developer



CIRCLE 452 ON READER CARD

## HP Professional

**EDITOR-IN-CHIEF** Charlie Simpson  
[simpsoncm@box101.cardinal.com](mailto:simpsoncm@box101.cardinal.com)  
**TECHNICAL EDITOR** George A. Thompson  
[thompsonga@box101.cardinal.com](mailto:thompsonga@box101.cardinal.com)  
**ASSISTANT EDITOR** Deborah Schwartz  
[schwartzdr@box101.cardinal.com](mailto:schwartzdr@box101.cardinal.com)

### COLUMNISTS

**NETWORKING MANAGEMENT** Jill Huntington-Lee  
**NETWORKING PCS** Jim Carr  
**PC/UNIX** Miles B. Kehoe  
**UNIX SYS ADMIN** Fred McLett  
**STANDARDS** Gordon McLachlan  
**HP 3000** John P. Burke

**CONTRIBUTING AUTHORS** David Baum,  
Sam Dickey, Jim Esch, Judith Harper,  
Marty Poniatowski

**INTERNATIONAL EDITIONS EDITOR** Karine Simpson

### DESIGN & PRODUCTION

**EXECUTIVE DESIGN DIRECTOR** Leslie A. Caruso  
**ART DIRECTOR** Al Feuerstein  
**ASSOCIATE ART DIRECTOR** Jennifer Barlow  
**DESIGNER** Patty Wall

**PRODUCTION MANAGER** Bill Hallman

### CIRCULATION

**CIRCULATION MANAGER** Ron Langmacher  
**DIRECTOR OF FULFILLMENT** Majorie Pitrone  
**CIRCULATION DIRECTOR** Carrie Eisenhandler  
**CIRCULATION COORDINATOR** Doreen Schrack

### MARKETING

**PROMOTIONS DIRECTOR** Timothy M. Kraft  
**MARKETING MANAGER** Veronica L. Sutsko  
**SENIOR GRAPHIC DESIGNER** Christine Minder  
**GRAPHIC DESIGNER** Mark Broomell

**PUBLISHER** Leslie Ringe

### CARDINAL BUSINESS MEDIA, INC.

*PRESIDENT AND CHIEF EXECUTIVE OFFICER*

*Robert N. Boucher*

*CHIEF FINANCIAL OFFICER*

*Thomas C. Breslin*

*VICE PRESIDENT, PUBLISHING*

*R. Patricia Herron*

*VICE PRESIDENT, HUMAN RESOURCES*

*Dorothy J. Flynn*

*VICE PRESIDENT, SPORTS & MUSIC DIVISION*

*Thomas J. Morgan*

*VICE PRESIDENT, RETAIL DIVISION*

*Marianne Houston*

For more information on how to contact your sales representative, see page 71. For address changes and other subscription information, please call (708) 564-1385 or FAX (708) 564-9002. Editorial, advertising sales and executive offices at 1300 Virginia Dr., Ste. 400, Fort Washington, PA 19034 ■ (215) 643-8000 Corporate FAX (215) 643-8099.

HP PROFESSIONAL ISSN 0896-145X is published monthly by Cardinal Business Media Inc., 1300 Virginia Dr. Ste. 400, Fort Washington, PA 19034. Subscriptions are complimentary for qualified U.S. and Canadian sites. For reprints, contact Reprint Management Services, 505 E. Airport Rd., Lancaster, PA 17601; (717) 560-2001, FAX (717) 560-2063. Second Class postage paid at Fort Washington, PA 19034, and additional mailing offices. POSTMASTER: Send all correspondence and address changes to HP PROFESSIONAL, P.O. Box 3052, Northbrook, IL 60062. COPYRIGHT © 1995 by Cardinal Business Media Inc. All rights reserved. No part of this publication may be reproduced in any form without written permission from the publisher. All submitted manuscripts, photographs and/or artwork are sent to Cardinal Business Media, Inc. at the sole risk of the sender. Neither Cardinal Business Media, Inc. nor HP PROFESSIONAL magazine is responsible for any loss or damage. HP PROFESSIONAL is an independent journal not affiliated with Hewlett-Packard Company. HP and Hewlett-Packard are registered trademarks and HP PROFESSIONAL is a trademark of Hewlett-Packard Company.

Canada Post International Publication Mail (Canadian Distribution Sales Agreement #IPM0264431)

Printed in U.S.A.



### HP PROFESSIONAL EDITORIAL ADVISORY BOARD

Patrick A. Adamiak

*HP 3000 Product Marketing Manager*

Nigel Ball

*Marketing Director For HP's Central Systems Division*

Thomas W. Crowley

*Director of MIS at Barber Colman*

Frank Humphries

*Director of Marketing at HP Asia Pacific Ltd.*

Glenn Osaka

*General Manager of HP's Professional Services Organization*

John R. Logan

*Vice President of Aberdeen Group Inc.*

Michael J. Meinz

*Principal Technical Consultant at General Mills Inc.*

Bard F. White

*CIO and Worldwide Director of MIS for Spalding Sports Worldwide*

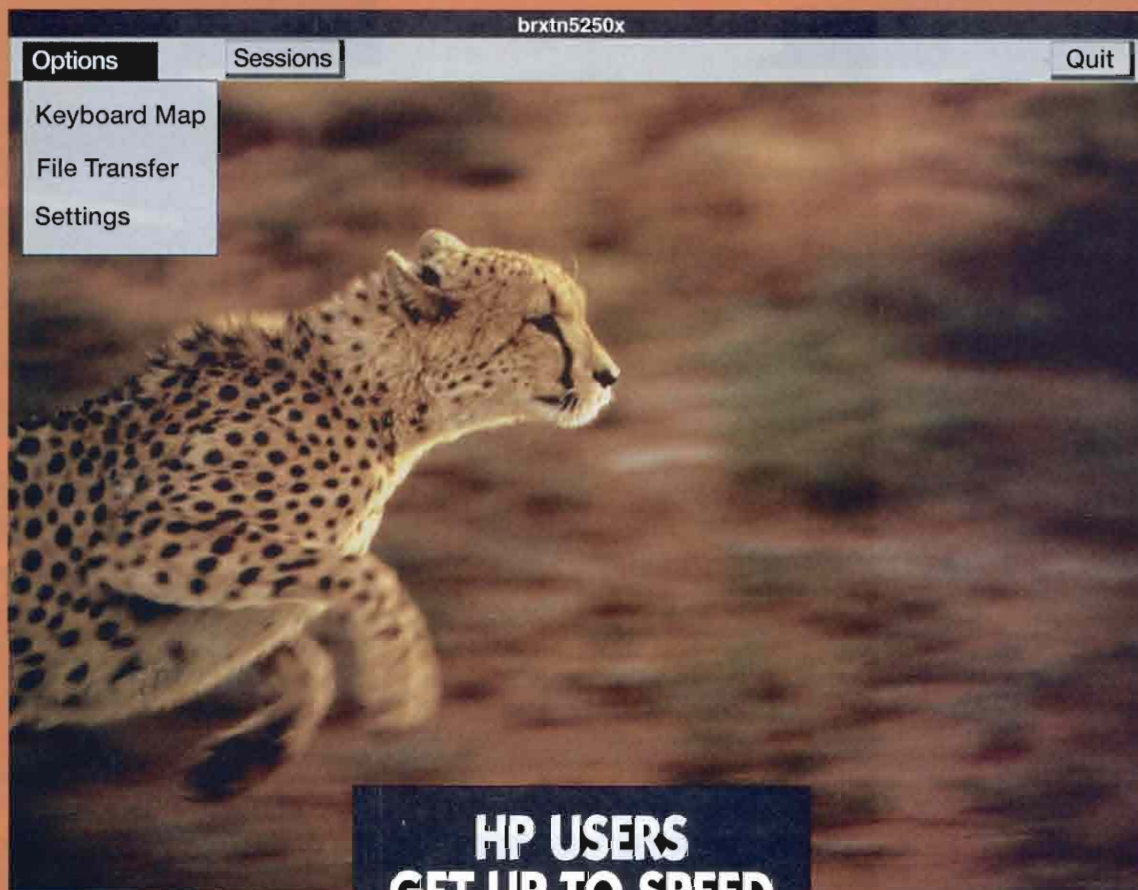

**HP USERS  
GET UP TO SPEED  
FAST WITH OUR  
5250 EMULATION.**

You'll get off to a running start when you choose the Brx5250 Open Client for HP9000 Series 700/800 workstations, from CNT/Brixton Systems.

Thanks to our GUI interface, the learning curve is swift. You get pull-down menus, X-windows environment, and cut-and-paste between all applications. So users can access AS/400 applications with productivity and ease from any HP-UX desktop. You also get file transfer, printer support and scalable fonts.

And to keep you ahead of the pack, the Brx5250 Open Client supports industry-standard Telnet servers and runs on nearly all

Unix systems, not just HP.

Since we also offer open software for 3270 emulation, powerful servers and other multi-platform SNA-to-Open Systems solutions, you can standardize on Brixton for all your connectivity needs.

That's why so many of the Fortune 100 are connecting with Brixton. Now it's your turn. Call today for free information. And learn how our "best of breed" software can help you be more competitive.

**The Cross Platform Leader**

*Brixton connectivity solutions run on:*

SunOS ■ Solaris 2.x  
IBM AIX ■ HP-UX  
DEC OSF/1

SCO UNIX ■ UnixWare  
Windows 3.x & NT

1-800-BRIXTON

*(<http://www.brixton.com>)  
All trademarks are the property of their respective owners.*

CNT/Brixton Systems, Inc., 125 CambridgePark Drive, Cambridge, MA 02140 USA

CIRCLE 220 ON READER CARD



### HP Series

	1MB	1	2	4	8	12	16	32	64	128	256
HP-200/310/320	●	●	●	●							
HP-319			●	●							
HP-330/350/370			●	●	●						
HP-332			●	●							
HP-340			●	●							
HP-345/375/380			●	●		●	●	●			
HP-360			●	●	●	●	●				
HP-362		●	●	●							
HP-382			●	●			●				
HP-400/425/433			●	●		●	●				
HP-425E			●	●		●	●				
HP-700RX	●	●	●	●							
HP-705/710			●	●		●	●				
HP-715/725			●	●		●	●	●			
HP-720/730/735						●	●	●	●	●	
HP-742/745/747			●	●		●	●	●	●	●	
HP-750/755						●	●	●	●	●	●
HP-8X7/9X7						●	●	●	●	●	●
HP-FXX/GXX/HXX/IXX						●	●	●	●	●	●

# PICK A CARD.

**Any card.** The memory you need is in stock, tested and ready to go. Order today. Upgrade your system tomorrow.

You'll get the quality and service you expect from the leader in HP workstation enhancements. We specialize in HP, it's the platform we know best.

Newport Digital TURBO cards and memory products are guaranteed to meet or beat HP quality standards. Every card we ship has been rigorously tested in a fully functional workstation, just like yours.

**Risk free.** Our total quality program gives us the confidence to offer an unconditional lifetime warranty. If one of our products fails, we'll ship a replacement by overnight express. We'll do anything we can to keep your workstation working.

**Call Today.** Speak with an expert on Hewlett-Packard computers. We'll make sure you get the cards you need.

Evaluate any of our memory products for 30 days. If you're not completely satisfied, return it without obligation.

**NEWPORT DIGITAL**  
**1-800-383-3642**

CIRCLE 246 ON READER CARD



# I Gotta Wear Shades

The future's so bright. That's the message from HP's upper echelon. At last month's Interex, in addition to the conference's keynote speech, Lew Platt, HP's chairman, president and CEO honored several editors, reporters, writers and journalists with a private luncheon and press conference. At both the keynote and press briefing, Platt offered HP users and the press members not only his impressions of the future but also a glimpse of HP's role in that computing future.

Platt referred to the "information highway" as an "Information Utility" where he envisions plugging in an "Information Appliance," a specialized piece of computing equipment, to perform one specific function, "much like ... a blow dryer or toaster." However, there will be no plugs or cables as everything will be wireless.

For example, Platt reiterated HP's MC<sup>2</sup> vision, citing the HP PalmVue (see *Industry Watch*, July 1995). When pressed to give a time frame for when the Information Utility will be an everyday household item, Platt hinted at having a little patience. Cautioning that there is still a way to go, Platt said, "Do you realize that 50 percent of the world has yet to make its first phone call. Not that they just don't own a phone, they haven't yet made a call."

Asked to speculate on the type of computer company that will be at the top of the heap in 10 years, Platt replied, "HP will be there." He then projected that companies which deliver their product to the mass market will endure and succeed. He mentioned HP's experiment to distribute HP's multimedia PCs to the home consumer via Circuit City retail stores.

As expected, the competition issue reared its head, starting with Digital, whom Platt felt posed no threat. However, when I asked Platt if he felt IBM was aggressively targeting HP he said, "IBM is clearly gaining momentum....They're very, very aggressively moving against us. It neither terrifies me nor does it give me a lot of comfort."

In a series of one-on-one interviews with *HP Professional* at Interex, Martin Clague IBM's "Client-Server Czar" said "hopefully" IBM is targeting all competitor's aggressively and are not just vindictive against HP. He further said that all vendors will have to work together to some degree if they hope to succeed in the future. Carol Mills, HP's general manager of GSY repeated that sentiment in a separate interview, agreeing that, "there needs to be some overlap of technologies and efforts."

Rich Sevcik, vice president and general manager of HP's Systems Technology Group, when asked about the future of computing, specifically the HP/Intel alliance, told *HP Professional* that there wasn't going to be much to talk about just yet. However, Sevcik felt that the new 64-bit UNIX API initiative announced on the first day of the conference will have a significant impact (see *Industry Watch* on page 18).

Even the HP 3000 was shining in HP's crystal ball. Olivier Helleboid, HP's general manager of CSY, gave his view of the HP 3000's future. When we asked if HP planned to market the HP 3000 in a niche or general business environment, Helleboid stated the HP isn't marketing the HP 3000 for the sake of the 3000. "It's the software that sells. The hardware hasn't changed." And "We're not positioning MPE/iX against UNIX — that's very hard to be successful."

As final evidence, on August 16, HP reported a 66 percent increase in net earnings, 34 percent growth in orders and a 28 percent increase in net revenue for its 1995 fiscal year's third quarter. There go those cheap sunglasses. Pass the Sun block.



**By Charlie Simpson**

*Charlie Simpson*

simpsoncm@box101.cardinal.com

# Camintonn Z-RAM.<sup>®</sup> Delivering Memory To The World.

Memory products for:  
*digital*  
HP Apollo  
IBM RISC  
Silicon Graphics  
SUN  
PCs and  
Laser Printers

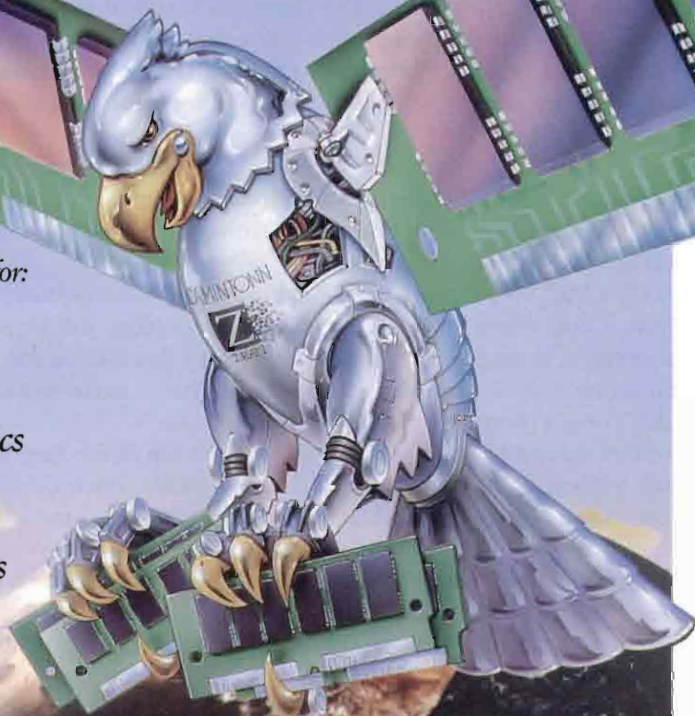

Camintonn Z-RAM customers come back again and again because of our 14-year record of proven leadership. Not just in high quality products, but also in prompt customer service, knowledgeable technical support, and a 24-hour repair-or-replace guarantee. Backed by a lifetime warranty.



And since Camintonn Z-RAM has the broadest line of memory products available, designed and rigorously tested in the United States, the quality product you need is ready for immediate delivery world-wide. What's more, we're almost always the first to offer 100% compatible memory for the newest systems – often before they're available from the original manufacturers.



Guaranteed performance and a 14-year track record of growth and financial stability. Call us at 1-800-368-4726 for an immediate quote for your system.



## **FREE** Camintonn Z-RAM Atlas Your Guide To The World Of Memory

Fax this form back to us and we'll send you a Windows version of The Automated Upgrade Guide – (3.5" disk) a \$49.95 value!

Name \_\_\_\_\_  
Title \_\_\_\_\_  
Company \_\_\_\_\_  
Street \_\_\_\_\_  
City/State/Zip \_\_\_\_\_  
Phone \_\_\_\_\_ Fax \_\_\_\_\_

Which computer platforms are currently in use at your company? (check all that apply)

DEC \_\_\_\_\_ SGI \_\_\_\_\_  
HP \_\_\_\_\_ SUN \_\_\_\_\_  
IBM \_\_\_\_\_ PC LANs \_\_\_\_\_

**CAMINTONN**<sup>®</sup>  
CORPORATION



The last word in memory<sup>®</sup>

Tel: 800/368-4726 or 714/454-1500  
Fax: 714/830-4726

U.K. Tel: 44/ 1 865-784747 • Fax: 44/ 1 865-784750

Camintonn Z-RAM world headquarters located at 22 Morgan, Irvine, CA 92718-2202. European headquarters located at Oxford Science Park, OX4 4GA, U.K. © 1995 Camintonn Corporation. Product and company names are trademarks or registered trademarks of their respective companies.

CIRCLE 294 ON READER CARD

## INDUSTRY WATCH

George A. Thompson

**FLAWLESS IN PALO ALTO**

HP reported a 66 percent increase in net earnings (\$576 million) and a 28 percent increase in net revenue (\$7.7 billion) for its 1995 fiscal year as well as a 34 percent growth in orders. Net revenue in the United States (\$3.4 billion) increased 21 percent; and 34 percent outside the United States compared with a year ago. But HP's other business divisions also posted strong numbers. "HP's flawless execution in a lot of different businesses is the story here," according to John Jones, computer market analyst for Salomon Brothers (San Francisco, Calif.). And that flawless execution has led to "order growth rates which are beyond anyone's wildest dreams," states Jones.

Demand for HP's computer products was evident across the board as orders rose 39 percent to \$6.3 billion. Orders for the test and measurement business (semiconductor test equipment, and services and consulting) increased 23 percent, the fifth consecutive quarter of growth in excess of 20 percent. Orders for HP's electronic component business (attributed to demand for indicators and displays, fiber-optic components and optocouplers) rose 44 percent, while orders in the analytical products group rose 9 percent. And medical product orders grew seven percent. Jones notes, with some amazement, that "More than 50 percent of HP's business segments are growing at 20 percent or better; some like the PC segment are growing at 70 to 75 percent." ●

**HOME SWEET HOME FOR HP**

After extensive test marketing of the "HP Multimedia PC" in Circuit City stores the past several months, HP officially introduced a PC for the home

market. Now known as the Pavilion PC line, it was promoted by Lew Platt, HP's CEO, at Interex in Toronto. "People don't know HP for PCs [in the home market] but they do know HP for printers. Our reliability and brand image with printers gives us something of an advantage." And that is going to help them, according to Rane Abhijeet, a senior analyst at Link

Resources (New York, N.Y.). "The consumer market is quite brand sensitive and the HP name has a positive association [in the consumer's mind] because of HP printers. In 1996, I can see four dominant vendors: Compaq, Packard Bell, HP and IBM."

Many analysts think that the new home PCs will help HP (now number six) achieve its goal of becoming one

**64-BIT UNIX API: THE SPECTOR OF ANOTHER SPEC**

Ever since UNIX crept out of Bell Labs back in the early '70s, the reports of a UNIX "standard" have been greatly exaggerated. For example, by 1982, there were some 220 UNIX versions. Now, yet another group of industry players (about 60 so far) have banded together to support a 64-bit UNIX API. The significant U.S. players include AT&T, DEC, HP, IBM, Novell, SGI, SunSoft and Unisys. Japanese and European companies in on the spec development include Fujitsu Ltd., Groupe Bull, ICL, NEC, Mitsubishi Oki Electric, Olivetti and Siemens-Nixdorf AG.

Unlike other UNIX standardization efforts, the 64-bit UNIX API group, includes two companies that can be considered UNIX-neutral bystanders: CPU maker, Intel and PC manufacturer, Compaq. "This is the first time that all the industry players have gotten together," says Intel Fellow, Richard Wirt. "Before the closest was SPEC 1170, which was driven by four companies. It also is a recognition that 64-bits is on the industry horizon." As far as the HP/Intel collaboration is concerned, "it's an acknowledgment that our work is proceeding."

Wirt, who is a member of the group, points out that Intel is not in the UNIX business per se, (although every vendor in the group is an Intel customer) so "we need to think about OS and application support to be successful." Consequently, Intel is acting as program manager, "making it happen, keeping everything on schedule and providing resources for documentation." Although a bit skeptical, Tom Kucharvy, president of Summit Strategies (Boston, Mass.), says "it doesn't force vendors to change something they already have." However, he points out that backward compatibility efforts for current 32-bit UNIX environments (which the group has pledged to maintain) will have to revolve around SPEC 1170, so certain vendor-specific extensions (or gaps) will have to be filled. "And it's not clear how that will be handled." Still, Kucharvy is taking a *cautiously* optimistic approach. "It's still too early to tell, but [for now] it's a positive move."

The group expects to comply with existing standards like XPC 4.2 (aka SPEC 1170) POSIX, SVID, CDE and X Windows and make the 64-bit spec public by the end of the year. After the spec is submitted to X/Open for general review, Wirt says enterprise issues like DCE, OMC, system management and software distribution also will be considered for the next iteration of the spec in the second quarter of 1996. "We are always glad to see the vendors come together on common specifications," says Peter Shaw, vice president of sales and marketing for the OSF (Cambridge, Mass.). According to Shaw, the OSF "saw that need a long time ago." Noting that OSF/1.1.3 was a 64-bit capable OS (now implemented as Digital UNIX) available in June 1994, "we understand the need for 64-bit APIs. It's good that the other vendors are catching up to that."

of the top five worldwide PC suppliers this year. And eventually one of the top three. According to Dataquest (San Jose, Calif.), HP PC shipments increased in the second quarter of 1995 (due to the home shipments) by over 50 percent. By the end of next year, HP is expecting that the home market will be a \$1 billion business for the company.

The new Pavilion PC (starting at a \$1,499), described as "hip" with a new user interface shell, a newly designed box and color-coded cables, are available through mass market retailers including Best Buy, CompUSA, OfficeMax, Staples, Computer City and Office Depot.

However, as reported in the May Industry Watch, the new PCs are the brainchild of HP's Home Products Division (HPD) and are strictly consumer machines, not designed for business users. However, during the same week as the new home PC introduction, HP cut the prices of its Vectra desktops by up to 18 percent, after similar moves by Compaq and IBM. HP also introduced a 100 MHz Pentium-based NetServer LC model and cut prices by up to 5 percent on other systems. ●

## FOR \$100 MILLION, DEC'S ENGINEERS DO WINDOWS

On August 2, DEC and Microsoft joined their corporate hands as Robert Palmer, DEC's chairman and CEO, and Bill Gates, Microsoft chairman and CEO, held a joint press conference announcing another milestone in the DEC/Microsoft relationship. DEC will train, "with substantial funding from Microsoft," at least 1,500 new Microsoft Certified Systems Engineers (CSE) within the next 24 months; that's in addition to an existing staff of 800 Microsoft CSEs at DEC. It's the largest Microsoft support team in the world, according to Gates. Microsoft, on the other hand, will help DEC integrate OpenVMS with Windows NT. The deal is mutually beneficial for both companies, according to Rick Whiting, senior analyst at Summit Strategies (Boston, Mass.) "DEC is riding Microsoft's success. But

Microsoft really needs DEC's service and support infrastructure to reach enterprise-type markets"

Other highlights include a commitment by Microsoft to produce software for the Alpha AXP platform; engineering cooperation; cross-licensing of patent

portfolios; joint marketing and field sales; and licensing of DEC's successful clustering technology for inclusion in future versions of Windows NT. Total estimated cost for Microsoft: \$50 to \$100 million. More importantly, the alliance also calls for Microsoft to provide interoper-

## Book Review

r o u n d u p

### Silicon Snake Oil: Second Thoughts On The Information Highway

by Clifford Stoll

1995; Doubleday

Dell Publishing Group,  
New York, N.Y. 257 pp.

ISBN 0-385-41993-7

\$22.00

Net-heads. Web-slingers. Cyber-punks. Lend me your modems. There's a message in this book just for you: Get up and away from your CPUs, keyboards and monitors. Stop washing yourself in the bit stream. And smell not the ether, but the oxygen. And let it be known, this heady advice comes, not from some right wing technophobic Luddite or left wing culture-saving academic. It's one of your very own — none other than Clifford Stoll, hacker extraordinaire (as well as spelunker, astronomer and radio repairman) and best selling author of *The Cuckoo's Egg*. In *The Cuckoo's Egg*, you may remember Stoll as the cyber-Columbo who tracked down a German spy ring operating on "The Net."

That reputation alone will probably get *Snake Oil* more attention than it deserves. But it is an important book, because it's part of a growing number of books questioning the social and cultural impact of the digitally-encoded world we now inhabit. In Stoll's case, it's an Internet insider reconsidering the

ways and means of the so-called I-way. Or as Stoll puts it in the preface: "The medium is being oversold, our expectations have become bloated, and there's damned little critical discussion of the implications of an online world."

Although he's right about our "bloated expectations" you'll still find there's still "damned little critical discussion" in this book too. That's because *Silicon Snake Oil* is much more a rumination by Stoll than an examination of the issues by him. "I began this meditation with a perplexed ambivalence toward com-

puters, networks, and the culture that enshrines them," he writes. OK, at least he's honest. What is disappointing is that he is no less perplexed and just as ambivalent at its conclusion — 13 chapters later. The only appendix is subtitled, "Not Quite A Bibliography." But I'm

guessing that's because what you get is not quite a book. For example, there's no table of contents — not too much to ask for when you're paying the \$22 cover price.

Nevertheless some of Stoll's musings, no matter how inconsistent, aren't without merit. Some are quite well-expressed and some border on the poetic. For example, he refers to the Internet as "an unreal universe, a soluble tissue of nothingness." Likewise he goes on: "A poor substitute it is, this virtual reality where frustration is legion and where — in the holy names of Education and



ability between DEC ALL-IN-1 and MailWorks with Microsoft Exchange (a groupware product similar to IBM/Lotus' Notes). Palmer said DEC would use Exchange internally.

Palmer expects DEC's 5 million existing mail users to take advantage of Exchange. However, Exchange is not a shipping product, so "its a bit of a gam-

ble," says Summit's Whiting. By contrast, there are already 2 million Lotus Notes users. Lotus, as a result of a strategic alliance with HP, has been bundling Notes on HP-UX-based servers for the first six months of this year. "The question for IS to ask," says Whiting, is "What's the migration strategy? How long will ALL-IN-1

continue as a product or will it just come to a dead end." ●

## SHADES OF ED WOOD

Did you ever think that UNIX might have been a technology left behind by extraterrestrial IS managers? Then get ready for Plan 9. In July, the Computer Research Center of AT&T Bell Laboratories announced the availability of Plan 9, an operating system named after the science-fiction cult movie *Plan 9 From Outer Space*.

Plan 9 takes advantage of three basic technical ideas: all the system objects present themselves as named files that are manipulated by read/write operations; all these files may exist either locally or remotely and respond to a standard protocol; the file system name space (set of objects visible to a program) is dynamically and individually adjustable for each of the programs running on a particular machine. While the first two ideas have been foreshadowed in UNIX, the third is new.

Although developed by the group that developed UNIX, C and C++ (including Dennis Richie and Ken Thompson who developed UNIX in 1969), Plan 9 is not a replacement for UNIX. It is a new design.

Plan 9 runs on the Intel 386/486/Pentium, MIPS and SPARC and Motorola 68020 platforms. It also supports symmetric multiprocessing.

Plan 9 (entire source code; two volume manual) is available on CD-ROM for \$350. Also included are four PC disks containing a binary-only version for demonstrations. For more information call (800) 462-8146 (in the United States) and (415) 943-4076 (outside the United States) On the WWW, use the URL <http://plan9.att.com/index.html/> ●

Progress — important aspects of human interactions are relentlessly devalued."

In spite of Stoll's meandering, stream-of-consciousness style (a free-form meditation as Stoll calls it) he does have the right idea. As he says, "Access to a universe of information cannot solve our problems: we will forever struggle to understand one another. The most important interactions in life happen between people, not between computers."

## The Trouble With Computers: Usefulness, Usability, and Productivity

by Thomas K. Landauer  
1995; The MIT Press,  
Cambridge, Mass. 429 pp.  
ISBN 0-262-121186-7  
\$27.00

In *The Trouble With Computers*, Thomas Landauer, former director of Cognitive Science Research at Bellcore (the research arm of Bell Laboratories) and now professor of psychology at the University of Colorado, takes up the cause of User Centered Design, Development and Deployment (UCD). In the process he presents a rather bleak picture of computerization in the '90s. In the first several chapters, by looking at the history of productivity (or lack thereof) in the United States and other countries, by examining econometric analyses and the phenomena known as the "Com-

puter Productivity Paradox" Landauer amasses what seems to be most, if not all, the available evidence for his argument — that despite all the hype and for all their capabilities, computers have not made us any more productive.

However, in the second part of his book, Landauer finally gets down to discussing why the productivity paradox is wrong, as well as debunking other arguments often uttered in defense of the computer by technocrats. Most of the arguments, (which Landauer calls "excuses") are based on the so-called "undeniable facts" of computer power, the popularity of computer technology and the enthusiastic arguments of evangelical computerphiles. The result? There is really more wrong with computers than we like to admit. But that's not as bad as it sounds, according to Landauer. Computers have potential, but only if we apply the concepts of UCD.

With footnotes and references, the book is academic in its format and unfortunately, in style and tone as well. That makes it rather difficult to read and follow for long stretches. In fact, the MIT book editors would have been well-served if they applied some of the UCD principles to the presentation and layout of this book.

Uninformative and unimaginative subheads with very few graphics don't do much for a book that's dense with text. So, it's not easy to skim or surf for the interesting and thought-provoking insights that can be found in its 429 pages.

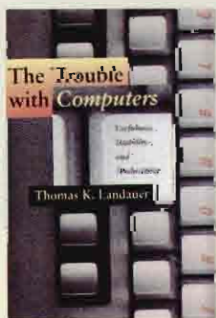

## NOTABLE QUOTABLES

"I have a very healthy respect for IBM.  
They're back."

— Lew Platt, HP CEO at Interex Press  
Luncheon in Toronto, Ontario.



If your company's survival depends  
on system availability,  
the HP 3000 is the one to rely on.

What computer system do you have?

---

The HP 3000 delivers 99.9% uptime. In fact, the  
latest Datapro User Survey of midrange systems  
ranked the HP 3000 #1 in system reliability  
ahead of IBM, Tandem and everybody else.

If the business decisions are yours,  
the computer system should be ours.



Computer Systems

# Close Encounters Of The Unkind

I just read your editorial page in the July 1995 issue and who says you need to approve of how David Packard, Gordon Moore, Paul Allen and Mitch Kapor spend their money?

These men worked hard to make their respective fortunes and how they choose to spend them is their business, *not* yours. Since when does the charitable inclinations of business leaders have a relevant relationship to the world of HP computing platforms.

I read your publication to get information and opinions of computing issues, not your opinions of others philanthropy.

*Terry W. Simpkins  
Director IS/IT*

*Lucas Control Systems Products*

I for one am glad that several industrial leaders are contributing to SETI. Answering the call of the human spirit to explore the undiscovered will do more for humanity than giving the money to welfare. This same spirit of adventure and curiosity is also no doubt partly responsible for leading them to the positions they hold today in the industry.

*Mel Bartels*

*Programmer/Technical Analyst  
Willamette Industries*

## ABRACADABRA ADDITIONS

I read with interest Jim Esch's article "The Magic of Network Printing" in the [July 1995 issue]. We are always looking for better ways to print from our UNIX, OpenVMS and NetWare systems.

I was disappointed that the article overlooked two successful network printing products — the NetQue/NetJet devices from Emulex, and the EPS terminal server line from LANtronix.

The Emulex and LANtronix products both provide multiprotocol printing from TCP/IP, LAT, AppleTalk and NetWare systems.

*Robert Aldridge*

*Senior Systems Programmer  
Babcock & Wilcox Co.*

## OPTICAL OOPS

Thank you for mentioning Automated Network Technologies as a supplier of hierarchical storage management software in your June 1995 article entitled "Optical Conclusions." Unfortunately, the phone number listed is wrong. Our correct phone number is (303) 789-2506.

*Hal Abbott  
Founder*

*Automated Network Technologies*

## EDITOR'S NOTE:

The Product Watch article in June 1995 issue of *HP Professional* titled "Break The Memory Block" reports PNY's competition Kingston Memory entered the workstation memory market last year. Kingston Memory has been making memory in the HP market since 1990. Kingston is located at 17600 Newhope St., Fountain Valley, CA 92708; (714) 435-2667.

*HP Professional welcomes comments from its readers. Letters may be edited for brevity and clarity, and should be addressed to HP Professional, 1300 Virginia Dr., Ste. 400, Fort Washington, PA 19034. Fax number:(215) 643-4827. Internet address for editors:*

*USERNAME@BOX101.CARDNAL.COM*

*Usernames are as follows:*

*Charlie Simpson - simpsoncm,*

*George A. Thompson - thompsonga*

*Deborah Schwartz - schwartzdr*

*Please include a phone number for verification.*



HP 9000 Memory

# PNY LOADS HP WORKSTATION MEMORY WITH THE WORKS:

**Quality, Pricing, Selection, Compatibility,  
Support and Service.**

PNY is committed to quality. That's why PNY manufactures every memory module in-house to ISO 9001 standards. When it comes to your bottom line, PNY prices are among the lowest in the industry. Searching for selection? PNY's product availability is second to none. That's because PNY is the world's largest producer of standard memory modules. If you're concerned about compatibility, relax. PNY also creates flawless customized configurations. In case you didn't know, the art of technical support is alive and well at PNY. Simply dial 1-800-234-4597 to speak to a trained PNY tech support rep or to access the PNY Fax-Back Service for instant product information. Add to this a full lifetime warranty, 24 hour delivery and you'll see why PNY wrote the book on service. So, if you're going to buy more memory for your HP workstation, shouldn't you get it with the **works**?

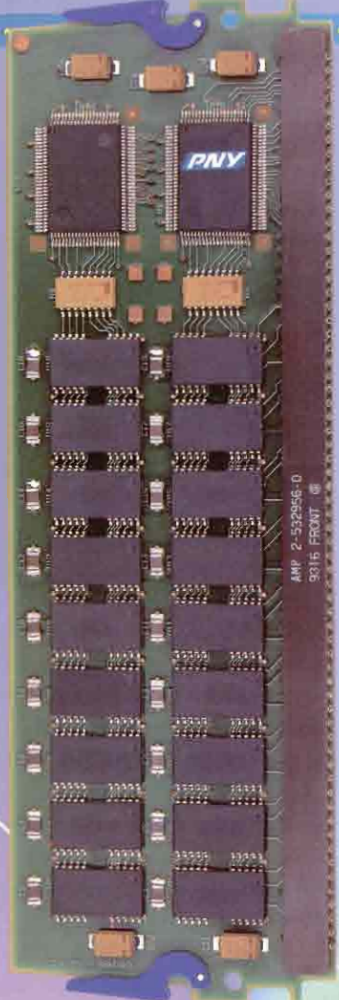

SUN X132M

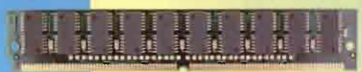

DEC MS15-FA

## HEWLETT PACKARD WORKSTATIONS

Workstation Model	Upgrade
HP 9000 700/RX stations, ENVIZEX, ENTRIA	2MB, 4MB, 8MB, 16MB, 32MB
HP 9000 700 Series	8MB, 16MB, 32MB, 64MB, 128MB
HP 9000 8X7, F, G, H, I, Series	16MB, 32MB, 64MB, 128MB
HP 9000 J, K, Series	32MB, 128MB
HP 3000 9X7 Series	16MB, 32MB, 64MB, 128MB
<i>And many more...</i>	



To find out more about PNY workstation products,  
call **1-800-769-0142**



**Corporate Headquarters:** PNY Electronics, Inc., 200 Anderson Avenue, Moonachie, NJ 07074, Tel. 201-438-6300, Tech Support 800-234-4597

**Western Regional Headquarters:** 1 Venture, Suite 240, Irvine, CA 92718, Tel. 714-727-3610

**Midwest Regional Headquarters:** 1162 Penarth Court, Commerce, MI 48382, Tel. 810-360-2750

**Southern Regional Headquarters:** 18047 Whispering Gables, Dallas, TX 75287, Tel. 214-407-0370

**European Headquarters:** Rue J. Cugnot, Zac du Phare-bp 181, 33708 Merignac Cedex, France, Tel. 011 33-56-13-7575

**Munich Sales Office:** Dianastr. 20, 85540 Haar, Germany, Tel. 011 49-89-460-5914

# Backup To Basics With Palindrome



## BACKUP DIRECTOR 4.0

- Supports NetWare Directory Service, Storage Management Services and the industry standard ECMA-208, SIFD tape format
- Scalable performance of up to 700 MB per minute
- Price is \$349 for single-server networks of up to 25 users

### Palindrome Corp.

600 E. Diehl Rd.  
Naperville, IL 60563  
tel: (708) 505-3300  
fax: (708) 505-7917

CIRCLE 354 ON READER CARD

**A** good backup software product can mean the difference between status quo and snafu. For network administrators, IS managers, system integrators and network consultants who are upgrading networks to Novel NetWare 4.1, Palindrome Corp. (Naperville, Ill.) offers Backup Director 4.0 which provides everything you need to protect your NetWare software, applications and data.

Eric Ferguson, LAN engineer at Maryland Insurance Group (Baltimore, Md.), a commercial insurance company that is part of Zurich, Switzerland-based Zurich Insurance, started using Palindrome's backup solution six years ago. Ferguson is running Backup Director 4.0 on a Compaq ProSignia 300 with dual DLT drives. Data, such as actuarial spreadsheets, legal cita-

tions, custom-written tax management applications and various Lotus groupware application information, is backed up to a Novell server. Currently, users are backing up their own Windows NT systems. Ferguson hopes to install Palindrome's Windows NT backup software to standardize backup throughout the company.

Backup Director features native NetWare Directory Service (NDS) support. It also supports Novell's Storage Management Services (SMS) and the industry standard ECMA-208/SIFD tape format. It also has scalable performance of up to 700 MB per minute.

Other features include: an Environment Checker; cue cards which walk users through the steps involved in critical day-to-day processes; and a system message database which identifies problems and provides recommended actions for troubleshooting and problem resolution. According to Ferguson, despite frustration with the command-line utilities, Backup Director has been easy to deploy. "If they were at all familiar with a DOS utility directory, we were able to push this to another end-user," Ferguson says. "Retrieval through the basic front-end was easy, even for non-technical users."

With the Windows Control Console interface, you have a

single point of administration to proactively monitor, manage and report on all operations and complete tasks with a mouse click. Palindrome File Manager lets users restore their files ensuring that network security is maintained.

SafeStore Technology prevents, detects and automatically recovers from system, user, hardware or media failure. A recover disk manages entire server recover process and eliminates the need to completely reinstall NetWare or Backup Director in order to recover a server.

Palettes provide access to critical information from anywhere within the program and notification of critical events for immediate action. SNMP Alerting gives notification of backup conditions to all SNMP-enabled network management consoles. And a high-availability backup reassigns backup jobs to another device upon hardware failure.

Backup Director 4.0 is available for \$349 for single-server networks of up to 25 users. A single-server with unlimited user support is \$995 and the multiserver unlimited version cost \$1,595. Upgrade prices for registered users start at \$295 for the multiserver version.

—Deborah Schwartz,  
Assistant Editor

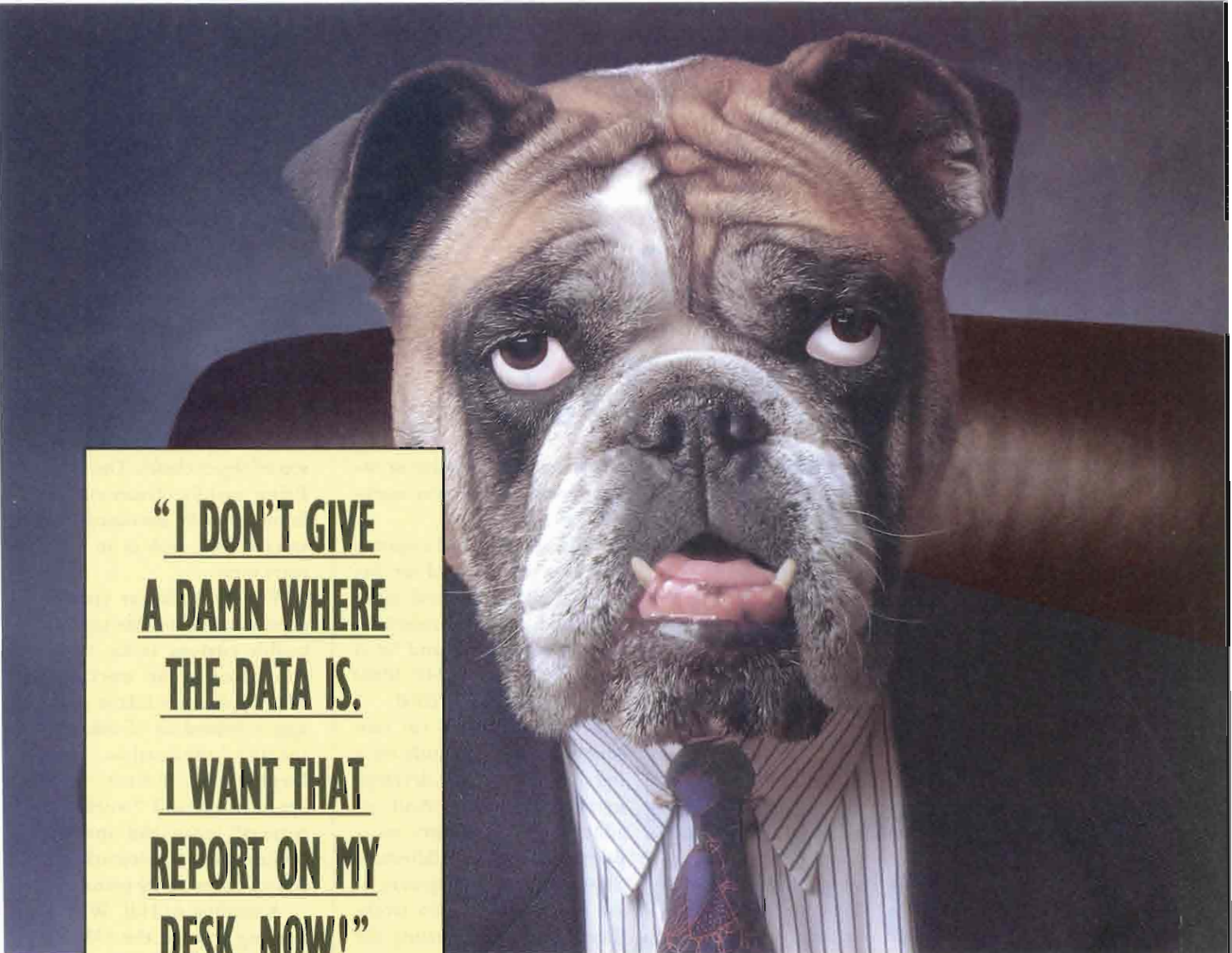

**“I DON'T GIVE  
A DAMN WHERE  
THE DATA IS.  
I WANT THAT  
REPORT ON MY  
DESK, NOW!”**

When the boss needs a report, the last thing he wants to hear is a speech on incompatible platforms, tools and databases. That's why thousands of the world's leading corporations have standardized on FOCUS for accurate, consistent reports from any database on any operating system.

#### **PORTABLE, SCALABLE AND CONSISTENT**

FOCUS reports and applications are portable and scalable to more than 35 operating systems...from PC to midrange to mainframe. You can design an application in FOCUS Reporter for Windows and run it in FOCUS Reporter for Motif, Open VMS, MPE, MVS...you name it. This means your VP of Finance can get the exact same report from his mainframe as the VP of Marketing gets from his PC LAN or UNIX system. And FOCUS provides a complete development toolset. So it's easy to create a simple query or a comprehensive GUI reporting application.

#### **ANY DATABASE, ANY PLATFORM, ANY PROTOCOL**

FOCUS Reporter offers direct interfaces to all popular server databases. And with our advanced middleware technology, you can access and join files located in virtually any database (relational or legacy), using your choice of communications protocols. No other reporting tool offers an easier migration path through any change in your information architecture.

#### **MORE POWERFUL THAN SQL TOOLS**

When SQL report writers and relational tools run out of steam, FOCUS Reporter makes it simple to create even the most challenging reports with multiple subtotals in year-to-year comparisons, rankings, "what if" scenarios, one-pass "if then" calculations, conditional fields, and more. And unlike other reporting tools, the English-like FOCUS language gives you an easy audit trail to any summary number, so there's never a question about how it was calculated.

#### **FREE DEMO DISK**

For more information and a FREE demo disk, contact your local Information Builders Sales Office or call 1-800-969-INFO.

**CALL 800-969-INFO**

In Canada Call 416-364-2760

 **FOCUS**

**Information  
Builders**

FOCUS and EDA/SQL are trademarks of Information Builders, Inc., 1250 Broadway, NY, NY 10001.  
All other trademarks are the property of their respective owners.

**CIRCLE 247 ON READER CARD**

# Template Software's WFT Moves Data

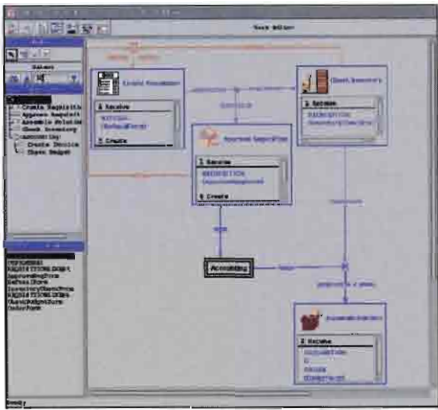

## WORKFLOW TEMPLATE 3.0

- > No restrictions on work items
- > Allows parallel development of the various aspects of a workflow system
- > Supports TCP/IP, UNIX mail protocols and any user-defined protocol

### Template Software Inc.

13100 Worldgate Dr.  
Ste. 340  
Herndon, VA 22070  
tel: (703) 318-1000  
fax: (703) 318-7378

CIRCLE 353 ON READER CARD

**B**uying a new house? Then you know it's a far from simple process. According to Paul Hill, president of Open Systems Associates Inc. (Reston, Va.), the real estate industry doesn't have a standard process model. "It's hard to figure out how to get from 'Gee, that's a nice looking house' to moving in." He determined that in order to create a standard for this industry, two criteria must be met. "First, you must define the process. Then, you must institutionalize this process into programming that allows the various players to be coached through the process."

Hill chose Template Software's (Herndon, Va.) Workflow Template 3.0 (WFT), a fully integrated object-oriented development environment and visual tool for organizing com-

plex flows of information in enterprise-wide production workflow systems.

Hill uses SNAP, Template's OO development tool for distributed, mission-critical applications. It's WFT's underlying development tool, and he is running it on an HP 9000 Series 700 and an RS/6000.

Hill chose WFT for two reasons: WFT is built on a rich, template-based development architecture. And, its adherence to industry standards. The WFT architecture allows parallel development of the various aspects of a workflow system by separating the activities of workflow design, task development and workflow management. There are no restrictions on work items: forms, compound documents, text files, images, voice messages and video are all handled.

WFT's integrated development environment includes seven editors. Workflow Design Editor provides an interactive graphic layout. Using a graphic representation, the Workflow Simulator allows the designer to simulate a workflow to identify bottlenecks or other design problems prior to deployment.

The Class Definition Editor specializes the WFT predefined classes to model the business objects. The Schema Editor is used to define work items as

sets of object classes. The Form Editor rapidly creates custom forms generally associated with specific tasks, such as an order entry form.

The Task Editor visually depicts and defines the tasks, or builds custom tasks, to be automated in the workflow. The Application Editor packages a defined set of tasks as a specific application. The Deployment Editor maps applications and "workflow servers" onto the specific processors in a network and defines connectivity protocols.

According to Hill, WFT is moving toward the OMG's CORBA standard. "We don't consider C++ to be object-oriented," Hill says. WFT supports TCP/IP, UNIX mail protocols and any user-defined protocol through its generic interface. It integrates with multiple relational databases (Oracle, Sybase, Informix, Interbase and DB2). WFT's encapsulation capabilities allow for integration with any legacy system, document management or image solutions. WFT supports task processing of any type or complexity, real-time system management and control, as well as flexible, reliable and efficient routing and distribution.

—Deborah Schwartz,  
Assistant Editor

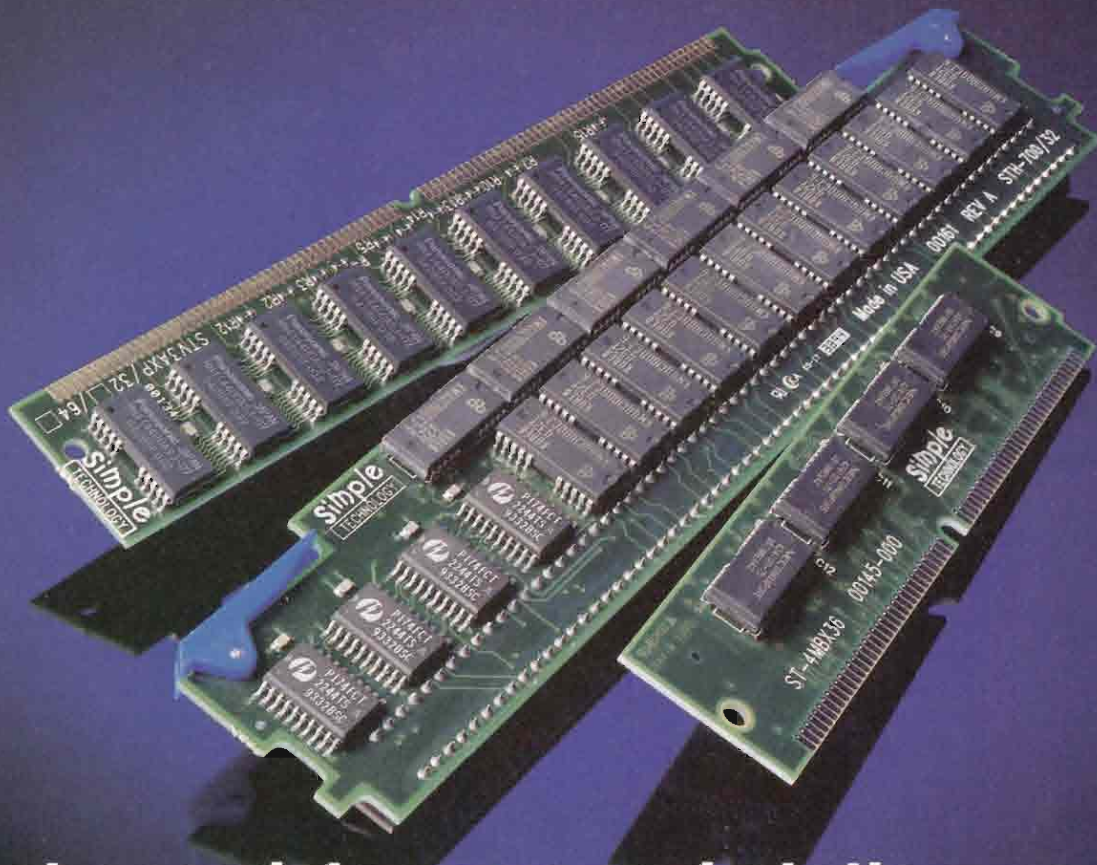

# What goes into your workstation memory is as important as what goes into your workstation.

A workstation is no place for unproven components. Especially memory upgrades.

So, make sure yours is from Simple Technology. Because no one puts more into workstation memory than we do.

## Uncompromising Engineering

High-performance workstations require high-performance memory. And ours performs like a thoroughbred.

Every Simple Technology memory product is designed to meet or exceed your workstation's requirements.

Individual system-level testing in actual workstation guarantees 100% compatibility.

And strict quality control in our manufacturing facilities results in memory products that really last a lifetime.

Simple Technology also keeps your workstation on the leading edge with new advances like our revolutionary IC Tower™ chip stacking technology.

## Wide Product Selection

Whatever your workstation, we've got the memory. In standard configurations up to 256MBs.

Best of all, we're committed to maintaining in-stock inventory, so the products you want are often shipped the same day.



## Service, Support, Satisfaction

Feel good knowing your memory is made by the world's fastest growing memory manufacturer.

We offer free and unlimited technical support, a product evaluation program that can put any of our 1000+ products in your hands instantly, and a proven track record for consistently being first to market with new workstation memory.

## Call For Your Free Catalog

Call 800-4-SIMPLE today to receive your free Simple Technology Workstation Memory Upgrade Catalog. Or call to find a dealer or reseller near you.

Put the reliability and power of Simple Technology memory in your workstation.



**800-4-SIMPLE**  
800-474-6753



Memory and PCMCIA Solutions™  
CIRCLE 261 ON READER CARD

For instant information contact our faxback at **800-429-5626 x500**

# Ready For Prime Time

## Hermes SoftLab Reaches Out Over The Alps For Customers



"There is a great resource of people in East Europe, but there is a lacking in software engineering providers."

**Rudi Bric**  
General Manager  
Hermes SoftLab

### Hermes SoftLab

Celovska 73  
61000 Ljubljana  
Slovenia  
tel: 386 61 1405 004  
fax: 386 61 1405 070

CIRCLE 352 ON READER CARD

In 1991 Slovenia declared its independence from communism. For Hermes SoftLab this was not only a political victory, but it allowed the small software development company the opportunity to expand and produce like they had envisioned for over a year.

Today it is a different story and Hermes co-founder and general manager, Rudi Bric, attributes the company's success to a "manageable growth" strategy. "Each of our projects is self contained with all aspects of business," he explains.

Hermes started software development in 1988 with four engineers. At that time the engineers were part of the Software Support team in Hermes, the exclusive representative of HP in former Yugoslavia. In 1990, an independent Hermes SoftLab was formed as a privately owned company.

Product lines included network spooling and backup, large scale client-server applications, messaging systems, transaction processing, GUIs, RDBMSs, LAN and WAN programming, and OpenView platform integrations. Hermes products run on HP-UX, SunOS, AIX, Windows NT, Xenix and Digital UNIX.

Along with product development, Hermes began to deliver consulting services, technical support and educa-

tion for UNIX operating systems, C language, networking and relational databases. Today, Hermes dedicates its efforts on the services end of the business.

In addition to expanding his company, Bric who is also the director of the Slovenia National Handball team, is spearheading a change of attitude. He has made it his mission, along with other businesses in Slovenia, to advertise that, today Slovenia is developed, productive and can be profitable. However, foreign companies interested in Slovenia's young talent pool should not view the country as a cheap source of labor. "You can give a starving man a piece a bread and he may work for you for a short time, but this is not a real solution," warns Bric.

Located in the capital of Slovenia, Ljubljana, Hermes employs people from nine countries within the region including refugee developers from Bosnia and Croatia. The average age of Hermes' programmers and developers is 24, and most are recruited from the local universities. "There is a great resource of people in East Europe, but there is a lacking in software engineering providers," maintains Bric. This lack has created a natural growth path for the small software developing company.

According to Bric, "The state provides no money. The government said, 'It is now a free market country. You make it work.'" And Hermes has. In fact, despite the current government's "hands-off" policy regarding industry and deregulation, Hermes has grown from four to over 80 employees and plans to reach 100 by the end of the year.

In 1993, Bric received the "European Small Business Person of the Year Award" in Dublin, Ireland. Hermes has a representative in Germany, along with a joint-venture firm in Lithuania. The firm has also prominently exhibited at U.S. trade shows as well as international European shows. HP itself is among Hermes largest customers, including HP's Analytical, Medical and Network Systems Management divisions.

Bric estimates Hermes revenues will reach \$5 million with about 80 percent of business coming from abroad. When asked about partners or representatives in the United States Bric says, "the trust level of U.S. companies in non-U.S. companies to produce software is not very high. Especially from Eastern Europe. But we're working to change that"

*Charlie Simpson,  
Editor-in-Chief*

# When Your Data's Under Siege, You're Protected.

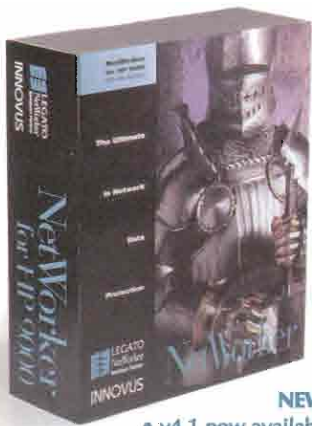

## NEW!

- v4.1 now available
- Archive/retrieve module
- HP OpenView integration
- HP-UX 10.x support

In the battle for the desktop, don't leave your data unguarded.

The explosion of user data has created a data storage management task of enormous magnitude. You need client/server software designed for the realities of today's distributed computing environments. You need **NetWorker for HP 9000**.

NetWorker efficiently and effectively counters all threats to your data. Backup and archival services for the entire organization are centralized on the HP 9000 server. The storage management requirements of an entire multi-vendor network can be met using this enterprise-wide solution.

More Unix desktops and servers are protected by NetWorker software than by any other solution. Combine that with NetWorker's proven protection for NetWare, OS/2, DOS/Windows, and Windows NT, and the battle to defend your data is won.

NetWorker's legendary protection. Available for HP-UX from INNOVUS.

For more information on NetWorker for HP 9000, contact an authorized reseller, or INNOVUS:

Tel: (905) 529-8117; Fax: (905) 572-9586

E-Mail: [inforwr@innovus.com](mailto:inforwr@innovus.com)

URL: <http://www.innovus.com>

A large, detailed illustration of a knight in full plate armor, including a helmet with a visor. The knight is holding a computer monitor in his right hand and a keyboard in his left hand. The monitor has the HP logo and 'HEWLETT-PACKARD' text on the bezel. The background is a dark, moody sky with a hint of a sunset or sunrise. The overall theme is 'data protection' and 'defense'.

## NetWorker<sup>®</sup>

for HP 9000

### The Ultimate in Network Data Protection

Legato NetWorker is a registered trademark of Legato Systems, Inc. All other trademarks are the property of their respective owners.

INNOVUS Technologies Inc.



CIRCLE 167 ON READER CARD

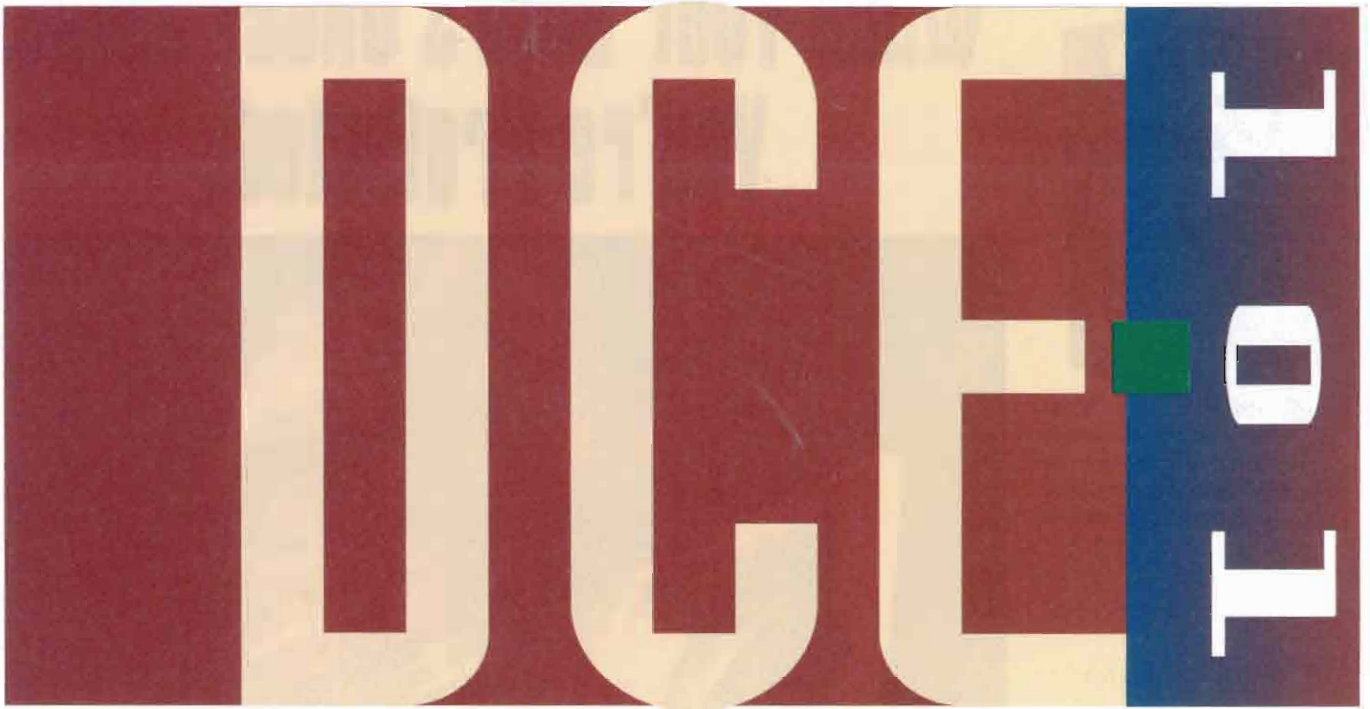

## The Distributed Computing Environment (DCE)

is opening a new computing age. The more

Hardware. Software. And networking. They are the foundation for any client-server distributed application. Usually, the software pieces execute on two or more systems, which often means different hardware and different operating systems. As you can imagine, that's difficult to accomplish without a standards-based framework. Because you can obtain Distributed Computing Environment (DCE) components from a variety of different manufacturers, DCE, may very well be the best framework on which to build your applications.

### DCE'S COMPONENTS

GAINING A DEEPER understanding of the DCE components is the first step to determining whether or not DCE is right for your computing environment.

**heterogeneous your  
environment, the more  
DCE will help you. This  
primer explains the  
fundamentals of DCE.**

### DCE REMOTE PROCEDURE CALL (RPC)

DCE RPC models two distributed processes as a subroutine and a caller of the subroutine. You can imagine a client-server program in which the client calls a subroutine on the server. Data is passed back and forth between the client and the server using the DCE RPC. The client and server can now communicate, they can locate one another on the network, and data that is sent across the network is converted into the appropriate format. This is the highest level of integration.

One of the reasons so many developers are interested in working with the DCE RPC is that it does not depend on any particular protocol or network type in order to work. This means that a server which must communicate with a variety of different clients on different types of networks can do so with the DCE RPC. In many cases

Marty Poniatowski



# Western Scientific's Superior Disc Storage is no Fish Story.

We thought you'd want the best. That's why we use Seagate *Barracuda* discs in our "highest performance, smallest form-factor" UNIX storage subsystems.

Using *Barracuda* 7200 rpm 3.5-inch drive technology, we build disc storage and RAID subsystems with up to 4.3 Gbytes per spindle and transfer rates up to an incredible 14.0 Mbytes/sec per drive.

While our competitors will ask you to settle for whatever they hooked on the line, we remain true to technology. True to performance. True to our promise of quality.

Insist on premium peripheral products with superior service and support from Western Scientific... not just any catch of the day.



keep the big one, throw the little ones back.



to upgrade your UNIX workstation, call: **1-800-443-6699**

4631 Viewridge Avenue, San Diego, California 92123 • USA  
Tel: 619-565-6699 Fax: 619-565-6938  
Email: [info@wsm.com](mailto:info@wsm.com) WWW: <http://www.wsm.com>

Seagate and the Seagate logo are registered trademarks of Seagate Technology, Inc. Barracuda is a registered trademark of Seagate Technology, Inc.

CIRCLE 194 ON READER CARD

there are clients already in place, such as PCs and workstations, to which a server must communicate. With the DCE RPC there are minimal restrictions on the protocol and network type so many different clients can be used. The DCE RPC is tightly integrated with naming and security services that also are part of DCE.

## DCE DIRECTORY SERVICES

WITH MANY systems on a network it is important to be able to allow clients to locate servers. Using two components, the Global Directory Service (GDS) and Cell Directory Service (CDS), a hierarchy is produced in which the names and attributes of systems are supplied throughout the network. A local set of nodes is called a cell. A CDS appears as a branch in the bigger GDS tree.

The directory service uses a hierarchical name-space much like many operating systems use a hierarchical filesystem. There is a root directory and a number of sub-directories. Within each leaf directory you can have any number of entries. The entries contain information about the servers in the cell.

## DCE SECURITY SERVICE

THE DCE security server provides many user services including the following:

- User authentication — Is a user on the network who they claim to be?
- User authorization — What is the level of security privilege for this user?
- User access control — Can the user perform the operation they want to perform?
- User privacy — Does the data need to be protected from unauthorized viewing?

The DCE authentication server is used to provide these security functions. Passwords are used when a user logs on a system. Password validation results in a user being granted a "ticket." This ticket is the user's identification that is used by the

## Out Of The Muddle And Into The Middle

David Baum

When it comes to internetworking, most companies are well on their way to combining HP 9000s, HP 3000s and PCs in an interoperable infrastructure.

Now for the tricky part: how do you establish application-to-application communications that can accommodate

the different operating systems, databases and networking protocols involved?

Would you believe the answer is middleware? To most end users, middleware is a nebulous, mystical layer of software that sits between the application and the operating system. To software developers, middleware helps sort out a wide diversity of protocols, platforms, databases and programming languages, so they can spend more time focusing on what they do best — building applications. How can anyone argue with that?

Middleware offers a common method of exchanging interapplication messages between the numerous pieces of a distributed application. This allows developers to concentrate on the problem that the application is addressing, rather than getting bogged down with the programming details of a particular database or communications technology, according to Judith Hurwitz, president of the Hurwitz Consulting Group (Watertown, Mass.).

### TYPES OF MIDDLEWARE

MIDDLEWARE solutions available in the market now include:

- Network gateways, such as EDA/SQL from Information Builders Inc. and Sybase Inc.'s Enterprise CONNECT.
- Message-Oriented Middleware (MOM) systems, such as Suite Software's SuiteDOME, the PIPES Platform from Peer Logic Inc. and DEC's DECmessageQ.
- Remote procedure calls (RPCs), such as HP's Broadcast Message Service (BMS), NetWise Corp.'s TransAccess and Micro Focus Inc.'s Application-to-Application Interface (AAI).
- Object Request Brokers (ORBs), such as HP's Distributed Object Management Facility (DOMF), IBM's Distributed System Object Model (DSOM) and Expertsoft Corp.'s XShell.

All kinds of middleware share a common goal: to provide seamless access to programs and data, regardless of hardware platform, operating system or database type.

United Artists Theatre Circuit Inc., the largest owner of movie theaters in the United States, is using middleware to simplify development and maintenance of new executive information systems (EIS). "GUIs foster a push-button mentality," says Carol Gompert, director of software development at the company's Englewood, Colo. headquarters. "Knowledge workers don't want to be troubled with obscure syntax and confusing commands."

To provide PC users with easy access to HP ALLBASE data residing on a network of HP 9000 and HP 3000 systems, United Artists is using FOCUS, an application development environment and EDA/SQL, a middleware gateway from Information Builders Inc. (IBI; New York, N.Y.). FOCUS is being used to create EIS screens, report procedures and application logic. EDA/SQL, on the other hand, handles data manipulation functions and data format translation between the HP databases and a variety of PC databases.

These new EIS applications will allow executives (by pressing a button on their EIS screens) to quickly obtain summary data, such as comparative profit and loss statements by district, "Middleware is the software that makes it go, allowing for efficient batch processing on the server. Once that button is

*continued on page 26*

# Supported **FAST**

The most powerful scientific  
visualization tool available.

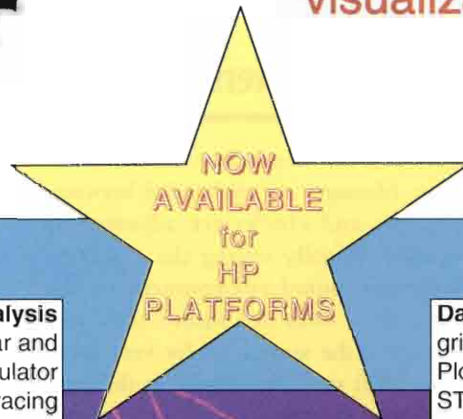

### Analysis

Fluid Dynamics scalar and vector functions, custom calculator formulas, isosurfaces, particle tracing

### Data Types

grid, solution, scalar, vector, ARCGraph, Plot3D, structured and unstructured, STAR-CD, Fluent, Rampant

### Object Attributes

mirroring, transparency, interactive lighting

### Rendering

points, lines, vectors, deformation surfaces, shaded/mapped surfaces

### Animation

keyframe, non-linear spline interpolation, stereo recording

### Object Types

titles, traces, rakes, ribbons, surfaces, cutting planes, contour surfaces

### View/Scene Control

3D transformation modes, spaceball controller, scene construction, sweeping, scripting

### Colormaps

Function, spectrum, contour, banded, striped, twotone, dynamic contours, shading

This year's Winner of NASA's  
Software of the Year Award!

Sterling Software • 303 Twin Dolphin Drive, Suite 510 • Redwood City, CA 94065  
Phone: 800/866-2492 • Fax: 415/802-7162 • e-mail: fast\_support@sterling.com



CIRCLE 153 ON READER CARD

DCE privilege server to determine a user's resource access during a log-in session. Kerberos is provided for user authentication. There are Access Control Lists (ACL) used for authorization and a registry that makes it easy for the system administrator to manage DCE users and their attributes.

A DCE server also can be replicated. Should the primary security server be down for any reason, the secondary, or replicated security server, can take over security operations.

## DCE DISTRIBUTED TIME SERVICE

The DCE Distributed Time Service insures clocks on computers on the

## In the Distributed Time Service, clerks obtain time intervals from several servers.

network are kept close to the same time. Messages are exchanged between systems and clocks are adjusted as needed. Initially setting the clocks in your distributed environment to the same time does not insure they will remain at the same time for very long. The "drift rate" for clocks on different systems will vary and you can be sure

over time these will not remain the same. The DCE Distributed Time Service is itself a client-server application. Each DCE cell has one or more Distributed Time Service servers that provide information to clients and applications through intermediaries called clerks. The clerks and Distributed Time Service servers work together to relieve applications of the overhead of insuring correct time.

Despite HP's atomic clock that keeps incredibly accurate time, it's just not possible on computers in a distributed environment. In the Distributed Time Service, clerks obtain time intervals from several servers and compute the intersection of these intervals. The midpoint of this interval

## Out Of The Muddle And Into The Middle

continued from page 24

pushed, a series of pre-set tasks are executed," Gompert explains. Rather than pulling down tens of thousands of records to the PC, EIS requests

can be shipped across the network gateway for execution on the server. The EDA/SQL middleware handles the cross-platform communications, including data manipulation and data format translation services, with only the answer set sent back to the PC.

This type of client-server processing leads to effective application partitioning, according to Hurwitz. Application partitioning lets each task be allocated to the best processor for the job, regardless of its type or location in the network. Middleware like EDA/SQL supplies developers with a common API to simplify development of these distributed applications, even when the processing involves different types of hardware platforms and databases over a WAN.

## MY MOM IS SMARTER THAN YOUR MOM

THE ABILITY TO put the right processing on the right processor also motivated Blue Cross and Blue Shield of Oregon to use PeerLogic Inc.'s (San Francisco, Calif.) PIPES Platform. PIPES is now serving as the communications infrastructure for the Blue Cross/Blue Shield Unified Member Services System (UMSS). UMSS enables more than 250 Blue Cross and Blue Shield member services representatives to transparently access customer data within a network consisting of Windows-based PCs and Sun Solaris SPARCstation servers linked with multiple IBM mainframes and HP 3000 systems.

Nathan Dolly, a senior programmer with the UMSS project, says Blue Cross and Blue Shield considered several options for its distributed computing needs, including RPCs

and ORBs. But they opted for the PIPES MOM system because of its fast, asynchronous messaging architecture and ease of installation. The selection process taught Dolly and his colleagues that each type of middleware has strengths and weaknesses. RPCs are typically coded into each application, resulting in superior performance. However, this means network addresses are compiled into the application code. If something changes on the network, programs must be modified and recompiled.

ORBs are gaining popularity as the Object Management Group solidifies the Common Object Request Broker Architecture (CORBA), which establishes standards among different ORB implementations. But working with ORBs requires knowledge of object-oriented development. And as Dolly points out, that's hardly a commodity in the open market at the present.

MOM systems, by contrast, can be used by traditional and OO programmers to determine network addresses at run time. If the network configuration changes, the programs don't need to be modified, as RPC-based systems require. Also, MOM systems provide a guarantee of delivery in the event of a network failure; lost messages are resubmitted automatically once the network comes back up. "Messaging systems aren't tied to a specific operating environment or networking protocol the way RPCs are," notes Ken Fleming, president of Suite Software Inc. (Anaheim, Calif.), a MOM vendor. "They can be both synchronous and asynchronous. And there is a certain degree of fault tolerance built into a messaging environment." Hurwitz agrees that there are pros and cons to each type of middleware. But all of them succeed in one important area — disguising the boundaries among differing networks, databases and operating systems.

Middleware is also playing an important role at TRW's

continued on page 28

# Imagine. If only you were able to Automatically, Remotely, and Completely, Shut Down and Start Up your UNIX Systems...

Does *Security*, *Savings*, and *Convenience* come to mind?

Introducing The ISA Intelligent Automatic Startup/Shutdown Unit

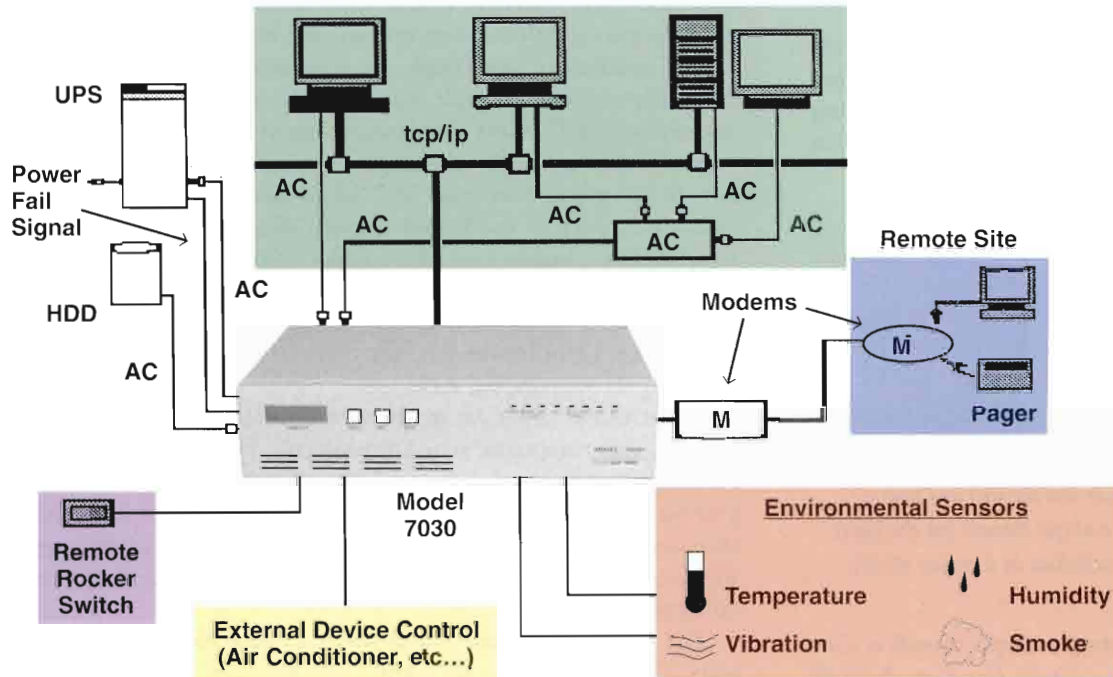

*Imagine No More!*

- The ISA Model 7030 was designed to simplify and automate the process of managing the AC power ON/OFF schedules of networked UNIX Workstations.
- It provides enhanced *security* since it secures the startup and shutdown procedure against unauthorized access. Plus, it's pretty hard to break into a system across the network when it's not on. Additionally, preset messages can be sent to a pager to warn of abnormal environmental conditions (earthquake, fire, flooding, etc...), and/or the system could be made to gracefully shutdown to preserve data integrity.
- The unit also provides *savings*. How? Well, your workstations use no energy when powered off. Therefore, there are savings on your utility bills as well as the earth's resources. Computer and peripheral life expectancy are also increased. Components last longer when powered on less, so you also save on equipment costs. And hey, the 7030 can save your valuable time too because you will spend less time recovering from unscheduled or 'ungraceful' shutdowns.
- Which brings up *convenience*. Non-technical users do not need to know shutdown or startup procedures. They can just flick the remote rocker switch off or on and go, or even let the programmable timer do the work. Technical users also benefit. They too can just 'flick and go'. No more shutting down (or starting up) systems one at a time. In fact, you could even remotely shutdown one or several workstations by using the 7030's built in modem port.
- Impressed? Then call us for more information on our unique line of UNIX Power Management Solutions. In fact, if you qualify, we will send an evaluation unit so that you can experience all the benefits of an extremely safe, and properly managed power control environment. And, who knows? This just might give your company a competitive edge. Now, imagine that!

CIRCLE 473 ON READER CARD

Texas **isa**, the name of Innovation  
Tel: 713-493-5746, 800-361-2258

is then used to set the system clocks. If a clock does not fall into the time interval obtained from other systems, it is assumed to be faulty and is not used in computing new times.

DCE THREADS

BASED ON standard POSIX interfaces, threads is a way of improving application performance by implementing parallelism. For those familiar with

FIGURE 1

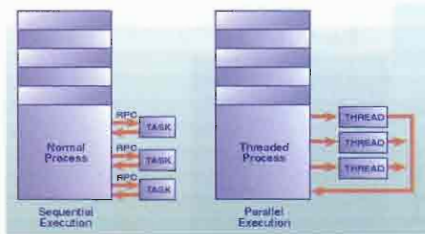

How a normal process executes serially without threads (on the left) and how a process with multiple threads (on the right) would use parallelism in a section of code.

UNIX, starting multiple threads is a lot like forking multiple processes. A lot of work can be done in parallel. This results in not just one flow of control, which is what we are accustomed to in the traditional programming model, but in multiple, simultaneous flows of control. (see Figure 1)

DCE DISTRIBUTED FILE SERVICE (DFS)

DISTRIBUTED FILE Service allows a program to access files on the file server just as if they were located on the local system's disk. This goes beyond using a network operating system (NOS) or Network File System (NFS), because with DFS every node in the network identifies the same file by the same name and sees it located in the same directory. DFS hides the physical layout of the network from the user and insures that people don't mount directories under different mount points.

When a client reads a file, a copy of that file is physically loaded from the server to the local client's cache. The

Out Of The Muddle And Into The Middle  
continued from page 26

Systems Integration Group (Fairfax, Va.) in the form of VeraFind, a proprietary solution designed by TRW to identify fingerprint images captured with electronic scanning equipment. Running primarily on HP 9000 computers, VeraFind reads fingerprint images directly from a person's finger or fingerprint cards, compresses them, and stores them in an image database on optical disks or RAID storage drives. TRW uses SuiteTalk, a MOM system from Suite Software Inc. to send structured messages among different networks and hardware architectures.

The middleware helps single-site installations of VeraFind share and exchange information among multiple workstations, explains Tom Markovitz, a software engineer at TRW. Some VeraFind customers have multiple platforms to contend with as well, such as the British Home Office in London, which uses HP 9000 systems in conjunction with Sun Solaris workstations. For large multiplatform installations, such as the British Home Office, TRW is planning to upgrade to SuiteDOME, a middleware which builds on the basic capabilities of SuiteTalk but adds multilayered security and a dynamic naming service. Clients and servers plug into the SuiteDOME message bus by announcing their presence and declaring their names. Once on the bus, any client can send messages to any server simply by calling the message bus API.

SuiteDOME relies on its own communications code to set up a session between two computers, initialize protocols, handle error recovery, and return a confirmation of message delivery." It gives us a means to communicate between processes, even when they are on different platforms," Markovitz says. "They allow us to send messages from servers to the engine that does image compression and decompression, to coordinate searches, and to perform data exchange among different databases."

The Suite middleware also provides an easy method of fail-over, Markovitz adds. "We don't have to write code to keep track of what messages are outstanding when a process dies," he says. "SuiteTalk can tell which messages are still in the queue and reinstate the system automatically after a system failure." TRW envisions applications for its VeraFind technology, primarily within the law enforcement industry, says David Clark, director of sales and marketing for TRW's Automated Identification Systems Division. — David Baum is a freelance business writer based in Santa Barbara, Calif. who writes about information technology. He can be reached at dwbaum@silcom.com.

Would you like to continue to see articles on this topic?

Circle on reader card  
yes 348 no 347

COMPANIES MENTIONED IN THIS ARTICLE

DEC  
146 Main St.  
Maynard, MA 01754  
(508) 493-5111  
CIRCLE 346 ON READER CARD

Expersoft Corp.  
6620 Mesa Ridge Rd.  
San Diego, CA 92121  
(619) 546-4100  
CIRCLE 345 ON READER CARD

IBM  
1133 Westchester Ave.  
White Plains, NY 10604  
(914) 642-3000  
CIRCLE 344 ON READER CARD

Information Builders Inc.  
1250 Broadway  
New York, NY 10001  
(212) 736-4433  
CIRCLE 343 ON READER CARD

Micro Focus Inc.  
2465 E. Bayshore Rd.  
Palo Alto, CA 94303  
(800) 872-6265  
CIRCLE 342 ON READER CARD

Netwise Inc.  
2477 55th St.  
Boulder, CO 80301  
(303) 442-8280  
CIRCLE 341 ON READER CARD

Peer Logic Corp.  
555 De Haro St.  
San Francisco, CA 94107  
(415) 626-4545  
CIRCLE 340 ON READER CARD

Suite Software Inc.  
801 East Katella Ave.  
Ste. 210  
Anaheim, CA 92805  
(714) 938-8850  
CIRCLE 339 ON READER CARD

Sybase Inc.  
6475 Christie Ave.  
Emeryville, CA 94068  
(510) 922-3500  
CIRCLE 338 ON READER CARD

## THE TOOLS OF DCE

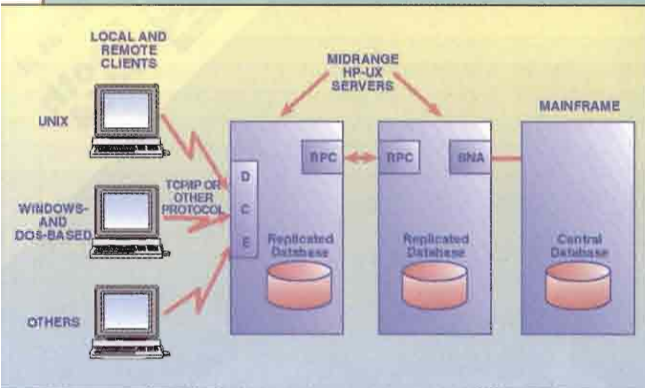

**Question:** How will the client interact with a server if you don't have control over the type of client? **Answer:** Because the DCE remote procedure call (RPC) has been implemented on a number of clients, it's a good solution for you.

For instance, you can use PC-DCE from Gradient Technologies Inc. which supports RPC, Directory Service (sometimes called Naming Service), Security Service, Time Service and Threads. This complex DCE functionality is made easier for application developers to implement on PCs with Visual-DCE also by Gradient. You can build a Microsoft Windows-based DCE application using Visual-DCE. There are other suppliers of DCE for clients which can help you when you find yourself supporting multiple clients in such an implementation.

At the midrange level, HP DCE/9000 provides the necessary links to the critical middle tier of this diagram. There are many criteria to consider when selecting the middle tier for such an application. The most important include: the performance of the systems; availability of necessary applications; scalability; and system and network management. One of the most critical factors is DCE functionality. You may find that this is the single most important factor when selecting the platform for the middle tier. All of the DCE functionality in this article, including the NFS-DFS Secure Gateway, are part of HP DCE/9000 which is based on the Open Software Foundation DCE services. HP also provides a variety of development tools for DCE application development. DCE for other platforms, such as PCs, are provided by many manufacturers including PC-DCE.

Part of the mainframe database is replicated on the midrange system shown. This can be for a number of reasons. The first is that the application architect may want to offload mainframe cycles onto the midrange system. This is a common goal because of the modest cost of midrange systems as they compare to upgrades to mainframes. The second is that the mainframe database may be used by a variety of other applications and the application architect wants to reduce the amount of locking of the central database that takes place. In any event, the midrange system has a replicated database on it which will need to be updated at some regular interval. This may be a long interval, such as once a day, if it is convenient to update after hours. It may be a short interval because of the importance of keeping the midrange and mainframe databases synchronized as often as possible.

If the midrange systems are used for inquiry only, then replication from the mainframe works well. There may, however, also be a need for simultaneous access to the midrange system and mainframe. A transaction monitor such as CICS/9000 or Encina for HP-UX may satisfy that need.

Embarking on a DCE project is a daunting task. So you may want to take a look at the various DCE program development tools available to make your job easier. One such tool, OODCE/9000 from HP, provides support for writing DCE applications in C++. There is a library of pre-defined C++ objects that encapsulate default DCE functionality. Instead of writing to the DCE API to define how an application should interact with DCE services, you can simply incorporate OODCE objects into the application. These pre-defined objects can be modified to meet your needs. At the same time, keep in mind that HP now bundles the DCE client into HP-UX 10.0. Taking a standards-based approach to your client-server development means you'll have the greatest level of support for your varied hardware platforms thereby avoiding a proprietary "lock in." — *Marty Poniatowski*

client copy is loaded to main memory or disk. Subsequent accesses to that file take place on the client and not the server, thereby reducing the overall amount of network traffic and server access.

## HP NFS-DFS SECURE GATEWAY (HP-SPECIFIC)

BY OFFERING the NFS-DFS Secure Gateway, which allows NFS clients that are not in the DCE cell to access DFS files without having to run DCE on the client workstation, HP has enhanced DCE.

In order for an NFS client that is not part of the DCE cell to access a DFS file, the user on the NFS client must obtain the proper credentials. When the user of the NFS client logs in using the NFS-DFS Secure Gateway product, these credentials are used to give the NFS client user access to the file. The drasd daemon running on the DFS client is used to obtain the credentials from the DCE Security Service. *Figure 2* shows this process.

**FIGURE 2**

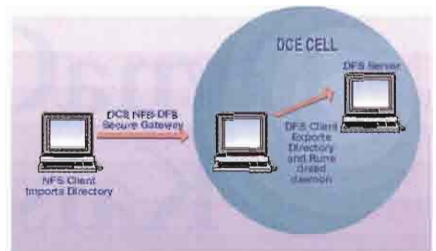

As DCE becomes more accepted, and because HP has bundled the DCE client into the HP-UX 10.0 operating system, you'll want to assess how it can be used to enhance your computing environment. — *Marty Poniatowski is a technical consultant in computer-aided engineering for Hewlett-Packard in Stamford, Conn. He is the author of "The HP-UX System Administrator's 'HOW TO' Book (ISBN 0-13-099821-4) published by Prentice Hall PTR and distributed by CBM Books, a division of Cardinal Business Media, Inc. For ordering information, contact CBM Books at (215) 643-8105*

Would you like to continue to see articles on this topic?  
Circle on reader card  
yes 350 no 349

**JOSEPH SLIVE**

*Senior Systems Analyst*

Kaiser Foundation Health Plan of Georgia, Inc.

NETWORLD INTEROP '95  
See us at  
**Booth #454**

*"Our 175,000 members depend on us every day for quality, cost effective healthcare. We depend on DynaComm's ease of use, flexibility and reliability."*

# DynaComm delivers for Kaiser Permanente

HMO giant Kaiser Permanente uses DynaComm as the cornerstone of their terminal emulation needs to access business-critical applications residing on UNIX and IBM hosts.

At FutureSoft, we know that PC connectivity has become a critical component in enterprise-wide computing. Our DynaComm product family provides extensive terminal emulation and network connectivity solutions for both asynchronous and IBM mainframe environments.

Take advantage of over a decade of experience, and discover what Kaiser Permanente, Digital, Hewlett-Packard, Thoroughbred and numerous Fortune 500 companies already know.

Call for a free DynaComm demo disk.

**1-800-989-8908**

Our latest version has all the features that serious computing environments demand:

- ◆ Optional support for Microsoft's Visual Basic
- ◆ User desktop tools which are easy to configure and support
- ◆ Selective, DLL-based installation on your PC or server to minimize application footprint
- ◆ Graphical tools including dialog editor and keyboard mapper for easy interface customization
- ◆ Scripting capability to call external DLLs which is unequalled in the industry

**DynaComm**  
by  **FutureSoft.**

*The Ultimate in Power and Flexibility*

CIRCLE 190 ON READER CARD



# HP's Channel Partners Program

What Is The Channel  
Partners Program? pg. 33

A VAR's View Of The  
Challenges And Changes pg. 35

Channel Partners Listings pg. 36

# Concorde Technologies

## Concorde Technologies' Network Backup Systems for the HP 9000

**T**he HP 9000 family of products are the fastest growing client/server platforms for use in large networks. The efficient backup of the large data bases in networks utilizing these products is critical.

Previously, the amount of data stored on a network was growing at 40+% per year. It is now

common to see annual growth rates of over 100%. As a result, the proper selection of available software and tape technologies is important. Primary technologies and their advantages to the HP 9000 user include:

- DAT
- Extends the value of your HP investment
- Supported by OmniBack
- Library configuration

- capacities to 480 GB DLT
- Excellent price/ performance
- Library configuration capacities to 10 TB 3480
- Supported by HP-UX
- Perfect for right-sizing applications 3490E
- Highest data transfer rates
- "Mini-Silo" capacities to 460 GB

Concorde Technologies provides the HP 9000 user with high speed data backup systems offering:

- Reliable, high speed systems compatible with the HP 9000
- The optimum combination of available hardware and software products

- Extensions to HP's OmniBack/DAT product family
- A wide range of tape technologies including DAT, DLT and 3480/90
- Support for a wide range of clients (e.g. Sun, DEC, IBM, SGI, PCs, Sequent, NCR, etc.)
- "Hot" backup for large databases including Oracle, Informix and Sybase
- Compatible technologies for data migration from mainframes (Right Sizing)
- Training, installation and maintenance programs.

## High-Speed Backup Systems for the HP 9000



### Now Available to Meet YOUR Application's Requirements

#### Concorde Technologies' Backup Systems Provide:

- 4 mm DAT, 8 mm, DLT, 9-track and 3480/90 drives and libraries
- Single and multiple drive configurations
- Backup/restore software
- Support for all major client/server platforms
- Hardware data compression
- Unattended backup to multiple tapes
- Hot backup of large databases
- Random or sequential access to stored data

- Removable magazine(s) for long-term archive and/or off site storage
- Automated backup, standardizing archive procedures

A variety of installation and maintenance programs are available. Please call Concorde Technologies at **1-800-359-0282** to discuss your network backup applications.

#### Concorde Technologies, Inc.

9770 Carroll Center Road, Suite F, San Diego, CA 92126  
(619) 536-5500, (800) 359-0282 Fax: (619) 566-4396  
Internet: sales@concordetech.com

# HP Channel Partners' Role In HP's Computer Strategy

**Hewlett-Packard Company** began as a partnership more than 50 years ago. Today the Channel Partners (CP) program of HP's Computer Systems Organization (CSO) Americas accounts for about 50 percent of the hardware sales for the group, which is responsible for marketing UNIX workstations, systems, servers and HP 3000 business computers.

Because of the size of its product lines HP has a mix of Channel Partners who are tightly coupled with HP to leverage sales opportunities. HP has established close marketing and sales links with U.S.-based and global Channel Partners. They have a strong international presence and sell or leverage millions of dollars worth of HP computers annually. CSO has more than 2,500 Channel Partners in the Americas and approximately 5,000 worldwide. They range in size and complexity from multibillion dollar international integration and consulting companies to small software developers with just a few employees.

## TWO-TIER DISTRIBUTION

AN IMPORTANT component of CSO's channel partners program is two-tier distribution. HP distributors buy products from HP and distribute them to resellers who deal directly with end-users. Distributors typically supply and support hundreds of resellers, called distributor authorized resellers (DARs). In the United States alone there are hundreds of companies with software solutions that leverage HP systems and workstation sales, and hundreds more that resell HP products along with their own value-added solutions.

These Channel Partners operate in a mix of HP value-added channels — VARs (value-added resellers), OEMs (original equipment manufacturers), ISVs (independent software vendors), DARs (distributor authorized resellers), SIs (system integrators), developers and other companies involved in providing computer solutions to end users.

HP's challenge is to direct an optimum mix of resources toward those Channel Partners who will leverage the greatest amount of HP business, as well as providing needed resources to smaller Channel Partners. To this end, HP seeks Channel Partners that bring real value to the relationship. They must provide an appli-

cation or integration solution for the HP platform, invest in training and marketing, and devote resources to making the relationship a success. For its part, HP has a wide range of marketing and technical support programs to benefit Channel Partners. For example CSO Americas reaches its customers through three separate, yet synergistic, selling organizations that complement indirect and direct selling efforts.

The company's account/industry sales force recently was established with an industry focus to serve customers in HP target markets. These include a group of large end users in manufacturing, financial services, telecommunications, distribution, healthcare, and federal, state and local governments.

A second sales team is organized in a more traditional fashion along geographic lines, devoted to reaching medium and small firms in the above industries and all end users in other industries.

The third prong in the sales strategy is the HP Channel Partners program in which HP works closely with CPs to reach customers with Channel Partner-developed solutions running on HP platforms.

In March 1993, a new Channel Partner program was announced — the HP PA-RISC Developer Program. It has grown to become HP's standard program for companies developing software for HP 9000 Workstations and Servers in the United States and internationally.

The program offers ample discounts on development equipment and software with associated lease and rental programs, technical porting support, and up-to-date HP product information. All of this is designed to help both large and small software developers to begin a new partnership with HP or strengthen an existing partnership with the end objective of gaining mutual success in the marketplace.

The HP Channel Partner Support Program builds on the objective of mutual success with a comprehensive offering of sales incentives and subcontractor arrangements to enhance the post-sales service and support revenues for HP Channel Partners. In addition, HP technology financing can combine equipment acquisition, upgrades, application software and HP support services as a convenient, cost-effective package that the Channel Partners offer their customers. — *Brad Fortier is HP's CSO Channels Communication Manager.*

# EAC, Incorporated

*The best part about our services are the people behind them.*

**E**AC Network Integrators, Inc. has been a dedicated partner to HP's customers for over seven years. As the nation's **#1 ranked OpenView Channel Partner**, and the Northeast's **#3 ranked HPUNIX System remarketer**, EAC, Inc. has employed skilled people to achieve the following:

In partnership with HP's Network and Systems Management Division, EAC offers turnkey OpenView management solutions including HP and third-party hardware, software, and EAC consulting services.

In partnership with HP's Network Test Division, EAC uses and sells HP's Internet Advisors, Netmetrix,

and LANProbes for network analysis and capacity planning services.

As an HP Computer Systems Organization Reseller, EAC offers HP UNIX Workstations and Servers plus performance planning and tuning for Lotus Notes, Oracle, and other 3rd party software.

As an HP Enterprise Network Partner, EAC designs and installs corporate backbones based upon HP's Advanced-Stack products. EAC also offers HP's full line of Intel-based PCs, servers, as well as printers.

EAC is the only company in the northeast

positioned to provide comprehensive solutions across so many HP product lines. We also work with complementary, "best of breed", products from other companies in order to offer the best technology solutions for our customers.

## *EAC, Inc.*

12 Cambridge Drive  
Trumbull, CT 06611  
Tel: (203) 371-4774  
Fax: (203) 372-4199  
NYC: (212) 221-3920  
Inet: [info@eac.com](mailto:info@eac.com)

READER INFORMATION NUMBER 185

**HP OPENVIEW  
AUTHORIZED  
CHANNEL  
PARTNER**

**Placing HP & It's Customers  
FIRST**

**EAC**  
Network Integrators

EAC is an HP-focused network integrator with proven experience in the diverse product mix found in multi-vendor enterprise networks.

For more information send e-mail to:  
[INFO@eac.com](mailto:INFO@eac.com) or call 203-371-4774

HP FDDI Advisor  
FDDI RING  
HP Advanced Stack Router  
HP Ethernet Advisor  
HP Advanced Stack 10-Base T Hub  
Ethernet RMON Probe (HP LanProbe)  
HP 800 PA-RISC Server  
HP 715/100 Open View Console with NNM

CIRCLE 185 ON READER CARD

# Don't Break The Chain

*A Look At The Changes And Challenges In The Reseller Channel*

**Hewlett-Packard's** distribution channels are changing. And that means changes in business as we know it. There are two catalysts for the change: the unbridled growth of the computer industry in general (HP's market in particular) and an increasing complexity of computer solutions delivered at a forever lower cost. It's the start of a chain reaction — one that redefines the value chain of supply we call "The Channel."

But it's not just a process that enables a VAR to buy a computer. HP's competency is making complex computing, operating systems and networking products for general use applications. HP has so much business to pursue that it needs channel allies. And every day, an end-user has to figure out how to use those products in the course of conducting their business. So every action and reaction between HP and the end-user matters to those of us in the channel.

The need to service customers with orders of under \$250,000 is especially great. Every sales team is in the hunt for the "Big Deal" including HP itself, as well as every VAR, DAR and systems integrator. In fact, it's dog-eat-dog competitive. This low-end and midrange part of the market will be a profound growth segment. But there are many smaller "bones" out there — in particular the under-\$100,000 deals. However, those are the most difficult to match with a competent, commercial-oriented software provider or integrator. Here's why: To stay competitive, HP must continually increase the productivity of its sales force. So HP must focus on selling to ever larger customers where their vast resources can deliver a compelling value proposition to them. For example, it's getting difficult to pinpoint what unique value HP adds in a \$40,000 Series 918LX upgrade from a Micro 3000.

The software and LAN business in large-scale projects like that goes to specialized providers of those products and services. And end-users are forced to look for additional vendors to complete the implementation. So HP's own sales force has a difficult time constructing a value-added proposition for the under-\$100,000ers. Financially, there's just not enough margin in the order. At least not in the channel's *old model*. In the new chain of supply, HP's channel allies, like Integration Alliance,

connect resellers who can participate in the software, hardware, implementation and training and ongoing support revenue.

Our channel partners are specialized providers of commercial, business-oriented products and services. They are expert at assisting end users to make productive use of the technology provided to *the channel*. In other words, our channel partners assist the end users in deriving value from the technology.

At the low end of the channel — where economics work against larger providers — channel allies work to provide an economically feasible transaction for the reseller. They provide the essential products for the customers to sell, do their configuration work to reduce their labor in the transaction, arrange financing, and streamline their access to HP's computers and resources. Add lead generation programs to reduce the cost of finding the deal and now the low-end deals are productive as well as profitable.

In the midrange portion of the market where every VAR and integrator can look like the next one, allies are trying to differentiate themselves. Integration Alliance, for example, has researched and assembled a data warehousing solution for owners of HP 3000 or HP 9000 systems. It's the first of their diagonal software solutions. Not a horizontal solution like a payroll system, but not quite a vertical solution like a manufacturing or travel agency system. With the pre-integrated sophistication of a diagonal solution, customers can provide a higher value-added proposition to the end user. Creating diagonal solutions lets us serve as a vital member of HP's channel.

So what is an "ally" like Integration Alliance? A distributor? A "technology marketing and delivery company"? Perhaps a "master integrator." Or a "super integrator." We're obviously struggling with the terms. Nevertheless, the focus is on our place in the value chain — providing complex, value-added commercial systems and diagonal solutions to build long-term, value-added relationships between our customers and end-users. — *Ross Duncan is co-founder, senior vice president and chief operating officer of Integration Alliance. Located in Englewood, Colorado, the company is a distributor of open solutions for HP commercial systems providers.*

# Channel Partner Listing

## **AVM Informatique France**

52 Rte de St Genis Laval  
69540 IRIGNY

Tel: 33 78 56 59 13

Fax: 33 72 39 91 69

For US contact : Linksys International Corp  
Tel 310 337 3110 - Fax 310 337 1272

Email : [avm@pobox.oleane.com](mailto:avm@pobox.oleane.com)

GRAPHIC-FAX for OpenMail, OpenDesk, PC Network and Spool HP9000 or HP3000.

No need for fax driver and additional software in each user's PC!

Documents are sent to the fax gateway in original format - Support all clients interfaces - Support MS-Mail & cc:Mail Network, PC Network, Spool HP9000 or HP3000, PCL5, Postscript - Fax status is confirmed by mail to the sender - Topfax Server is native Windows NT application - For large volume using Oracle database - 1 to 128 outgoing or incoming fax lines - Redirect incoming faxes to user's mailbox using ISDN - Supports fax modems Hayes-compatible Class2 and 2.0

## **HICOMP America, Inc.**

P.O. Box 2959

Spring, TX 77383

(800) 323-8863

Fax: (713) 355-6879

WEB: <http://www@hicomp.com>

HIBACK is a high performance backup tool built upon Open Systems standards. HIBACK supports the majority of UNIX systems, NetWare, DOS, Windows, OS/2 and Windows NT. HIBACK supports most storage devices including optical disc jukeboxes and tape autoloaders. HIBACK/UX includes a PC-based GUI which allows user-friendly access to the network's backup and retrieval operations.



## **Distribution Resources Company (DRC)**

5340 South Quebec Street  
Suite 300

Englewood, CO 80111

(303) 889-4500 \* Fax (303) 889-4533

Distribution Resources Company, founded in 1976, is a leading supplier of client-server business solutions for the distribution industry. Our new comprehensive InVision suite of client-server applications utilizes the Microsoft family of development tools. The systems runs on various database servers: IMAGE/SQL (HP 3000), SQL/Server, and Oracle 7 database.



## **Hawthorne Computer**

1001 4th Avenue, Suite 3248

Seattle, WA 98154

Tel: 206 682-9174

Fax: 206 622-5352

Accounting and Distribution software for HP3000 and HP9000. Hawthorne Computer Center markets Great Plains C/S+, Great Plains LAN software along with MCBA software. Professional staff members provide customer modifications, installation services, and support. Offices in Portland, Oregon and Seattle. Please contact Jerry Wade or Bill Johnson at 800-458-6960 or [wbj%hcc@mcimail.com](mailto:wbj%hcc@mcimail.com).

## **Cellular Technical Services**

2410 Fourth Avenue, Suite 808

Seattle, WA 98121

Tel: 206 443-6400

Fax: 206 727-1288

Cellular Technical Services, Inc. (CTS) develops and markets software systems that enable wireless communications providers to rapidly and cost effectively grow their business. The Company's

revenue-enhancement and fraud prevention systems have more than eight years of real-time expertise and experience behind them. This core expertise uniquely positions CTS to quickly deliver additional solutions in direct response to evolving market needs and technology.

PreTect™ is a breakthrough fraud application that goes beyond detection to fraud prevention. Using patented radio frequency (RF) fingerprinting technology, PreTect effectively prevents fraud as it happens today, with fast and accurate first call interdiction, and is strategically positioned for tomorrow's fraud evolutions. The foundation for the PreTect technology is the Blackbird Platform, an expert system that unleashes the power of real-time technology and pre-call information to the wireless industry for the first time.

## **OpenVision Technologies**

7133 Koll Center Parkway

Pleasanton, CA 94025

Tel: 510 426-6477

Fax: 510 426-6486

OpenVision Technologies, Inc. is a leading supplier of systems management applications and services focused on automating the management of business applications within distributed computing environments. Solutions are available for automated operations, application availability and performance, mainframe-class storage and network and system security on leading platforms including UNIX, OpenVMS, Windows, Windows NT and NetWare.



OPENVISION.

# Channel Partner Listing

## **MANTIX Inc.**

1990 North California Blvd., Suite 180  
Walnut Creek, CA 94596  
Tel: 510 937-4477  
Fax: 510 937-4994

CASCADE is an Oracle-based, multi-user, multi-project control system for planning, estimating, budgeting, forecasting and resource management at department, divisional or corporate levels.

CASCADE focuses on financial management by integrating cost, schedule and resources - whether they are initial proposal estimates, detailed budgets, earned value calculations, actual collections, or variance analyses.



## **Trident Systems**

102001 Lee Highway, Suite 300  
Fairfax, VA 22030

Xtouch for HP is the touch screen solution for HP workstations, and Xstations. The Xtouch solution consists of touch screen hardware, touch screen software, and touch screen installation services (if needed). Software designed for a mouse, and running on HP hardware will immediately work with touch on the monitor screen.

TR:IDENT

## **EDI Solutions, Inc.**

2051 Killebrew Drive, Suite 220  
Bloomington, MN 55425  
Tel: 612 858-1100  
Fax: 612 858-1150

EDI Solutions, Inc. provides Electronic Data Interchange (EDI) translation and mapping software and support services for the HP environment. As an HP Premier Solutions Partner, EDI Solutions offers realtime or batch translation software, a migratable mapping tool, dependable customer service and

innovative consulting for HP3000, HP9000, and PC environments.

## **EDI Solutions**



## **Integration Alliance**

5445 DTC Parkway, P4  
Englewood, CO 80111  
Tel: 303 770-5980  
Fax: 303 771-4758

Integration Alliance Corporation is a major distributor of open systems products, solutions, and support services that meet the needs of complex systems and software solutions providers in the Hewlett-Packard commercial computing environment. IAC helps high-end VARs, systems integrators, application developers, and reengineering consultants sell, configure, deliver, and support the HP 3000 and HP 9000 business servers and workstations.



## **Vanguard Technology, Inc.**

11211 East Arapahoe Road  
Englewood, Colorado 80112  
Tel: 800-840-6090  
Fax: 303-799-9297  
email: [inquire@vanguard.com](mailto:inquire@vanguard.com)

Vanguard Technology, Inc. provides solutions for the open, client/server environment, ranging from mass storage subsystems to networking and data communications products to fully integrated, heterogenous turn-key data management solutions including HSM, archival and backup/restore.



## **R SQUARED, INC.**

11211 East Arapahoe Road  
Englewood, Colorado 80112  
Phone: 800 777-3478  
Fax: 303 799-9297  
email: [inquire@r2.com](mailto:inquire@r2.com)

Serving the UNIX environment, R Squared, Inc. offers a complete line of add-on peripherals for SUN, SGI, IBM and HP workstations, including high capacity disk and tape drive systems and optical libraries.

R Squared provides a value-added, UNIX compatible product to increase storage capacity and decrease access time. All products are backed by R Squared's experienced, factory-trained technical support and service staff.

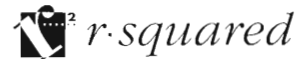

## **DB-NET, Inc.**

6292 Busch Blvd.  
Columbus, OH 43229  
Tel: 614 436-6565  
Fax: 614 847-1247

DB-NET, Inc. provides automated migration services both to and from HP 8000 MPE machines. DB-NET specializes in migrating application code and IMAGE data to a UNIX-based open system. DB-NET can convert data from IMAGE to most relational databases including Oracle, Sybase, Informix, etc. The migrated code will have the same look and feel as the legacy system, therefore eliminating retraining for end users. DB-NET offers a complete service, not mere tools to struggle with on your own.



# Another world's fastest chip

## H-P claims its PA-8000 will outperform others

It's a title that seems to shift on a monthly basis, but Hewlett-Packard Co. announced a chip design Monday that it says deserves the title of the world's fastest microprocessor.

The PA-8000 chip will be part of H-P's line

instruction-set computing. H-P's workstations have been the center of the industry for years.

analyst A says the new chip will be a major step in the evolution of the architecture.

# IBM accelerates revamp of OS/400; PowerPC version due later this year

As IBM ships the last of its promised OS/400 Release 3.1 components this week, it is paving the way for delivery of a completely redesigned, PowerPC-based OS/400.

their respective server platforms.

The stakes are high. IBM claimed an installed base of 300,000 AS/400s at the end of 1994, with sales growing by 50,000 units per year.

# IBM big iron revamps bode well for 95; Client/server OS, 64-bit architecture await AS/400

IBM has spent the past few years trying to answer questions about the future of its mainframe business in a client/server world. It will start to find out whether the big iron got it right.

A server-oriented rewrite of the operating system is supposed to be completed by February, following a

eagerly awaiting the coming makeover. *Mark Edward*

# IBM reiterates PowerPC commitment

IBM is expected to ship its long-awaited PowerPC desktop systems in June, but with a beta version of OS/2 for PowerPC. Lee Reiswig, general manager of the Personal Software Products division, said at an analyst conference in Orlando, Fla., last week.

# Shortages hit 486 suppliers

A worldwide shortage of 486 chips is starting to make life difficult for system vendors as Intel shifts semiconductor production in favor of Pentium chips.

Advanced Micro Devices says it is meeting demand for

# HP lifts curtain on 64-bit chip, keeps mum on Intel project

Determined not to lose mind share in the processor game, Hewlett-Packard Co. last week provided a glimpse of its 64-bit PA-RISC 8000 architecture, which is still a year from delivery.

At the same time, officials at HP and Intel Corp. all but denied a wire service news report that said the results of the two companies' collaborative microprocessor development would reveal a joint project in 1997 as Intel

Barrett, who is

## IN TUNE WITH:

In showing that the 64-bit UltraSPARC architecture is better than 64-bit

By the end of the year, Larry Inman, HP's chief architect, doesn't see the value

# IBM, Motorola To Announce 64-bit PowerPC

64-bit PowerPC architecture, which IBM and Motorola will announce together. The chip promises dramatic improvements in multiprocessing performance over the 601, 603 and 604 chips, sources

to come. The chip is expected to be twice as fast as the 604's cache. The chip is expected to be twice as fast as the 604's cache.

# IBM, Motorola show off PowerPC 620 prototype; volume shipment expected in '95

IBM and Motorola are announcing the PowerPC 620 this week, the most advanced implementation of the PowerPC architecture to date.

As part of the announcement, the two companies introduced the first 620 prototype, with sample shipments to follow in the second quarter of 1995.

Volume production is expected to begin in the second half of 1995.

# 1997 date set for delivery of HP/Intel P7

Intel Corp. acknowledged last week that the P7 will be the first chip to come out of the alliance formed with

per second (see "Pentium now, VLIW later," Jan. 30, page 1). The basic concept of the VLIW is to have the com-

# Sun announces untested 64-bit chip

Sun Microsystems Inc.'s Sparc Technology

compared to Digital's Alpha AXP 21164, which has a SPECint92 rating of 330.

HP, Sun's biggest rival, is shipping a PA-7150 processor that has a SPECint rating of 135 and next month will introduce the PA-7200, which is expected to have a SPECint92 rating of about 150.

Sun acknowledged the performance gap but

# PowerPC Much hype, little de

PC Week via First: Hannover, Germany - IBM, Apple Inc., and Motorola Inc. showed little restraint in hyping the

but in private, officials from the vendor standard isn't ready for prime time.

A range of PowerPC processors in the pipeline that continues to keep the PowerPC from breaking into the PC mainstream and winning converts in the PC mainstream.

going to take two to three years for us to really change the market," said Hester, general manager of IBM's Systems and

Division, in Austin, Texas. "I don't have illusions that this overnight disc-

# INTEL-HEWLETT-PACKARD ALLIANCE SEEN RALLYING A 64-BIT MICROPROCESSOR STANDARDS EFFORT

There are scant details of how Hewlett-Packard Co. plans to introduce technology developed under its alliance with Intel.

traffic. And the massive 64KB Level cache, most previous processors had 32KB or



# IT'S NICE TO SEE IBM AND HP FIGHTING OVER WHO WILL BE NUMBER 2.

*In fact, it's downright heartwarming. Digital, of course, beat both of them to 64-bit computing long ago. And while neither one has a 64-bit machine to sell you, we're now on our second generation of*

*64-bit Alpha-based workstations and servers. Machines that offer price/performance leadership*

*at every level. For example, our new AlphaStation™ 250 system is half the price of the comparably performing HP workstation! While our new AlphaServer™ 8200 and 8400 systems are the first and only servers capable of running the newest 64-bit database products*

*—letting your application directly address up to 14GB of*

*data in main memory, and giving you performance gains of up to one hundred times over 32-bit enterprise systems. Alpha-based systems run thousands of applications—including the ones you need*

## **Digital Ships Its 100,000th Alpha System**

Digital Equipment Corp. reports it shipped its 100,000th 64-bit Alpha system. The milestone is significant, in our opinion, in that competitors IBM, Sun, and Hewlett-Packard have yet to ship their first 64-bit product.

*most. And, thanks to the enormous capacity and scalability of 64-bit architecture, they'll work with your present equipment, and grow almost limitless as your business grows. Sure, it's possible that HP*

*or IBM really will have 64-bit machines, eventually. But even when they start offering real-world 64-bit products, it'll still be years before they'll have been as thoroughly tested and evolved as ours are right now. So why wait? Whatever your business, whatever your budget, you can do what thousands*

**digital**™

*of companies all over the world have done—and what IBM and HP have been unable*

*to do—have a 64-bit computer you can call your own. For more information, contact your Digital business partner. Or call 1-800-DIGITAL. Or reach us via our Internet address: [moreinfo@digital.com](mailto:moreinfo@digital.com).*

### **Digital's lucky chip**

*...sales of systems based on the Alpha chip have taken off, jumping 66% in the past year, and now exceed VAX sales. The chip excels at handling thousands of concurrent users—which is why regional phone companies*



# HP OpenView Users: Cautiously Optimistic

**It's a curious fact of life that the public often embraces fallen heroes even after humiliating**

personal defeats. Comebacks are not unusual for famous athletes, actors and even politicians who admit past addictions to drugs, booze, gambling and other more malevolent temptations of life.

Occasionally, the buying public forgives computer vendors, too.

Albeit, vendor mistakes are less sensational — such as missing shipment delivery dates — but they do have adverse affects on customers.

Back in February, most HP OpenView Network Node Manager (NNM) users were discontent, if not downright angry, over HP's year-long delay in delivering scalable, distributed network management capabilities in the code-named Tornado release. But the mood of the 1,000 or so attendees at the recent HP OpenView User's Forum meeting in Seattle, Wash. was actually close to being upbeat. "I think we're recovered from the shock of the Tornado slip," said one OpenView customer I spoke with, "now we're ready to forge ahead with whatever HP plans to provide us."

Indeed, HP has learned from last winter's mistake, and is now setting more practical, short-term goals for itself in delivering future network

management capabilities. You'll notice I used the word "network management." As far as systems management goes, HP is charging full-steam ahead enhancing the OperationsCenter and PerfView offerings, indicating no lack of internal funding for those strategic product areas.

But back to network management — the primary hot-button for most of the OpenView Forum attendees. HP seems to have trouble finding enough funds to fuel aggressive network management product development. Not to criticize of course — actually, HP is taking a very practical approach here, and the balancing act may well pay off.

HP has decided to divide its NNM "Tornado" release into two parts, the first of which will be delivered in October 1995. In this first release, dubbed "Dust Devil" by some OpenView customers, HP has split off the GUI process from the NNM server. In other words, you can use one or more workstations to create and display the map of your network, and use another workstation to poll network devices and store non-graphical management data. In theory, this will yield performance gains of up to 40 percent — meaning that you may be able to allow several operators, instead of just one, looking at the network using OpenView NNM without suffering significant performance degradation.

"Dust Devil" will undoubtedly ease the pain of a certain percentage of OpenView NNM customers straining to manage several thousand network devices from one console. But cus-

tomers with networks exceeding 2,000 or 3,000 nodes must still make do by splitting the network into multiple domains, each managed by a separate copy of NNM, none of which can communicate with the other.

But the next release of OpenView NNM — Tornado Part II — may address that problem, at least in part. But don't expect a full solution any time soon. And don't expect any premature announcements about fully distributed CORBA-based solutions; HP is understandably skittish now about unveiling any product plans before their time.

However, we can and should expect lots of activity on the systems management front.

### FOR GOOD MEASURE

In particular, the PerfView folks have introduced a new combination of fault and performance tools called MeasureWare, allowing administrators to more quickly discern the root cause of application performance anomalies. MeasureWare collects data from several types of HP agents — network traffic statistics from HP NetMetrix PowerAgents, server stats from PerfView/PCS, database performance indicators from BMC's Patrol package, system message data from OperationsCenter and, most importantly, data on application behavior courtesy of new MeasureWare agent features — combining all of this glorious information into one visual display. And it's more than just a listing of collected event messages.

For example, the MeasureWare display can graphically depict application response time and overlay that graph (at the operator's discretion) over graphs of network traffic, server stats and database metrics. The benefit is that operators now have some real-time clues as to why the customer order entry system (or any other mission critical application) is having problems. Although MeasureWare itself doesn't diagnose the primary cause of failure, it makes the source of trouble much easier to spot. If application response time spikes at the same point server CPU utilization does, but network traffic stats and database metrics are holding steady, the

administrator has a pretty good idea that the server is the most likely candidate for harboring the source of trouble.

Of course, all of this visual power doesn't come without a price. You need NetMetrix PowerAgents on every network segment to be graphed; likewise, a PerfView/PCS (now MeasureWare) agent must sit on each critical server, and you need to put the MeasureWare hooks into the mission-critical application, indicating the beginning and ending of each transaction to be measured. If it sounds like a lot of work and expense, look at the alternatives — do it yourself integration (always a bigger project than you anticipate) or maintaining the status quo — continue relying on guesswork. Each end-user organization has a different threshold for maintaining a trial-and-error style of network and systems management.

Besides purchase price, there is another potential downside to this otherwise positive MeasureWare announcement. Several OpenView customers attending the Forum expressed anxiety about HP's determination to wed systems and network management together at a single console. "Where are we going to find these super technician operators who understand routers, hubs, servers, databases and applications all at once?" one user asked. "I have a hard enough time keeping good people on board who have expertise in just one of these areas!"

Network managers in the trenches can't ignore these very human issues, so they are quite understandably cautious. Network managers may forgive vendors for missing shipment deadlines, but they never forget why they forged the customer/vendor relationship in the first place. They've got real-life problems to solve, and very real constraints within which to solve them.

*Huntington-Lee's Internet address:  
0004463809@mcimail.com*

Would you like to continue to see articles on this topic?  
Circle on reader card  
yes 306 no 305



## The Power of Efficiency

### *EDI WINDOWS™* **Enabling technology for business in the '90s**

Successful businesses across North America know that Electronic Data Interchange (EDI) is bringing true automated efficiency to a host of everyday tasks formerly done by hand. *EDI WINDOWS* enables the link from your **HP3000, HP9000 and other open system platforms**, to those all-important customers and suppliers, for purchase orders, quotations, invoices and much more.

*EDI WINDOWS* supports X12, EDIFACT, TDCC standards and many more. In the electronic marketplace, *EDI WINDOWS* can work for you.

### **For powerful solutions, call 1-800-ANSWERS**

M. B. Foster Associates Limited  
50 Water Street  
P.O. Box 580  
Chesterville, Ontario  
Canada K0C 1H0

Tel (613) 448-2333  
Fax (613) 448-2588



*Your Integration Software Supplier*

*EDI WINDOWS is a trademark of trinary systems inc.*



# The Hype And The Hope Of 95

**For the last year you've heard rumors, claims and stories about Windows 95, and now it's finally**

time. As we go to press, Microsoft maintains that Windows 95 will be available for release on August 24. This means that by the time you read this, your local computer store may well be swamped with people buying Windows 95.

Since January, I've been beta testing Windows 95. And for the most part it's been a thoroughly enjoyable experience. But recently, I removed Windows 95 from my system. And so are a number of other beta testers I know. On my desktop Vectra PC, I'm re-installing Windows for Workgroups connected to a Windows NT Server. Someone else I know is going to try Windows NT. Still another has given up on Microsoft products altogether and is using the public domain Free BSD on his laptop. But then, he's always been a UNIX sort of person. We should be just the kind of people who are embracing Windows 95 with a vengeance, yet we all have decided to pass on this generation of new, way cool technology. Why?

After I installed Windows 95, I was looking at HP's NewWave operating environment. The concept of documents existing as icons on your desktop,

or stored within folders, sure looked familiar. Add a waste basket, a number of "tool" icons, and you pretty much have the NewWave look-and-feel. When Microsoft and HP were found to have not violated Apple's Macintosh interface, it was a pretty good bet that Microsoft would license some of the NewWave technology. This insures that if Apple were to challenge the Windows 95 look and feel, Microsoft can claim the interface is based on the licensed HP technology.

However, the problem is that Microsoft's new user interface doesn't provide me with any compelling reason to switch from the Windows 3.1 interface I've been using successfully for the last five years. The toolbar, the "My Computer" icon, and the "Network Neighborhood" icon are just not enough to make me change the way I use my system.

My friend who is switching to Windows NT has felt nothing but frustration since he first installed Windows 95. The promise of a technology that would recognize configuration changes seemed like the right choice for a laptop user who is only sometimes connected to a network.

The problem is that my friend has yet to find a PCMCIA network card that is supported under Windows 95 that will automatically recognize whether it is attached to a network or is on the road. In fact, I think he would have been happy if he could just find a PCMCIA network card that would let him reliably work on a network at all. He also was

frustrated by what appeared to be an inherent capability for the newest Microsoft C++ compilers to generate code that reliably crashed Windows 95 to the point that a power-on reset was needed to reboot. That's not much of an endorsement for an operating system that is supposed to protect multiple tasks from other errant processes.

My UNIX-oriented friend never really had his heart in Windows 95; sometimes I think he just wanted to try it so he could bash Microsoft. He would rather write his own drivers than use a commercial product anyway. His UNIX bias notwithstanding, he found that Windows 95 just didn't have the network capabilities and tools he needed to do his job diagnosing network and system problems.

#### A BAIT AND SWITCH?

Shouldn't we have expected these kinds of problems when testing an unfinished software product? Maybe. Still, I think if a number of "power

users" have found no real need to switch to Windows 95 yet, why would your average everyday user? After all, who do novice users turn to for help? Right — power users. And what will they do when the power users can't or don't support an operating system?

On the other hand, Windows 95 does offer a number of additional intuitive ways to perform tasks that, under Windows 3.1, are far from intuitive. And some novice users I know seem to like the desktop analogy. But there's a good chance that the only people who will like Windows 95 are the people who haven't yet used Windows.

Will Microsoft lose a fortune on Windows 95? Hardly. Nearly all the technology that's in Windows 95 will become part of other Microsoft operating systems including Windows NT and the future OS known under the project name of Cairo. By late December, we'll see the Windows 95 user interface on Windows NT. And I don't think it will be long after that we

will see something akin to an "NT Lite," perhaps a workstation version of NT that will need only 8 MB of memory. Once you have a real multitasking, protected OS that works on today's typical desktop system, why would you want to use anything else. OS/2 Warp fans, take note.

As I see it, Microsoft will push Windows 95 in the press and the retail channel while quietly moving Windows NT into their major accounts. Over the next three or four years, you won't notice Windows 95 fading out and before you know it we'll all be using Windows NT.

Would you like to continue to see articles on this topic?  
 Circle on reader card  
 yes 310 no 309

**See us at**  
**UNIX Expo '95**  
**Booth #2223**  
**and Network1 + Interop '95**  
**Booth #6655**

**Solaris/Intel**.....**Solaris/Intel**.....**HP/UX**.....**SunOS**.....**Solaris/SPARC**.....**Solaris/Intel**.....**Solaris/Intel**.....**Solaris/Intel**.....

**YOUR WORKSTATION WITH AURORA ON BOARD**

**LAN** — **WORKSTATION** — **WAN**

**TURN YOUR WORKSTATION INTO A WAN ROUTER. AND SAVE A BUNDLE.**

**Node-Resident Networking**

**R**outers don't have to be a big investment. Aurora lets you use the workstation power you've already got. Our node-resident routers are powerful, synchronous WAN communications servers that offer:

- ▶ **Compatibility with X.25, SNA, PPP, Frame Relay, and HDLC/SDLC**
- ▶ **Port-level selectability for protocol, speed, sync or async**
- ▶ **On-board intelligence to offload workstation**
- ▶ **RAM buffers for data integrity**
- ▶ **A developer's kit for easy integration into the enterprise**
- ▶ **Use with SunLink Software**

Find out how Aurora can help your workstation communicate better. **617-290-4800**

**Call today for a FREE Primer on Node-Resident Networking.**

Or email: [info@auratek.com](mailto:info@auratek.com)

**AURORA TECHNOLOGIES**

.....**HP/UX**.....**Solaris/Intel**.....**NODE-RESIDENT NETWORKING**.....



## The Dark Side Of The Force

**In June, I accepted HP's invitation to attend the Paramus, New Jersey stop on the CSY Road**

Show. It was billed as "A Glimpse of the Future of the HP 3000." The four strategic directions outlined for the HP 3000 and MPE/iX were: build on the HP 3000's strength in OLTP applications; enhance its ability to integrate smoothly into multiplatform environments; provide a smooth evolution to client-server computing; and deliver innovative solutions and services.

The multiplatform environment has three components: the desktop, the network and the server. On the desktop, most commercial organizations today have some combination of DOS, Windows or OS/2, with Windows the clear leader (Mac and UNIX workstations are specialized players on the desktop). Then there is the network operating system tying all these desktops together and creating shared resources; here, Novell's NetWare dominates. The server situation is somewhat muddled because the distinction between server OS and network OS can be fuzzy.

No one server platform dominates. However, Burke's First Axiom of IS Management states: the fewer platforms you support, the lower your personnel requirements, the lower your software

costs and the lower your support costs. Or, your IS operating costs are proportional to the number of platforms you support: the more platforms, the higher the costs. This is especially true for small-to-midsize organizations. A reasonable goal then is to standardize on one server platform.

Back to strategic direction number two. When HP talks about integrating the HP 3000 into a multiplatform environment, it is talking about the desktop-network-server model. Right? Well, not exactly. In explaining the evolution of strategic direction number two HP found that 35 percent of its customers have at least one UNIX system in their shop. If the obvious follow-up "Why do you have at least one UNIX system?" was ever asked, the answers are being kept close to the corporate vest.

That's OK though, because I am going to tell you why. You see, Burke's First Axiom comes from the gut, you instinctively know it is correct. So, if you violate the Axiom, it can only be for one overriding reason: your server platform of choice cannot run some application or perform some task that business reasons require.

Last month, I called the HP 3000 the best server platform that no one knows about. However, beware of the Dark Side of the Force — functionality the HP 3000 does not have that could keep it from being competitive with UNIX servers.

A short, and definitely not exhaustive, list of functionality currently

# HP USERS — GANG UP WITH VCX

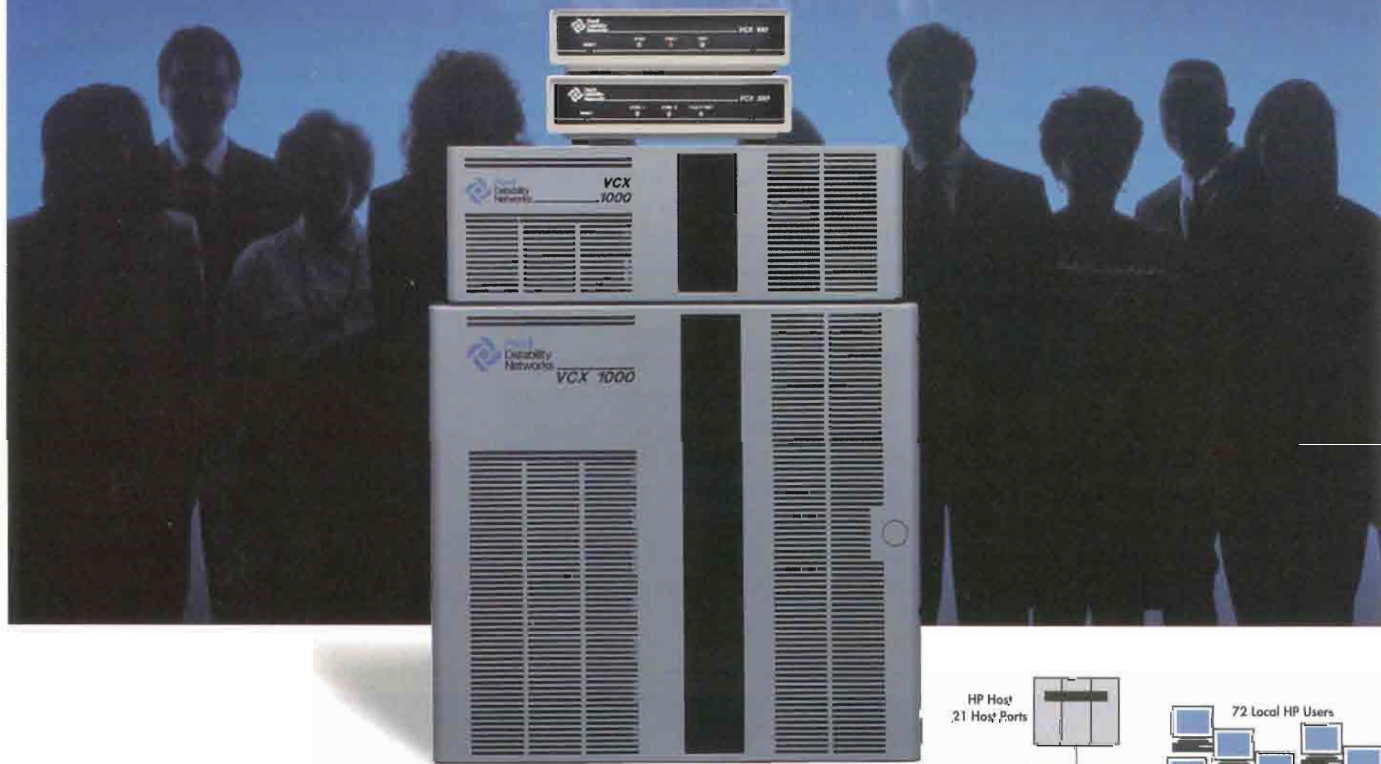

## AND EXPAND YOUR WORLDWIDE CONNECTIONS!

Has your business grown to the point that you now have multiple remote sites? What do you do?

**Buy a Penril remote port concentrator and gang up on your host.**

The VCX is an extraordinary port concentrator that extends the reach of your HP system directly to all of your remote offices. This is done without changing your existing communications network — and without ever adding more ports to your HP host. You connect more asynchronous terminals, printers and PCs in your network than computer ports available. AND SAVE MONEY!

**Plus, VCX does port contention.**

Although you can only connect the same number of concurrent users on your host that you are licensed to support, with VCX, everyone has a chance to grab those connections. The host ports are shared over your network — and if a port isn't available, you're put into a queue and told of your position. If you don't have time to wait, just select another resource or service on your network. AND SAVE TIME.

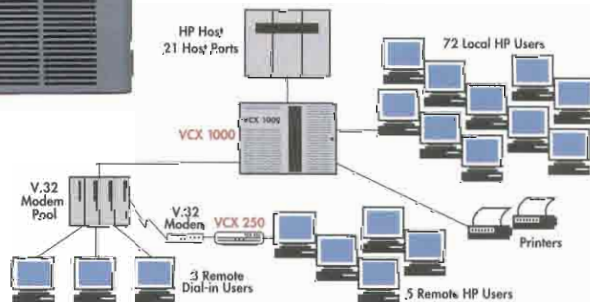

And with VCX, modem pools for dial-in users are no problem. Depending on your location and tariff, the VCX can provide the lowest cost trunk to get remote users on your host computer. Protocols such as ISDN, Frame Relay, X.25, Leased Lines and Dial-Up Lines are all supported.

Isn't it time you expanded your horizons? To receive more information on our exciting VCX product line, call **1-800-4-PENRIL**. We'll be happy to show you how to gang up on your HP host.



available from HP on the HP 9000 but not on the HP 3000 is as follows: C++ and Smalltalk; HP Softbench; OODCE; certain Internet connect functionality; X window support without the need for an HP 9000; compiler optimizing levels such as are available under HP-UX; HP's Intelligent Warehouse; and a desktop version of the HP 3000 (scales up but not down).

Concerning C++, Smalltalk and HP Softbench, I have one sentence that says it all: Build it and they will come. I practically fell off my chair when one of the roadies proudly noted, as an example of the HP 3000's interoperability with other platforms, that most of the development work on the MPE/iX operating system is done on UNIX workstations.

Rumor has it that by the time this hits your IN basket, HP will announce some kind of support for the GNU C++ compiler, g++, on the HP 3000. This is good. Much better would be the addition of an MPE/iX version of

the HP-UX C++ compiler.

DCE will be available on the HP 3000 in 1995 (See the April 1995 "Integrating Your HP 3000"). HP is promoting an object-oriented software tool for developing DCE applications called OODCE. It only runs on the HP 9000. A stumbling block to porting it to the HP 3000: OODCE requires the HP-UX C++ compiler.

Data warehousing, the ultimate database application, is one of the more prominent concepts du jour this year. Did you know HP has a product called the Intelligent Warehouse that it is actively promoting? Only runs on the HP 9000.

However, I continue to applaud HP, and especially CSY, for being proactive in seeking out customer feedback. The danger is in going too far, relying solely on feedback to set direction. HP must be proactive about providing functionality that customers *might* need. If HP had surveyed customers in the 1970s and based its

designs for the HP 3000 solely on the results, there would be no IMAGE today. And no HP 3000 either!

Today, I do not need any of the functionality that I noted is missing from the HP 3000. One of the things that makes life constantly interesting though, is I do not know what I might need tomorrow. However, if business reasons dictate the need for functionality not available on the HP 3000, then despite nearly 20 years of satisfaction, I will seriously look into migrating to a server platform that will meet all of my needs. The HP 3000's ability to interoperate with UNIX will only make the migration easier, not stop it. This is how the HP 3000 will die if changes are not forthcoming, slowly bleeding to death.

*Burke's Internet Address:*  
[TCDN96A@prodigy.com](mailto:TCDN96A@prodigy.com)

Would you like to continue to see articles on this topic?  
Circle on reader card  
yes 308 no 307

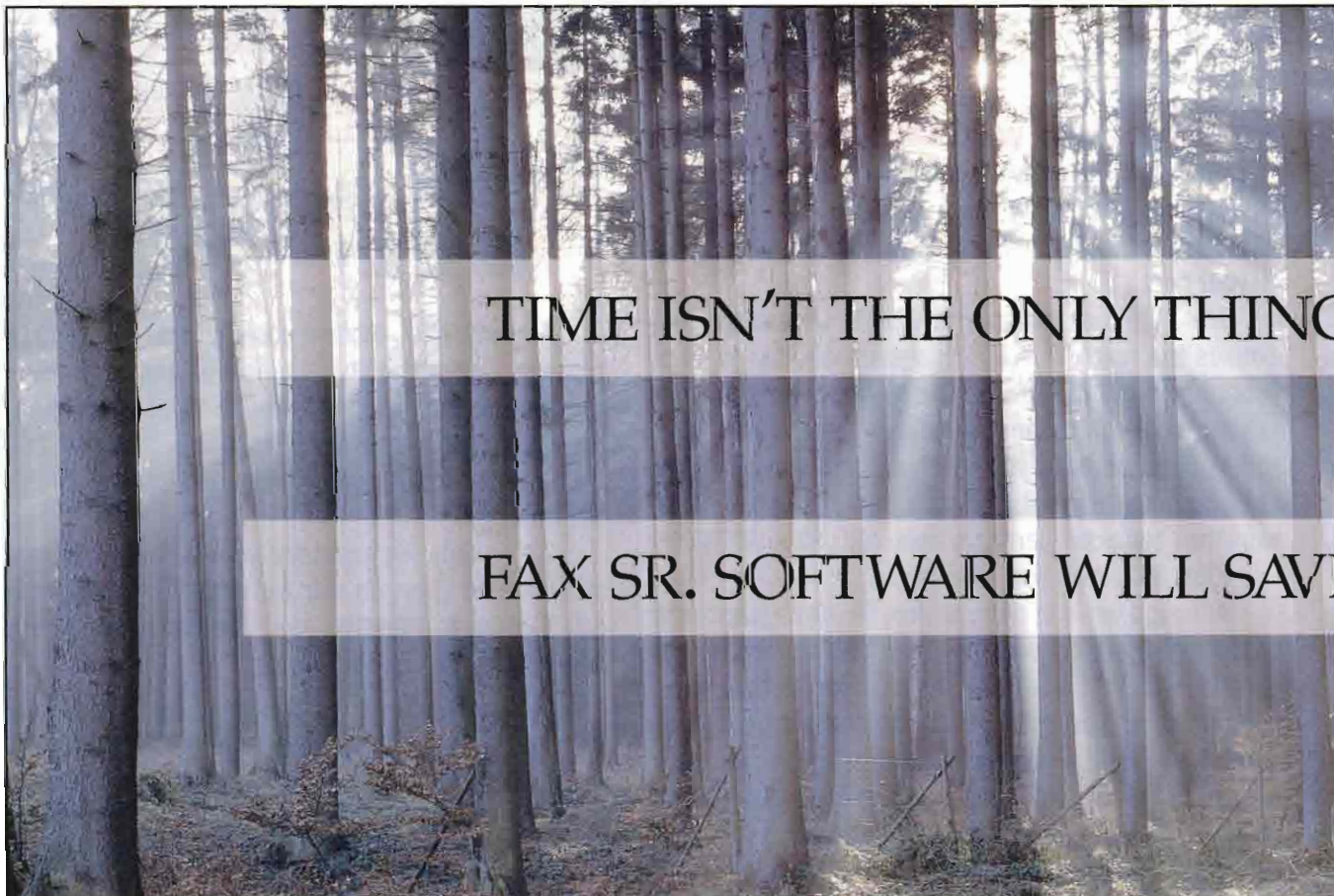

TIME ISN'T THE ONLY THING

FAX SR. SOFTWARE WILL SAVE



# Terabytes of CD-ROM Data Online



CONCORDE  
TECHNOLOGIES



Channel  
Partner

- **CD-ROM Networking Software**
- **CD-ROM Jukebox Libraries**
- **CD-ROM Towers and Drives**
- **CD-ROM Network Servers**
- **CD-ROM Recording System**

Presenting the complete networking solution that inexpensively provides massive quantities of CD-ROM data transparently to UNIX, NFS, NetWare, LAN Manger and AppleShare clients.

For more information, call

**Concorde Technologies, Inc.**  
at **(800) 359-0282.**



HP 9000 Systems • Application Software • RAM Memory • Mass Storage Peripherals • Accessories

CIRCLE 232 ON READER CARD

## INTRODUCING PAPERLESS NETWORK FAXING THAT'S POWERFUL, SIMPLE TO USE, AND SURPRISINGLY AFFORDABLE. FAX SR. FROM OMTOOL.

With the Fax Sr. family of multi-platform fax automation software, you'll not only save the volumes of paper associated with traditional hand-fed faxing, you'll save your organization lots of time and money. Available for VAX/VMS,



*Eliminate the paper and time waste of traditional hand-fed faxing.*

AXP/Open VMS, AXP/OSF-1, and now Windows NT and HP-UX, Fax Sr. is the only network fax software that can truly grow with your company. Best of all, Fax Sr. is easy to install and even easier to use.

Everyone will be using Fax Sr. in less than an hour, to fax documents, pictures, graphics and scanned images all with laser quality. Without leaving their desks. All this productivity and more starts at just \$995.

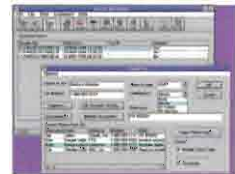

*Save more time with the ease of true point-and-click operation.*



**OMTOOL**

Call 603-898-8900 or 800-886-7845. Ask about our FREE Guide to Network Faxing.  
Internet: [sales@omtool.com](mailto:sales@omtool.com)

CIRCLE 130 ON READER CARD

# Is Your Business Data Hard To Access?

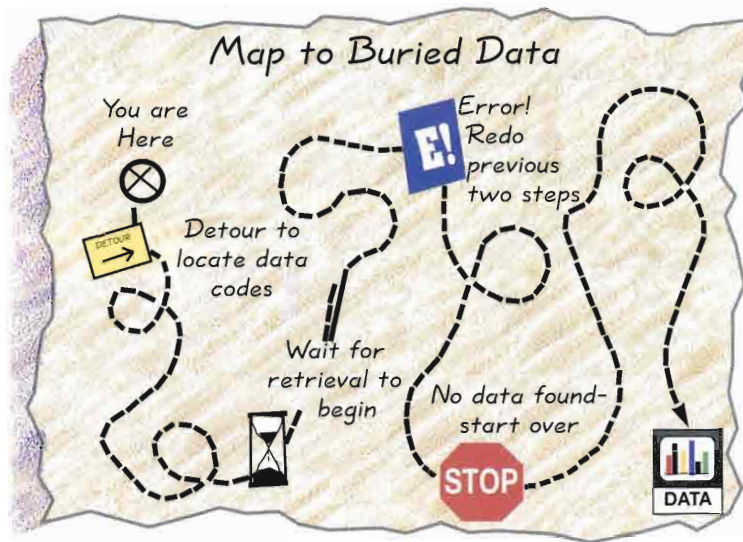

You might need a map to find your data in some financial software applications. And even then, some of that data may be buried so deep in the system that it takes forever to retrieve.

You'll have no such problems with FMS II, Mitchell Humphrey & Co.'s complete suite of financial software. Our decision support tools give you direct, fast access to the data you need, when you need it.

FMS II includes these easy-to-use, yet powerful and flexible PC-based tools:

- **FMS-ONRAMP**, a multidimensional data analysis and presentation tool which features instantaneous drill downs, drill arounds and multilevel consolidations for an almost limitless number of dimensions.

- **FMS-ACCESS**, a report writer which can be used to create both ad hoc and production quality reports, as well as for other functions such as data base development and forms creation.

- **FMS-EXEC**, a two-way data transfer application that can be embedded in spreadsheets, word processors and other Windows-based applications.

Server-based inquiry, report writing and budgeting tools are also available in the system.

Each decision support tool may be used with any of the FMS II financial systems, including: **General Ledger, Accounts Payable, Accounts Receivable, Fixed Assets, Project Accounting, Purchasing, Inventory Budgeting.**

The tools are also used with FMS-DSS, exciting new decision support system Mitchell Humphrey & Co. software is portable across the HP 3000 and HP 9000 platforms, as well as a wide variety of data bases, networks and graphical user interfaces. You can also mix terminals and PCs in a way that allows you to meet the special needs your organization, while minimizing the impact on your budget.

So if you're looking for financial management software with direction, contact

Mitchell Humphrey & Co. at **(800) 237-0028** for a free copy of our software demonstration diskette.

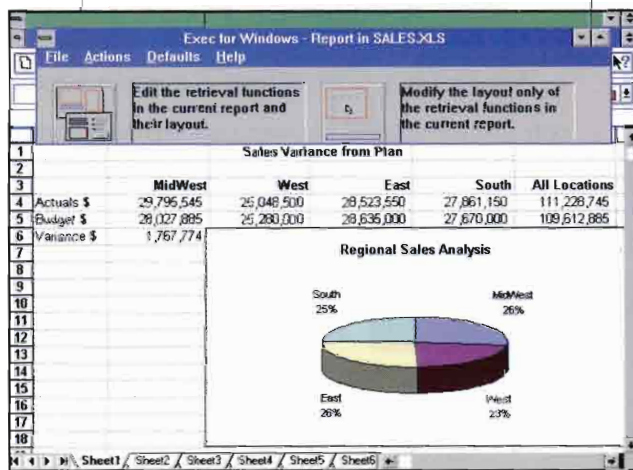

*FMS-EXEC allows you to download and upload data directly from within your choice of spreadsheet environments.*

CIRCLE 154 ON READER CARD

See us at INTEREX, Booth #1020

## MITCHELL HUMPHREY & Co.

Exceptional Software for Exceptional Organizations © 1995 Mitchell Humphrey & Co.



# *new* Products

## SOFTWARE

### Accordance Corp. Enhances Intermail 1.1

Accordance Corp. introduced an enhanced version of its client-server electronic messaging engine, Intermail 1.1.

Intermail 1.1 includes the following enhancements: support for relational databases (Oracle and Informix) to store messages in the same manner as mission critical data; multithreading servers that better leverage UNIX system resources and scale with additional CPU power; an extended MAPI Service Provider Interface that allows all MAPI clients to access the services of the Intermail Messaging Engine; a Post Office Protocol 3 (POP3) interface that allows clients which support POP to use the services of the Intermail Messaging Engine; and a directory broker that allows multiple Message Store Servers to deploy in a distributed environment. Intermail costs \$80 per mailbox. It operates on Solaris, SunOS, UnixWare, SCO UNIX and Irix servers. It also supports X.400 '88, SMTP and MIME natively.

Contact Accordance Corp., 20 Maguire Rd., Lexington, MA 02173; (617) 674-0100.

*Circle 400 on reader card*

### Technikal Inc. Updates QMS

Technikal Inc. released QMS (Queue Management System), an enhanced multibatch controller for the HP 3000. QMS increases control and throughput by allowing up to 100 independent batch queues, each with numerous controlling options.

With a Windows-style interface, QMS runs on any terminal supporting ANSI codes. QMS increases throughput by automating the management and flow of all types of jobs. QMS does not require any modifications to your existing jobs or

applications and is designed to operate as a standalone product or in conjunction with third-party job schedules. Using standard MPE wildcards, QMS can be set up and running in minutes.

QMS also has automatic job rerouting, allowing for the most efficient throughput possible. Other features include a 16-character queue name, schedule and time-of-day parameters for each queue, override input priority, bypass and notification parameters for each job, interactive "help," multiple configuration files and an enhanced **:SHOWJOB** command.

QMS is available for the HP 3000 and costs \$999.

Contact Technikal Inc., P.O. Box 14854, Clearwater, FL; 34629.

*Circle 399 on reader card*

### Innovative Software Introduces Power Center

Innovative Software announced Power Center.

It provides enterprisewide automated system management, including a comprehensive Mission Control Station that graphically manages an entire computing environment from a single location.

Power Center automates the task of problem detection, containment, investigation and resolution with a highly configurable sensor and event management mechanism. It automatically corrects system problem wherever and whenever they occur, according to each company's individual "lights-out" policy.

Key components include; system problem monitor (Power Center/SPM); enterprise notification system (Power Center/ENS); mission control station (Power Center/MCS); and PUMA architecture.

Contact Innovative Software, 5261 S. Quebec St., Ste. 250, Englewood, CO 80111; (303) 220-1500.

*Circle 398 on reader card*

## MYTH:

Data warehousing  
does not exist  
for the HP3000.

## FACT:

Turnkey HP3000  
online data warehousing  
and selective offline  
archiving is here!

DB/Access reorders, extracts, transfers, deletes and restores selected data, *without scripting or programming!*

### ✓ Simple.

The block mode screen interface provides unlimited field value selection.

### ✓ Powerful.

Automatically builds and/or links multiple databases, datasets and files in one pass.

### ✓ Flexible.

Moves data between IMAGE, KSAM, flat files and tape. Cross-platform downloading to RDBMS. Integrates with OMNIDEX and SUPERDEX.

### ✓ Easy.

Creates meaningful test data in one step, without limits on criteria or the quantity of fields selected. DB/Access saves many programming hours.

For FREE demo contact:

## Datastructure

246 First Street, Suite 205  
San Francisco, CA 94105  
(415) 495-7484 Fax (415) 495-7485



All trademarks are the property of their respective owners.

CIRCLE 231 ON READER CARD

## i2 Technologies Releases TIPS

i2 Technologies announced the release of its Truly Integrated Planning System (TIPS) a decision support and execution software that plans the complete supply chain concurrently.

TIPS enables businesses — including suppliers, manufacturers, distributors, transportation companies and customers with the same supply channel — to synchronize all segments of the demand/

fulfillment, and achieve quantum improvements in responsiveness and efficiency.

TIPS allows for concurrent planning of all segments in real time, while taking all constraints (such as material shortages, equipment bottlenecks or management policies) into consideration, thus creating a feasible plan.

Contact i2 Technologies, 1603 LBJ Freeway, Ste. 780, Dallas, TX 75234; (214) 620-0026.

Circle 397 on reader card

## Zinc Software Offers Application Framework V4.1

Zinc Software released version 4.1 of Zinc Application Framework, its C++ class library and visual development tool. Version 4.1 adds new objects, enhances existing objects, adds support for additional platforms, increases performance and improves product stability.

Zinc 4.1 allows software developers to create globally-enabled, object-oriented, cross-platform applications with one set of source code.

Enhancements include: a new IMAGE object, allowing the display of large bitmaps from native file formats; a new FILE object, allowing Zinc applications to read and write portable binary files on any operating system; CTL3D support for Windows, improving the look of Windows applications; an improved Help display, with ease-of-use enhancement and a facelift; support for dot-matrix printers in MS-DOS applications; easier function names, designed to reduce developer learning curves; improved performance; and improved stability.

Zinc Application Framework is licensed on per developer, per platform basis. Contact Zinc Software Inc., 405 South 100 East, Pleasant Grove, UT 84062; (801) 785-8900.

Circle 396 on reader card

## MaxTech Announces DOUBLEVISION 2.0

Maximum Computer Technologies Inc. (MaxTech) announced Release 2.0 of the DOUBLEVISION for Character Terminals, remote control software for UNIX systems. The company also announced the Maximum Advantage Program service/upgrade package for this product. DOUBLEVISION for Character Terminals allows a remote system to connect to another terminal (i.e., host terminal) and have full access to its screen and keyboard.

Once attached, the remote screen looks like the screen of the host terminal to which it is attached, and the remote keyboard is used to operate the host terminal over a serial I/O board, modem or network. The software is used to provide technical support, training, product demos and user productivity monitoring, all from remote locations. It also can facilitate network management activities and be used for collaborative computing.

Features include: TrueScreen improved screen tracking, which enhances DOUBLEVISION's ability to track the screen upon viewing; Instant Replay, which allows the

Now's the time  
to look at  
MiniSoft 92  
— the alternative.

STILL PAYING HIGH PRICES  
FOR TERMINAL EMULATION?

If the price of terminal emulation is still too high, then MiniSoft 92 is the alternative for HP and DEC connectivity. MiniSoft 92 gives you the power and versatility of the fastest growing terminal emulation and data communications package in the HP & DEC market. Among the many features are:

- Full HP 700/92 and DEC VT320 emulation
- Reliable high speed proprietary file transfer as well as FTP & Xmodem
- A powerful command language
- Full network and serial support

800/682-0200

MiniSoft Inc.  
312 Maple Ave.  
Snohomish WA 98290  
FAX 360/568-2923  
Ph. 800/682-0200

- Winsock compliant
- DDE & OLE support
- 32 bit architecture

MiniSoft 92 is the only HP terminal emulator that includes complete LAN connectivity in one integrated package. No additional PC software is required to make Ethernet, Token Ring or Arcnet connections.

MiniSoft comes bundled with its own TCP/IP stack, NS and Telnet virtual terminal protocols, allowing connections to HP, UNIX and DEC host computers across a majority of industry standard local area networks.

ONLY \$159

MiniSoft Marketing AG  
Papiermühle Weg 1  
CH-6048 Horw, Switzerland  
FAX 41.41.47 38 66  
Ph. 41.41.47 23 20

MINISOFT

MiniSoft92 is a registered trademark of MiniSoft Inc. All other trademarks are the property of their respective owners.

# UNIX

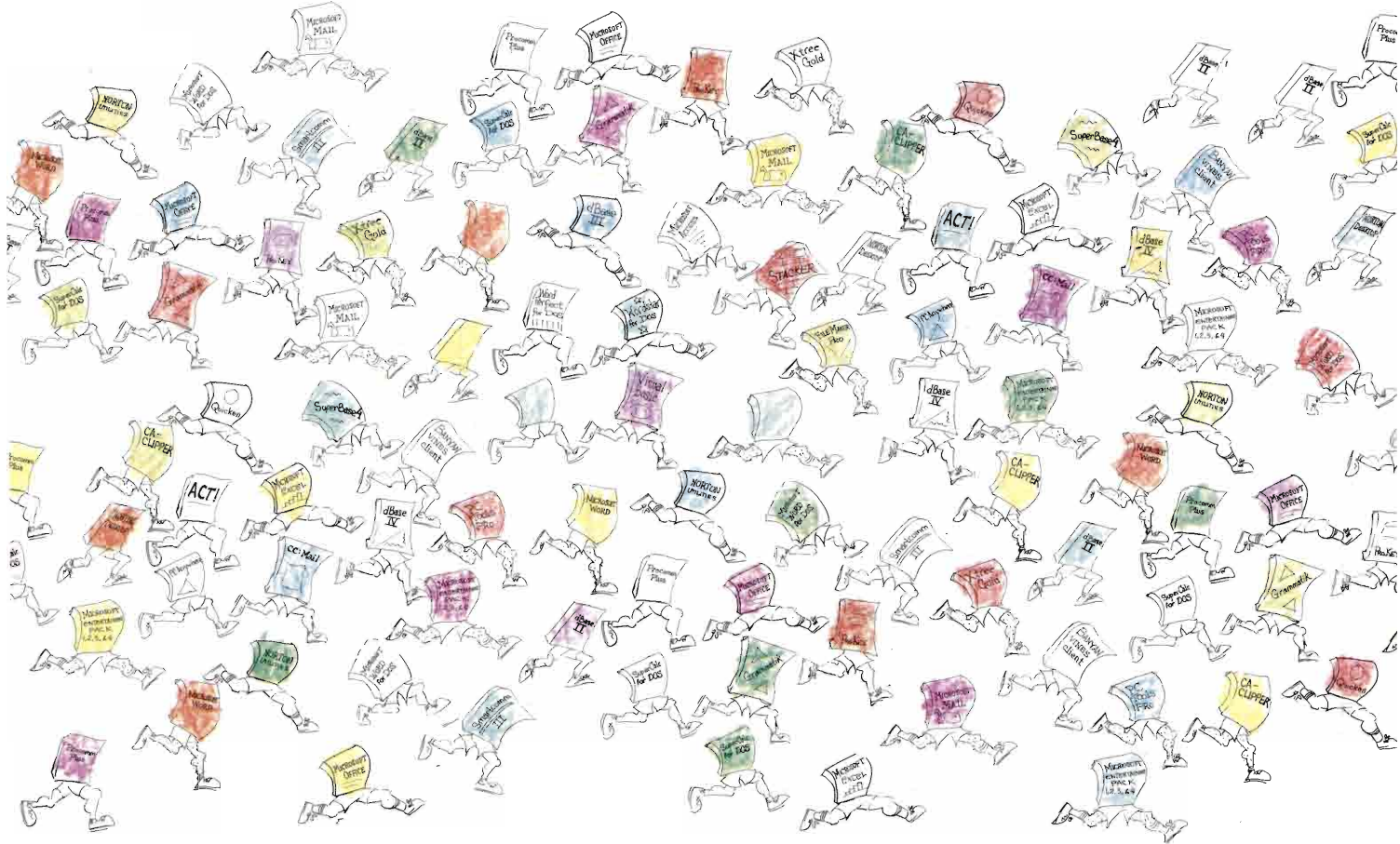

## All Your Favorite DOS & Windows Programs Running Under UNIX. What Could Be Better?

Imagine how productive you could be with thousands of great Windows and MS-DOS applications running on your UNIX workstation.

SoftWindows for UNIX helps you be more productive because you can run the same standard mode Windows

applications the rest of your company uses. From e-mail to databases, presentation packages to spreadsheets, you've got it all at your fingertips without leaving the UNIX environment. Or crowding your desk with two machines.

That means instant integration

with your corporate standard applications. Full use of PC networks and peripherals. And easy access to the applications and files that you need to stay on top of your work.

So call now for a FREE evaluation copy of SoftWindows for UNIX on HP, Sun, IBM, Digital, SGI, Motorola and Siemens Nixdorf platforms. Or, SoftPC for NEXTSTEP. And see how easy it is to get a stampede of Windows and MS-DOS applications running under UNIX. **Call 508-682-7600.**



**SoftWindows**™  
For UNIX

**INSIGNIA**  
SOLUTIONS

CIRCLE 218 ON READER CARD

Insignia Solutions, River Bend Business Park, 6 Campanelli Drive, Andover, MA 01810 • Phone: (508) 682-7600 • Fax: (508) 688-8294. In Europe, contact Insignia Solutions Limited, Phone: +44 494 459426 • Fax: +44 494 537817

© 1995, Insignia Solutions Inc., Mountain View, CA. Insignia and Insignia Solutions are registered trademarks of Insignia Solutions Inc. SoftWindows is a trademark used under license. Windows is a trademark and MS-DOS is a registered trademark of Microsoft Corporation. All other trademarks are the property of their respective holders.

remote user to play back a user-defined number of screens when viewing the host terminal; Screen Blanking, which allows the remote user to blank the host user's screen. This feature is useful when the remote user wants to perform functions they do not

want the host user to see; Chat Mode, which allows the host and remote user to converse on-screen; Activity Logging, which provides a complete log of the viewing session and provides data on the remote user; a date, time and duration

stamp; and also identifies the host terminal and user viewed; and revised user interface, which now includes pull-down menus and allows all default and command-line options to be set from the menu.

In addition, Release 2.0 of DOUBLEVISION has removed the restriction of one-to-one viewing, so that multiple users can now view the same terminal at the same time. Screen tracking and display functions have been separated in the new release, so that the display of the user's terminal can be sent to a computer other than where the user is logged in.

Release 2.0 also features improved recording capabilities that allow network administrators to schedule recording on one or more ports, and provides improved playback features with VCR-like commands.

DOUBLEVISION works seamlessly between disparate terminals, including proprietary terminals. A unique terminal-mapping capability adapts to each terminal environment automatically and handles screen reformatting on-the-fly.

Release 2.0 of DOUBLEVISION for Character Terminals is priced per machine beginning at \$395. Current DOUBLEVISION users can purchase the Release 2.0 upgrade beginning at \$99 per machine.

Contact MaxTech, 1000 Cobb Place Blvd., NW, Bldg. 200, Ste. 240, Kennewick, WA 98544; (404) 428-5000.

Circle 395 on reader card

### PageTech Releases Version 3.2 of HPEM

Page Technology Marketing Inc. (Page-Tech) released V3.2 of its HP PCL

# HERE'S YOUR SOLUTION!

*Quality products at affordable prices for*  
**HEWLETT-PACKARD/APOLLO®**

*Workstations,  
Peripherals and Upgrades*

- NEW and REFURBISHED
- Repairs
- 100% Customer Satisfaction
- Free Technical Support
- Immediate Delivery



## CMI

*Computer Marketing International, Inc.™*

**85 Flagship Drive**  
**No. Andover, MA 01845 USA**

**Tel: 800-497-4264**  
**508-687-3700**

**Fax: 508-689-2031**  
**Int'l. Fax: 508-687-4395**

CIRCLE 454 ON READER CARD

## SCRIPTSERVER NQM

*The definitive cross platform network printing solution*

See us at UNIX EXPO  
Booth #1816

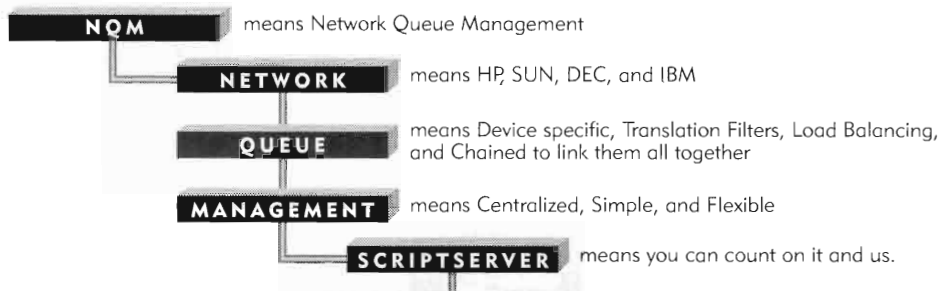

**SCRIPTSERVER NQM**  
Crossing platforms to solve  
your network printing problems.



**Free 30-day Demo**  
800 477-0348 Ext. 121  
or [info@graysoft.com](mailto:info@graysoft.com).



©Copyright 1995 GrayMatter Software Corporation. All rights reserved. Product and company names used are trademarks or trade names of their respective companies.

CIRCLE 132 ON READER CARD

(Advertisement)

## NEW \$1,000 2 GB SCSI-2 SUB-SYSTEM FOR HP-UX SYSTEMS

To introduce the new 9100 Series of Floppies, Hard Disks and Tape Storage Products for

HP-UX Systems, Texas ISA is offering a special introductory pricing on their new **high performance**

**2 GB** subsystem. It's **fast** with an average seek time of **9.5 ms**. More importantly, it's extremely **reliable** with an MTBF of 800,000 hours. That's why it's backed with a **five-year warranty**. But best of all, its compatibility with your HP 9000 Series 700/800 systems is **guaranteed!** Contact Texas ISA at (800) 361-2258, FAX (713) 493-2724.

Circle 403 On Reader Card

## INTELLIGENT HIGH SPEED DATA BUFFERS OFFLOAD HOST TO SAVE CPU CYCLES

Why not increase overall system performance by implementing ISA's HS-3900mkII Series Data Buffers into your environment? Designed specifically for high volume printing, these high speed and high capacity buffers can

be configured to operate in any environment. They can receive and output data via a

serial, parallel, or even an optional HP-IB port. For more details contact Texas ISA at (713) 493-9925, or (800) 361-2258

Circle 401 On Reader Card

## AUTOMATIC UNIX STARTUP/SHUTDOWN DEVICE PROVIDES SECURITY, SAVINGS AND CONVENIENCE

Texas ISA, Inc. announced the availability of its new Model 7030 with an Ethernet interface to allow the operation and control of networked UNIX system(s), with a single flick of a switch. The system power ON/OFF process can also be automated by the built-in timer, UPS Power Fail Signal, a shutdown request from the RS-232 or modem ports, and also by environmental triggers such as temperature and humidity. Additionally, alarms or preset messages can be sent to a pager. A Model 7020 (with no Ethernet interface) is also available. Prices for the Models 7020 and 7030 range from just under \$1,000 to \$2,500. Contact Texas ISA at (800) 361-2258. FAX (713) 493-2724.

Circle 402 On Reader Card

## NEW TOTOKU HIGH RESOLUTION, FULL-FEATURED COLOR MONITORS

If you are looking for a high-quality 17- or 21-inch color monitor, check out the new Totoku line of enticingly priced monitors from Texas ISA. Totoku has been an OEM for Sony and other vendors, and now introduces their very own models, the CV172U (17-inch priced at \$1,190) and CV211U (21-inch priced at



\$2,125). Texas ISA can be contacted at (800) 361-2258.

Circle 404 On Reader Card

### HP9122C HP9153C Replacements

# ISA Floppy Disk Family



**ISA 1015**  
(HP9122C Compatible)  
3.5-inch dual  
HP-IB SS/80

**ISA 1015S (NEW SCSI)**  
3.5-inch single  
(HP internal FD compatible)  
SCSI-for-HP 9000 300/400/  
700/800

**ISA 2055/2075**  
(HP9153C Compatible)  
118/270 MB with  
3.5-inch single  
HP-IB CS/80 SS/80

**ISA 1060S (NEW SCSI)**  
5.25-inch single  
SCSI-for-HP 9000 300/400/  
700/800

**ISA 1060**  
5.25-inch single  
HP-IB SS/80

• Memory • Floppy • Hard Disks • Optical • QIC • 8mm • 4mm DAT •

ISA, the Largest HP Enhancements Manufacturer



Texas ISA, Inc: Tel: 713-493-9925 Fax: 713-493-2724  
ISAHK CO., LTD: Tel: 852-2330-1977 Fax: 852-2330-1077  
EURISA SARL: Tel: 1-48-61-48-95 Fax: 1-48-61-49-06  
ISA CO., LTD: Tel: 03-3208-1150 Fax: 03-3208-1335

See us at INTEREX. Booth #1433.

CIRCLE 245 ON READER CARD



Emulator Program (HPEM) for tax form software developers and other HP PCL form overlay applications that limit output to only HP LaserJet printers. HPEM enables inkjet users to print HP PCL tax form overlays to their PCL3 printers, even in device independent environments, like Windows. The unique printer emulation, font scaling and printer driver technology found in HPEM is currently being used by PC users in products including Intuit/Chipsoft's TurboTax for DOS and TurboTax ProSeries, TenKey Publishing's Tax Shop and Money Magazine's TaxPrep. Licensing is customized to suit the needs of the developer.

HPEM supports over 600 printers and outputs to .pcx, .gif and .wmf file formats. It also provides a WYSIWYG preview of PCL5 with multizoom levels. The product is command line driven and can be called from within another program. HPEM prints to all printers using the resident scaleable and bitmap fonts normally found in an HP Series III LaserJet printer. The HPEM for Tax Forms version comes with resident "T" cartridge fonts. Contact PageTech, 12730 Carmel Country

Rd., Ste. 120, San Diego, CA 92130; (619) 755-5075.

Circle 394 on reader card

**WRQ Introduces Reflection SelectSuite**

WRQ announced Reflection SelectSuite, a universal client that is customized — customers choose exactly the Reflection connectivity products they need. The products are then delivered on a customized CD or set of disks. Reflection SelectSuite simplifies licensing and software management for large corporate sites.

Users are able to: create their own combination of connectivity products that will run on each workstation; select from the entire line of Reflection PC-to-host software for UNIX, DEC, HP, X and IBM systems (from Windows, DOS and Mac desktops), as well as the Reflection Network Series (TCP/IP with Internet, IPX/SPX NS/VT, LAT and NetBios); receive all products and upgrades on a single CD; manage software training and administration; and receive complimentary technical support.

Suite pricing is offered for any

combination of two or more products. Pricing varies depending on the retail price of each individual product and how many products are purchased.

Contact WRQ, 1500 Dexter Ave. N., Seattle, WA 98109; (206) 217-7500.

Circle 393 on reader card

**E-COMMS Inc. Integrates E-MANAGER Into HP OpenView**

E-COMMS Inc. announced the integration of its E-MANAGER GUI into HP OpenView for Windows. This adds environmental and facilities/wiring management to the HP OpenView for Windows platform, using the E-COMMS' E-COMMANDER system.

The E-COMMANDER system is a network addressable, SNMP-based remote monitoring and control system that allows a network administrator to cycle power (rebooting) to network devices at remote sites, monitor environmental variables like temperature, smoke, fire and moisture, and access and share network assets like modems and network analyzers. The E-COMMANDER is controlled by the E-MANAGER GUI at the administrators site.

**Hewlett - Packard / Apollo Workstations**

**300 ~ 400 ~ 700 ~ DN Series**  
call for availability

**New Axil Workstations!**

Tryonics is now an Axil Authorized Reseller. Axil workstations are Guaranteed 100% SPARC Compliant. All existing Solaris-based applications will run without any modification.

**WANT TO BUY**

<b>Hewlett-Packard</b>	<b>DEC</b>
~400, 700 & 800 Series	~DECstations
~Apollo/DN Series	~VAXstations
<b>SUN</b>	
~SPARC Series (4/60, 4/65, 4/370, 4/470, 4/670)	
~SPARC 1, 1+, 2, 3, 10, 20, 1000 and 2000	
~SPARC Classic, SLC, ELC, IPC, IPX and LX	
<b>Silicon Graphics</b>	<b>IBM</b>
~IRIS Indigo R4000 Series	~RS 6000
~Personal IRIS Series	~AS400
~Professional IRIS Series	~Power Stations
~Power Series	~Power Servers

**Tryonics**  
email:info@tryonics.com

**800-551-6236**  
Phone: 603-926-1122  
Fax: 603-926-0808

CIRCLE 477 ON READER CARD

RETHINK YOUR ASSUMPTIONS

**HP and Sun Service**

Are you sure your service plan is still right for you? Maybe you should rethink your service assumptions. Polaris has new, flexible, reliable alternatives for HP 9000 and Sun users that will make a difference.

We'll show you how to take better advantage of your resources, capitalize on new trends in computer service, and get a better return on your service investment. Think smart! Think Polaris. **800-541-5831**

**POLARIS**

The Leader in Independent UNIX Systems Service

ON SITE • SELF MAINTENANCE • TRAINING

CIRCLE 200 ON READER CARD



To protect your data,  
you could back-up hourly,  
buy a fire-proof safe,  
and a \$5 million  
insurance policy.



**Or not.**

**Your problem.** You need an industrial strength disaster recovery solution for your HP 3000 system. If disaster strikes or the system goes down, your job is literally on the line. But the last thing you want to do is make changes to your legacy applications. If only it were possible to replicate your complete application environments from one system to another.

In Europe, contact Orbit Software (tel: 44-1306-741741, fax: 44-1306-742742) or System Software International Ltd. (tel: 44-1905-794646, fax: 44-1905-794505).

**Our solution.** NetBase offers a comprehensive suite of networking functions for MPE, including network file access, spool management, disaster recovery, data shadowing, statistics, and remote program access. It allows a network of HP 3000s to operate as a single fault-tolerant machine, providing scalability, transparency, 24 hour uptime, and painless disaster recovery.

**NetBase<sup>®</sup>**

- ~ Creates a fault-tolerant network integrating MPE, UNIX and desktop systems.
- ~ Improves performance and maximizes system availability.
- ~ Optimizes workloads by distributing processes and data on the network.
- ~ Provides industrial strength disaster tolerance without the need to change applications.
- ~ Improves system management through file and user statistics for any node.
- ~ Protects investments by allowing modular growth.

At Quest Software, we offer a complete family of networking and output management products for the HP and Open Systems marketplace. So call us today, because potential disaster looms around every corner.

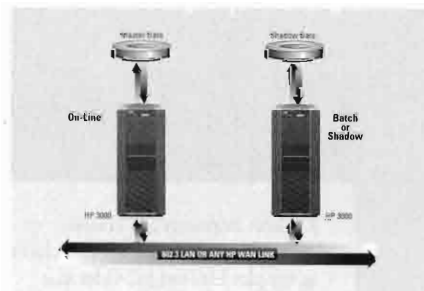

Quest Software - 610 Newport Center Dr.,  
Suite 1400, Newport Beach, CA 92660  
Phone: 714-720-1434, Fax: 714-720-0426,  
e-mail: [info@quests.com](mailto:info@quests.com).

All names are registered trademarks or trademarks of their owners.

**QUEST  
SOFTWARE**  
Expect a solution.

# WHICH UNIX SYSTEMS MANAGEMENT VENDOR HAS MORE THAN 4,000 COMPANIES APPLAUDING IN UNISON?

Unison Software, of course.

The reason for all the cheering is simple: Unison provides the proven, commercial-strength systems management software that companies need as they move to Unix and open systems.

With more than 4,000 customers worldwide, Unison's products address three of the most critical systems management functions: workload, storage, and output management. This includes things like job scheduling and workload distribution, system backup, and performance tuning.

Plus, Unison's software products have a fault-tolerant architecture that allows companies to safely automate the management of their business-critical applications. And Unison's products are fully integrated with the leading management frameworks, such as HP's OpenView and IBM's NetView, permitting customers to leverage their investments in those frameworks.

We could go on and on. About built-in security. Adherence to standards. Scalability. And much more.

But superior software is only part of the Unison story. Professional

services such as on-site consulting, implementation assistance, and 24-hour hotline support are a key factor in Unison's consistently high customer satisfaction ratings.

Give us a call today, and you'll begin to discover why Unison's software and services have earned a standing ovation.



Corporate Headquarters, 5101 Patrick Henry Drive, Santa Clara, CA 95054 408/988-2800

CIRCLE 139 ON READER CARD

The E-COMMANDER integrates with HP OpenView for Windows in three ways. E-COMMANDER systems are auto-discovered and represented by E-COMMANDER icons during map layout. When a network administrator clicks on the E-COMMANDER icon, the E-MANAGER application is opened, providing a front panel view of the E-COMMANDER rack. Finally, all traps generated by the E-COMMANDER are fully integrated into the HP OpenView Trap Manager.

The HP OpenView-integrated E-MANAGER GUI costs \$100. The single unit price for the E-COMMANDER Control Module includes the E-MANAGER plus the setup software, and costs \$3,500.

Contact E-COMMS Inc., 5720 144th St. NW, Gig Harbor, WA 98332; (206) 857-3399.

*Circle 392 on reader card*

### **Confluent Releases Visual Thought 1.2**

Confluent Inc. announced Visual Thought 1.2, a UNIX flowcharting and diagramming tool, for HP-UX, SunOS and Solaris.

Visual Thought moves ideas onto the screen quickly by making it easy for the user to drag-and-drop shapes and make rubberbanding connections between objects. The tool is used by engineers, software developers and technical professionals to draw flowcharts, software diagrams, process and block diagrams, network diagrams, organizational charts, circuit and logic diagrams and WWW graphics.

EPS and GIF file export capabilities allow Visual Thought to transfer diagrams to document processors like FrameMaker, Microsoft Word and WordPerfect, or to WWW pages.

Price is \$1,295 for a floating license and \$695 for a node-locked license.

Contact Confluent Inc., 132 Encline Ct., San Francisco, CA 94127; (415) 586-8700.

*Circle 391 on reader card*

### **Jobscope Offers DATACAP V2.0**

Jobscope Corp. introduced a new version of its bar code and Windows-based shop floor labor collection software.

New features of DATACAP V2.0 include a transaction editor, future absence entry, scrap function, as well as additional reporting functionality.

Labor collection is possible through WinCAP, a windows-based application, or through Intermecc hardware to use the ease of bar code recognition. The data is

interfaced to the Jobscope system providing accurate and up-to-date cost analysis that is necessary for success Job Shop environments.

Contact Jobscope Corp., 355 Woodruff Rd., Ste. 405, Greenville, SC 29607; (803) 458-3233.

*Circle 390 on reader card*

### **Xerox Announces DocuWeb**

Xerox Corp. announced DocuWeb, a hardware/software offering for the higher education market that will allow students to view and print specific digital documents via the WWW. Documents including course notes, reserved readings and out of print books can now be accessed electronically anytime, anywhere, via the Internet using any IBM-compatible PC, Mac or UNIX workstation.

Working directly with Xerox Documents on Demand System (XDOD), a solution that provides the interface to capture, store, edit, assemble and print customized documents, DocuWeb provides students with the ability to view and print documents residing on the school's XDOD library, via the institution's home page.

DocuWeb offers: the capability to view collections, which provides students an easier way to organize their data; thumbnail images, to examine multiple pages on a single screen; the ability to view XDOD-registered documents not in RDO format, such as Adobe Acrobat, text or PostScript files; and a GUI to guide users through the digital library layout.

Price is \$21,400.

Contact Xerox Corp., 295 Woodcliff Dr., 03A, Fairport, NY 14450; (716) 383-7948.

*Circle 389 on reader card*

### **Computer Associates Ships CA-OpenIngres 1.1**

Computer Associates shipped version 1.1 of CA-OpenIngres on all major UNIX platforms for mission-critical computing. The new version provides advances in performance, reliability and scalability while preserving client investments in data, applications and skills.

CA-OpenIngres 1.1 is available on AT&T GIS, DEC Alpha OpenVMS and VAX/VMS, Data General DG/UX, HP-UX, IBM AIX, ICL teamserver and super-server, SunOS and Solaris, and Novell UnixWare.

Enhancements include: performance and very large database (VLDB) improvements; improved client-server data access; SMP exploitation; spatial objects library; and

*21 users need data.  
That means  
printing 93,109  
pages of reports,  
assembling and  
delivering them by  
2 o'clock.*



**Or not.**

#### *VISTA Plus*

*VISTA Plus is the easy electronic report management solution that:*

- ~ Provides common access to MPE and UNIX reports without application changes.*
- ~ Users are up and running in no time.*
- ~ Full Windows functionality.*
- ~ Page content based security.*
- ~ Allows timely decision making with fast, efficient data access.*
- ~ Saves paper, resources and time.*
- ~ Integrates with spreadsheets, word processors and other PC applications.*

*Phone: 714-720-1434, e-mail: info@quests.com.*

*All names are registered trademarks or trademarks of their owners.*

**QUEST  
SOFTWARE**  
*Expect a solution.*

# NEWS RELEASE

For Immediate Release:

***Computer output management and enterprise print distribution just got a whole lot better.***

PLEASANTON, CA—JobRescue, ElectroPage and TranSpooler have undergone complete rewrites, using the latest in operating system functionality and software development technology to produce more efficient, reliable software.

JobRescue is sophisticated job management and error detection software for HP3000 batch processing. ElectroPage, a complementary product, is report management software for on-line viewing and print distribution. TranSpooler is a powerful spoolfile relocation program for manual or automatic transfer between MPE systems or between MPE and UNIX systems.

The v6.0 releases of JobRescue and ElectroPage are complete rewrites with many new enhancements. These enhancements include a new \$STDLIST/report viewer for MPE/iX with a much improved "foldering" strategy. This new strategy provides many new features, including easier-to-view reports, direct access to reports, and report download to PC capability.

Other enhancements include an event-driven background processor which results in more efficient resource use and more transparent operation. A menu-driven utility for both products replaces the OPTIONS file, making large editor files a thing of the past. The merge process has been eliminated, as files are aged in place and logically grouped for reporting purposes. This simplifies the file structure, history and processing.

Reports and \$STDLISTs may now be reliably archived using standard MPE utilities, such as Store/Restore, making retrieval simple. A new text indexing configuration allows you to access information very quickly, with no limit on the number of indexes defined. A new, standardized version control system—the What program—easily gives you version identification and build date/time. A new AutoDial program incorporates advanced error checking dialing capabilities for easier setup and full backward capability. The status program show and search functions have been enhanced to allow range searches.

The new, v2.0 release of TranSpooler also offers new enhancements for print distribution including more powerful UNIX compatibility. Also new is a user-friendly graphical interface for easy installation and configuration. TranSpooler provides direct printing from MPE/iX to JetDirect printers via TCP/IP to maximize system resources, as well as support for industry-standard protocols such as LPR/LPD and TFTP. Also new is a single threading feature that, when enabled, ensures original print order is maintained. TranSpooler now runs on HP3000 MPE/iX, HP-UX, SCO, AIX and Solaris.

The enhancements reflected in these new releases contribute to more powerful, reliable products that are easy to install, use and support. System resources and processing times are markedly reduced with these new products. Boost productivity and decrease operating costs with JobRescue, ElectroPage/3000 and TranSpooler.

Look to NSD for better ways to electronically manage, view, relocate and distribute your information. Call 1-800-538-3818 for more information on our products.

6602

OWENS DRIVE

SUITE 100

PLEASANTON

CALIFORNIA 94588

TEL 510.227.5600

FAX 510.225.1420

800.538.3818



#####

CIRCLE 256 ON READER CARD

SQL92 support and XA compliance .

Existing CA-OpenIngres clients under active maintenance can upgrade to version 1.1 at no charge. Pricing for new licenses varies by platform, starting at \$1,000.

Contact Computer Associates International Inc., One Computer Associates Plaza, Islandia, NY 11788; (516) 342-5224.

*Circle 388 on reader card*

**Illustra Ports DBMS To HP 9000s**

Illustra Information Technologies Inc. announced the availability of its object-relational DBMS to HP-UX, which is available on HP 9000 servers and workstations.

The Illustra object-relational DBMS extends the relational database model, enabling users to store, manage and analyze advanced information types such as audio, video and images in a single database with text and numbers, using industry-standard SQL. Illustra features DataBlade software modules that extend the database's ability to handle an infinite number of advanced information types.

It is available for Illustra Server and Illustra Developer's Kit for HP-UX version 9.x. Pricing for a five-user server license is \$6,250, with volume licensing less than \$900 per user. Illustra's Developer's Kit is priced at \$495 each.

Contact Illustra Information Technologies Inc., 1111 Broadway, Ste., 2000, Oakland, CA 94607; (510) 652-8000.

*Circle 387 on reader card*

**Open Horizon Inc. Launches Connection**

Open Horizon Inc. announced Connection, a standards-based connectivity product to provide IS organizations with the means to transparently link any application with heterogeneous databases and enterprise services.

Connection gives businesses a simple, cost-effective path from departmental to enterprisewide client-server computing — while allowing them to leverage their existing investments in technologies and systems.

Connection leverages standards like ODBC and leading database APIs to provide a foundation for open access to relational and nonrelational data sources.

Additionally, Connection's modular connectivity foundation provides organizations with the ability to progressively "snap-on" business-critical enterprise services such as user authentication, data encryption, central administration, directory

services and transaction processing as business requirements evolve.

Contact Open Horizon Inc., 1301 Shoreway Rd., Ste. 126, Belmont, CA 94002; (415) 598-1200.

*Circle 385 on reader card*

**Boole & Babbage Extends HP OpenView**

Boole & Babbage announced that it has advanced its partnership with HP by entering into an agreement to provide enhanced interoperability between Boole & Babbage products and HP OpenView OperationsCenter and HP-UX.

The results of the work already completed are: Ensign integration with HP OpenView Network Node Manager (NNM) to the level of HP OpenView Premier Solution Partner; Boole & Babbage Ensign support for HP-UX; and bi-directional interoperability between Boole & Babbage COMMAND/Post and HP OpenView NNM.

Boole & Babbage will provide automation and alert integration between COMMAND/Post and HP's OperationsCenter as well as HP-UX support for COMMAND/Post. Additionally, the agreement expands the existing implementation of bi-directional interoperability between COMMAND/Post and HP OpenView NNM, including applications launching, alert sharing and map integration.

COMMAND/Post is an enterprisewide automated systems management product that provides central point-of-control for availability, fault management and automated operation of complex, multivendor environments. COMMAND/Post can alert the IS manager to problems and respond automatically to any systems and network events to fend off trouble conditions.

Contact Boole & Babbage, 3131 Zanker Rd., San Jose, CA 95134; (408) 526-3000.

*Circle 384 on reader card*

**Inclination Software Announces SpeedBase**

Inclination Software announced the availability of SpeedBase, a new database subsystem for UNIX- and MPE/iX-based computer systems.

The SpeedBase package offers features such as sorted key chains, multiple keys, easy import of existing data files as well as a powerful query utility, a flexible scripting language and essential subroutine calls for languages such as C, C++, Fortran and COBOL. Program development time is reduced by simpler program calls, predefined filters, data links and output



*To use NFS, you could dump all your HP 3000s, set up a new network, and retrain all your MIS staff.*



**Or not.**

**NFS/iX**

*NFS/iX is a high-performance implementation of NFS for the HP 3000 that:*

- ~ Provides industry-standard, transparent interoperability on heterogeneous networks.*
- ~ Eliminates lengthy, time-consuming file transfers.*
- ~ Lets the HP 3000 operate as a high-performance file server.*
- ~ Allows centralized management of diskless clients for improved security and backups.*
- ~ Facilitates workgroup development and client/server deployment.*

Phone: 714-720-1434, e-mail: info@quests.com.  
All names are registered trademarks or trademarks of their owners.

**QUEST SOFTWARE**  
*Expect a solution.*



**SEQUELINK.**

**“WITHOUT IT,  
I’D SPEND ALL  
MY TIME JUGGLING  
DATABASE  
CONNECTIONS.”**

SequeLink database middleware provides a single high-performance connection to all of your databases. Now you don't have to juggle SQL\*Net, Open Client, I-Net, various ODBC drivers, and other database connectivity “standards.”

**ANY USER** SequeLink connects to any client – from Macintosh to Unix. Choose direct interfaces to applications such as Excel. Or a uniform ODBC driver that connects to multiple databases simultaneously. Or our API for C/C++ and Visual Basic programmers.

**ANY NETWORK** SequeLink even uses your existing network, including NetWare, NetBios, NetBeui, TCP/IP, APPC, Appletalk and DECnet.

**ANY DATABASE, ANY PLATFORM** Oracle. SQL Server. Informix. Ingres. DB2. AS/400. Rdb. On Unix. OS/2. Windows NT. MVS. VM. VSE. And VAX/VMS servers. Got another one? We can probably support it.

**SEE THE MAGIC AT OUR FREE SEMINAR**

You'll learn how to supercharge your client/server applications without dropping the ball.

**TECHGNOSIS**

**IT’S NOT JUST  
MIDDLEWARE.  
IT’S EVERYWARE.**

SEE SEQUELINK AT OUR  
FREE “IT’S NOT JUST  
MIDDLEWARE” SEMINARS.  
800-610-7337

formats. Implementation of SpeedBase can be started as a local database and switched to a full distributed client-server application with no programming changes whatsoever.

The SpeedBase/Query (SBQ) utility is self configuring depending on if the user runs it on an ordinary ASCII terminal or a UNIX workstation. On a workstation running X Windows/Motif, SBQ has a full GUI interface, supporting menus, dialog boxes, mouse and a scrollable output capture window. The output capture window allows the user to preview the results of their query before deciding on if or what to print. Because the window is scrollable, the user can view any portion of the output without the need for hard copy.

SpeedBase is initially available on the HP 3000 systems running MPE/iX 4.5 or later, or the HP 9000 running HP-UX 8.0 or later, as well as Sun SPARC systems running SunOS, Solaris 2.4 or later or Intel systems running Solaris86 2.4 or later.

SpeedBase is licensed for \$250 per user or \$2,500 per system, whichever is less. There are no additional charges for the query utility, client-server capability or the scripting language.

Contact Inclination Software Inc., P.O. Box 8668, Incline Village, NV 89452; (702) 831-5595.

*Circle 383 on reader card*

### **Adra Systems Inc. Extends PDM**

Adra Systems Inc. announced enhancements to help users implement business process re-engineering with a new version of its Matrix System software, a new API, new service programs and more than a dozen new partners. The new Matrix product and programs enable users to go beyond simple product data management (PDM), and start using their organizational resources to achieve effective business process re-engineering.

Matrix System integrates complex data management, workflow and communications through an easy-to-use GUI.

The key elements include: Matrix 3.0, an enhanced version of Adra's PDM solution; Matrix API, a new API designed to provide developers and integrators with a standard easy-to-use way to develop applications for Matrix; expanded RapidStart Program, which includes several new levels of service; new reseller partners; and new Matrix software developers and implementation partners.

Prices start at \$35,000 for the initial 20-user license. Additional user licenses are priced at \$1,200 each. RapidStart support

and implementation programs start at \$15,000. Matrix supports AIX, Digital UNIX, HP-UX, Irix, Solaris, SunOS, Microsoft Windows version 3.1.1, Windows NT and Windows 95.

Contact Adra Systems Inc., Two Executive Dr., Chelmsford, MA 01824; (508) 937-3700.

*Circle 382 on reader card*

### **HARDWARE**

#### **EM Inc. Offers 8505XL Products**

IEM Inc. introduced a complete line of 8mm tape products, using the new Exabyte 8505XL tape drive mechanism. IEM's products include standalone drives, 10-tape autofeeder and 20- or 40-tape carousels. The new drive mechanism offers high capacity, improved transfer rates and a higher MTBF.

IEM's SCSI and HP-IB 8mm tape drives can store up to 7 GB of uncompressed data and 14 GB of compressed data on a single tape (with a 2:1 compression ratio). IEM's 8mm tape drives are available with IEM's 8mm tape controller which allows users to use HP's standard DAT device drivers. IEM's controller also optimizes buffering to achieve a higher typical transfer rate than with other manufacturers' 8mm tape devices.

The standalone drives also are available as expansion kits for IEM's SCSI Tower Case or building blocks for IEM's Building Block product line.

The autofeeder uses the Exabyte EXB-10h intelligent autofeeder mechanism in combination with the 8505XL tape drive. These units support sequential and random access. There is also an autofeeder which includes IEM's 8mm tape controller, and allows HP's standard DAT device drivers to be used.

IEM's 20- and 40-tape carousel libraries are available with one to four 8505XL 8mm tape drives installed.

Each tape in an 8505XL tape drive can hold from 7 GB (uncompressed) to 14 GB (with a 2:1 compression ratio) of information. These drives offer a 1 MBps transfer rate, and a 160,000 POH MTBF.

Contact IEM Inc., 1629 Blue Spruce Dr., Fort Collins, CO 80524; (970) 221-3005.

*Circle 381 on reader card*

#### **ICS Electronics Produces Model VXI-5543E**

ICS Electronics announced a new VXI Slot 0 Controller and Embedded Computer with the capability to control VXI systems over a network. The Model VXI-5543E

*To share printers,  
you could do  
complex spooling  
and spend a  
fortune on  
implementation  
and training.*



**Or not.**

#### **NBSpool**

*NBSpool is a high-performance HP 3000 print spool management solution that:*

- ~ Empowers your users to select the right printer for the right job.*
- ~ Provides transparent printer connectivity across MPE, Windows NT, UNIX, IBM, VAX, NetWare, LAN Manager, Banyan Vines and more.*
- ~ Eliminates lost reports and facilitates information routing.*
- ~ Provides an intuitive user interface that accelerates implementation and lowers training costs.*

*Phone: 714-720-1434, e-mail: info@quests.com.*

All names are registered trademarks or trademarks of their owners.

**QUEST  
SOFTWARE**  
*Expect a solution.*

# Four of the top trading houses on Wall Street use MOUSE-TRAK.

*Productivity and reliability persuaded these businesses to replace hundreds of free mice that came with their workstations with \$199 MOUSE-TRAK™ trackballs.*

**Productivity:** Laboratory testing has shown that only 4 hours of continuous mouse usage can result in as much as 60% loss of hand strength. A trader in that condition is simply not going to make as many trades per hour in the second half of the day as in the first. The same tests show no signs of physical fatigue when using a MOUSE-TRAK.

**Reliability:** MOUSE-TRAK's rugged construction results in *much* higher reliability than mice or consumer trackballs. MOUSE-TRAK doesn't take traders out of play or make support people pull their hair out!

*Call today to order or receive a copy of our analysis of the benefits of a MOUSE-TRAK versus a free mouse.*

1-800-533-4822  
sales@moustrak.com

**mouse-trak**

The Professional's Trackball



**ITAC Systems, Inc.**

MOUSE-TRAK is manufactured in the U.S.A. by ITAC Systems, Inc., 3113 Benton Street, Garland, Texas 75042 Fax: 214/494-4159. Patented by ITAC Systems, Inc.  
MOUSE-TRAK is a registered trademark of ITAC Systems, Inc. Other brand and product names are trademarks of their respective holders.

## new products

features an Ethernet interface and firmware for direct connection to an Ethernet network using TCP/IP or VXI-11 protocols. The VXI-5543E provides an alternative means for intelligent control of remote VXI chassis via a network.

The VXI-5543E is a completely embedded AT style computer with software that allows it to operate in a variety of configurations. AT power turn-on, the VXI-5543E runs its resource manager program and then is ready to execute commands received via its Ethernet, GPIB or serial ports. Alternately, the VXI-5544E can execute programs stored on its solid-state drive or download programs from a remote host computer. Test data can be sent back to the remote host via the network connection.

The VXI-5543E's Ethernet interface is a standard IEEE 802.3 compatible 15-pin AUI connector with extra 10Base-T signals. External transceivers can be used to adapt the VXI-5543E to a 10Base-2 coaxial system. It includes a LAN Control program that allows it to execute commands received from the network and drivers for operation with TCP/IP, ODI and NDIS network protocols. The LAN Control program operates with VXI-5 compatible commands and the new VXI-11 Specification for VXI TCP/IP Instrument Protocol.

The VXI-5543E is a single slot wide, C-size module that has been optimized for remote control of VXI, GPIB and Serial instruments.

It is available with 1 or 2 MB of disk storage and includes the LAN Control program and network drivers. Price starts at \$3,660.

Contact ICS Electronics Corp., 473 Los Coches St., Milpitas, CA 95035; (408) 263-5500.

Circle 380 on reader card

## Andromeda Systems Offers Caching LUN Translator

Andromeda Systems Inc. introduced a SCSI bus address expander with optional cache.

The caching LUN Translator is contained in a half-height, 5.25-inch chassis, installed in the SCSI bus and allows up to seven devices to be connected to a single SCSI target ID. With seven LUN Translators installed in a system, the number of addressable SCSI devices is increased from seven to 49. Typical applications for the LUN Translator are large law firms, court houses, research libraries, research facilities, medical institutions, newspapers, schools and universities where vast amounts of data have to be online.

CIRCLE 138 ON READER CARD



With the cache option installed, applications for the LUN Translator are CD-ROM disk farms, optical disk farms, jukeboxes, Winchester disk farms, installing it behind RAID 0 and 1 controllers or in front of the drives that are attached to a RAID 3 and 5 controller.

Price for the LUN Translator (without cache) is \$1,595. Cache versions start at \$2,250.

Contact Andromeda Systems Inc., 9000 Eton Ave., Canoga Park, CA 91304; (818) 709-7600.

Circle 379 on reader card

### Proteon Produces p8900 Switch

Proteon Inc. announced 100BaseVG-AnyLAN and 100Base-T (Fast Ethernet) options for its 16-port Series 80 p8900 Ethernet Switching Hub. The p8900, which is already available with an FDDI option, will provide users with multiple high-speed interface choices.

With the addition of the 100BaseVG-AnyLAN and 100Base-T high speed interface modules, there are now three LAN options that can be installed in the p8900 switch. All three options can be installed in any combination.

The p8900 is part of Proteon's Pro-NET/E family of Ethernet products that includes a suite of PC network adapters, intelligent hubs and switching hubs.

The p8920-HA is a single port 100-BaseVG-AnyLAN interface module for the p8900 switch. Price is \$2,995. Proteon's 100Base-Tx interface module, the p8930-HA, is also a single port device that operates at 10 times the speed of standard Ethernet. Price is \$2,995.

The p8900 is a scaleable switch that can be managed in a variety of ways. Each switch comes with an SNMP agent that includes standards-compliant Ethernet, bridging and MIB extensions. It can be managed locally through a console port or remotely through Telnet.

Contact Proteon Inc., Nine Technology Dr., Westborough, MA 01581; (508) 898-2800.

Circle 378 on reader card

### U.S. Robotics Releases I-Modem

U. S. Robotics announced its entry into the ISDN market with Courier I-Modem with ISDN/V.34.

An ISDN terminal adapter with an integrated V.34 modem, the Courier I-Modem eases the transition from analog to ISDN, allowing users to take advantage of

ISDN's higher bandwidth without sacrificing analog data and fax capabilities.

Because I-Modem also includes U.S. Robotics' Courier "V.Everything" capabilities, for compatibility with the installed base of V.34, V.FC, V.32 turbo and slower speed modems, the product provides access to analog-based online services; Group III fax devices; individual modem users; home banking services; and workplaces or Internet service providers that have not yet begun deploying ISDN services.

The Courier I-Modem connects to BRI (Basic Rate Interface) ISDN services. BRI includes two "B channels," which have a bandwidth of 64 Kbps each. It also includes one 16 Kbps "D channel," primarily used for signaling information and call setup. On the analog side, the product's features will be identical to the company's Courier V.Everything with V.34 products.

Prices range from \$595 to \$895.

Contact U.S. Robotics Inc., 8100 N. McCormick Blvd., Skokie, IL 60076; (708) 982-5010.

Circle 377 on reader card

### Exabyte, HP Provides EXB-218 4mm Tape Library

Exabyte Corp. and HP plan to provide 4mm storage automation for large PC networks and mid-sized UNIX networks. The Exabyte EXB-218 4mm Tape Library combines HP's DDS-2 4mm digital audio tape (DAT) drives along with Exabyte's tape library design, robotics and mechanisms.

The EXB-218 combines two tape drives with robotics and up to 19 4mm data cartridges in a compact, secure enclosure. For end users operating in multiserver network environments who prefer 4mm technology, the EXB-218 is ideal for automating all facets of data storage management. High capacity of 152 GB and an overall throughput rate of 120 MB per minute, or 55 GB in an eight-hour time-frame, meets the requirements of demanding backup and restore applications. In addition, the EXB-218 is designed to work with software (sold separately) developed by leading software vendors such as Arcada, Cheyenne, Legato, Palindrome and others.

Incorporated in the EXB-218 is the HP C1533A DDS-2 DAT drive. With compression, the drive provides 8 GB of storage capacity and a transfer rate of over 1 Mbps.

The design, robotics and many of the mechanisms of the EXB-218 are the same as those found in Exabyte's 8mm automated storage devices. In addition to the HP C1533A 4mm DAT drives, the EXB-218 is packaged with high-quality EXATAPE

*You could shop  
around endlessly  
to solve all your  
networking  
and output  
management  
needs.*



**Or not.**

#### Quest Product Family

*Our complete family of HP networking and output management solutions means one-stop shopping:*

- ~ VISTA Plus, the easy-to-use electronic report management solution.
- ~ NBSpool, the high-performance spool management solution.
- ~ NFS/iX (Client and Server), the only NFS for MPE XL and POSIX.
- ~ NetBase, the comprehensive clustering and disaster recovery solution.
- ~ NetBase Client, straightforward access to MPE data from UNIX and LANs.
- ~ EnterPrint™, a robust and scaleable server for Xerox production printers on TCP/IP networks.
- ~ QUARK Plus, the multi-platform compression solution.



Phone: 714-720-1434, e-mail: info@quests.com.

All names are registered trademarks or trademarks of their owners.

**QUEST  
SOFTWARE**  
*Expect a solution.*

CIRCLE 268 ON READER CARD

DDS-2 DAT data cartridges, an EXATAPE cleaning cartridge, a SCSI cable and an owner's manual. Cost is \$8,000.

Contact Exabyte, 1685 38th St., Boulder, CO 80301; (303) 417-7872.

*Circle 376 on reader card*

### **Andataco Introduces RAID Lite**

Andataco announced the availability of RAID Lite, the first of a new generation of RAID arrays powerful enough to service the I/O demands of large network servers, yet affordable to small UNIX network and power desktop users. Incorporating a powerful RISC CPU and up to 32 MB of read/write cache memory, RAID Lite provides quick response time for transaction intensive database applications. For applications that require high data transfer rates and massive capacities, RAID Lite features up to five 20 MBps Fast Wide SCSI processors supporting up to 35 drives for a total capacity of 150.5 GB. RAID Lite also is designed for flexibility with support for desktop, deskside and rackmount enclosures, as well as support for RAID levels 0, 1, 5 and 6.

RAID Lite is backed by powerful, but user-friendly, system management software and a full suite of services. Every RAID Lite system includes a RAID Management Utility called RMU Lite which features a client-server architecture for remote monitoring and control across a network, a GUI supporting simple point, click and drag operations.

Key RAID Lite features and benefits: capacity ranging from 2.1 GB to 150.5 GB; modular desktop, deskside and rackmount enclosures for environments ranging from desktop to data center; RAID levels 0, 1, 5 and 6 to suit the specific needs of a variety of applications; advanced 32-bit version of industry standard SCSI processors support Fast Wide SCSI interface and disk drives; up to 32 MB of standard SIMM cache memory provides lightning quick response to read and write requests; redundant load sharing power supplies ensure a source of continuous power; battery backup protects data in cache during power or system failures; automatic rebuild of hot spare disk drives enable RAID Lite to repair itself; user definable rebuild priority to suit your specific need for fault tolerance versus I/O performance; user

replaceable disk modules and power supplies enable self maintenance; FWSE or FWD SCSI host ports for wide connectivity across UNIX platforms; three user interfaces (front panel, controller-based monitor utility and host-based RMU Lite software) provide the right RAID management tools for the operator, service engineer and data center manager; and point, click and drag client-server RAID Management Utility, RMU Lite, for remote monitoring and control across the network.

RAID Lite is priced from \$4,995 for a desktop system with two 1.0 GB drives up to \$150,000 for a data center system with 35 4.3 GB drives.

Contact Andataco, 10140 Mesa Rim Rd., San Diego, CA 92121; (619) 453-9191.

*Circle 375 on reader card*

### **Hand Held Products Announces RF LITE**

Hand Held Products (HHP) announced RF LITE, wireless terminals and RF Simplicity, the Visual Basic developers tool for application development.

RF LITE is available in contact and non-contact portable terminals. The

## **Make the UNIX to MPE Connection**

# **IX/92™**

**Full featured HP terminal emulation**

**New! Version 6**

**Faster File Transfer  
NS/VT Network Option  
Enhanced Script Language**

**Available for:**

**HP-UX    Interactive UNIX    SCO UNIX    SunOS/Solaris**

Software Licensing Corp., Suite 280, 930 Tahoe Blvd. Unit #802  
Incline Village, NV 89451-9436

Phone: (800) 831-0882 or (702) 832-0881 Fax: (702) 832-0883

All trademarks are the property of their respective holders.

**CIRCLE 123 ON READER CARD**

## **THE TOTAL SOLUTION**

*sales, service, support*

- ◀ On-time service, on-line equipment.
  - Black River takes the risk and worry out of ordering, implementation and maintenance.
  - You're assured:
    - Full line of new and previously owned, refurbished 9000, 3000 and 1000.
    - Technically trained maintenance team.
    - Free installation
    - Nationwide service.
- Call 216-365-9950 or fax 216-365-3916 for more information.

**BLACK RIVER**  
COMPUTERS

**THE TOTAL SOLUTION**  
*sales, service, support*

7630 RACE ROAD • NORTH RIDGEVILLE, OHIO 44039  
216-365-9950

**CIRCLE 171 ON READER CARD**

# Reader Information

## **AURORA TECHNOLOGIES CIRCLE 181**

Aurora Technologies introduces Node-Resident Networking, a cost-effective, high-performance alternative to standalone routers and terminal servers. Aurora data-communications solutions make it easy to add and share modems, printers, terminals and other peripherals for entire workgroups. Aurora's WAN and remote access products connect LANs across the globe. Call (617) 290-4800, FAX (617) 290-4844.

## **COMPUTER MARKETING INTERNATIONAL INC. CIRCLE 454**

Independent distributor of new and refurbished HP Apollo workstations and peripherals. We provide in-house technical support and depot repair services. We are committed to providing 100% customer satisfaction on every order. Call 800-497-4CMI.

## **CONCORDE TECHNOLOGIES CIRCLE 232**

Concorde Technologies, Inc., "The Hewlett-Packard Experts" is an HP Channel Partner and Value Added Reseller of HP and third-party products for the HP 9000. Concorde's line of products includes HP 9000 systems, application software, CD-ROM solutions, RAM memory, mass storage peripherals and accessories. For the best prices, availability, warranty and support, Concorde Technologies. Call (800) 359-0282.

## **DATASTRUCTURE, INC. CIRCLE 231**

Datastructure's DB/Access provides online data warehousing and selective offline archiving and restoring for the HP 3000 without scripting or programming. DB/Access automatically builds and/or links database and file targets in one pass. DB/Access selectively reorders, extracts, transfers, deletes and restores data between IMAGE, KSAM, flatfiles and tape.

With unlimited value selection, DB/Access generates meaningful test data; capacities are set at the screen. Omnindex and Superdex integration provide fast data retrieval. Delimited files can be used for cross-platform downloading. Call (415) 495-7484.

## **IEM CO. CIRCLE 122**

IEM offers affordable solutions for the HP environment, including 4mm and 8mm tape drives, autofeeders and carousels, QIC tape drives, optical drives, fixed Winchester drives, floppy disk drives and combination drives. IEM's new Building Block product line is a modular storage solution into which you can slide a number of different disk, tape and optical units. IEM offers an automated backup and archival software solution. Most IEM products are available with

an HP-IB or SCSI interface for HP 1000, 3000 and 9000 computers.

Call (970) 221-3005 or (800) 321-4671, or send E-mail to [info@iem.com](mailto:info@iem.com).

## **INFORMATION BUILDERS INC. CIRCLE 247**

Information Builders provides FOCUS, the world's most widely used 4GL, and EDA/SQL, the number one rated middleware solution. Available on HP-UX, MPE/iX and 35 other platforms. FOCUS is used for application development and decision support. EDA/SQL is used for data access, warehousing, migration and much more. Call (800) 969-INFO.

## **KINGSTON TECHNOLOGY CORP. CIRCLE 281**

Kingston Technology designs and manufactures memory upgrades for PCs, laptops, workstations and laser printers. The Kingston product line also features mass storage subsystems and processor upgrades.

Call (800) 835-2545, FAX (714) 435-2699.

## **M.B. FOSTER ASSOCIATES LTD. CIRCLE 155**

DataExpress, the #1 End-User Computing Environment and report writer. EDI Windows, translation software. Reflection and the Network Series. Call (800) ANSWERS, FAX (613) 448-2588.

## **MINISOFT INC. CIRCLE 472**

Minisoft 92 for DOS and Windows providing HP terminal emulation and LAN connectivity for just \$159. Call (800) 682-0200.

## **NEWPORT DIGITAL CORP. CIRCLE 246**

Accelerator cards for HP 9000 Series 200 plus HP 310 and HP 320. Ten-fold performance improvement. Call (714) 730-3644.

## **OMTOOL CIRCLE 130**

Omtool's Fax Sr. is the versatile network fax software based on client-server architecture. Clients are available for Windows, DOS, Macintosh, Windows NT and Motif with server options including Windows NT and HP-UX. Call (603) 898-8900.

## **QUEST SOFTWARE CIRCLE 268**

The only complete HP 3000 solution for:

- 1) High speed network file and database access.
- 2) IMAGE, KSAM and MPE file shadowing.
- 3) Low overhead and network spooling.

Call (714) 720-1434.

## **TEXAS ISA INC. CIRCLE 245**

HP-IB and SCSI Tape and Disk Storage • Data Buffers • Power Management Solutions for UNIX and non-UNIX Platforms

Manufacturers of storage solutions for HP environment for fifteen years. With our unique new line of Intelligent Automatic Startup and Shutdown devices, companies can now control the AC power ON/OFF schedules of local and remote UNIX systems. The ISA 7030, for instance, can warn of abnormal environmental conditions (temperature, vibration, humidity, and smoke), and perform graceful shutdowns and startups. These new devices can significantly enhance system and data security, save time, energy, and equipment costs. They also tremendously increase the convenience of managing local and remote systems.

Call (713) 493-9925 or (800) 361-2258 for additional information on any of our high quality products.

## **TECHNOSIS, INC. CIRCLE 151**

TechGnosis has developed a unique client-server computing architecture known as "SEQUELINK" Client/Server MiddleWare. This database middleware software uses your existing network connections to provide access from any client to any database on any platform. SequeLink replaces the individual connectivity solutions provided by the database vendor with a single connectivity solution. Call (617) 229-6100.

## **UNISON SOFTWARE INC. CIRCLE 499**

Unison-Tymblabs is a supplier of networked systems management solutions for both UNIX and MPE. Product areas include workload management, storage management, print automation and desktop integration. Call (408) 245-3000.

## **WRO (WALKER RICHER & QUINN) CIRCLE 263**

Makers of Reflection Series Software. HP terminal emulation for PCs and Macintoshes. Call (800) 872-2829.

## **WESTERN SCIENTIFIC MARKETING INC. CIRCLE 480**

Western Scientific offers a line of high-performance peripherals to upgrade and enhance your Sun, HP, Silicon Graphics, DEC, IBM RS/6000 and Novell workstations. We configure, integrate and test innovative disk, tape optical, RAID, jukebox and memory subsystems to meet your application requirements. Call (800) 443-6699.

PASS THE WORD — SAY YOU SAW IT IN HP PROFESSIONAL

Micro-Wand RF LITE integrates a contact scanner, microprocessor, full alphanumeric keypad, 4x20 character display, battery and RF transceiver into one 10 oz. design.

The Laser-Wand, HHP's integrated non-contact portable terminal, combines similar features into a 24 oz. non-contact terminal with an eight-line display.

The RF transceiver can be added either the Micro-Wand or Laser-Wand. The Micro-Wand transceiver snaps securely on the end of existing Micro-Wand III E or

32ES for field upgrades, or can be bought with a Micro-Wand as a unit.

RF Simplicity allows programmers to use the Visual Basic developers kits for simple wireless applications and real time communications.

RF LITE systems start at \$2,995, with additional terminals costing \$1,290.

Contact Hand Held Products, 7510 E. Independence Blvd., Ste. 100, Charlotte, NC 28227; (704) 537-1444.

Circle 374 on reader card

## HP Provides Inkjets For The Office

HP introduced the HP DeskJet 1600C and 1600CM workgroup printers.

The DeskJet 1600C and 1600CM use the same processor that is used in the HP LaserJet 4 Plus printer — the Intel 32-bit RISC 18096KB. The printer's first-page-out speed is rated at 13 seconds for black printing.

The DeskJet 1600C and 1600CM printers feature four separate ink cartridges — black, cyan, magenta and yellow — with integrated print heads.

The DeskJet 1600CM printer comes with a JetDirect print-server card for Ethernet and LocalTalk networks. The DeskJet 1600C printer also can be connected to virtually any network by adding an optional JetDirect card.

Both printers are equipped with a high-speed HP Bi-Tronics parallel interface that provides bi-directional communications and data transfer rates of up to 200 Kbps for faster printing from a PC.

The DeskJet 1600C printer is equipped with enhanced HP PCL 5 with color for LaserJet printer compatibility with most DOS and Windows applications. For compatibility with Mac and mixed environments, the DeskJet 1600CM printer also includes Adobe PostScript Level 2 and automatic language switching.

Both printers are equipped with HP's Memory Enhancement technology (MEt) which doubles standard printer memory and allows more complex graphics to print without adding memory. The DeskJet 1600C printer comes standard with 4 MB of memory, expandable to 100 MB. The DeskJet 1600CM printer comes with 6 MB of memory, expandable to 70 MB.

The DeskJet 1600C printer costs \$1,399, and the DeskJet 1600CM printer costs \$1,999.

## Imperial Technology Delivers MegaRam-3000

Imperial Technology introduced MegaRam-3000, a new member of the MegaRam family of solid-state disks. The MegaRam-3000 features SCSI-2 Fast and Wide interfaces with a transfer rate of 20 MBps per port, an access time of only .035 ms and a capacity of 67 MB to 3.018 GB.

The MegaRam-3000 comes standard with dual NiCad battery packs, an interface that can be switched from a single-ended to differential with a simple jumper. Built in diagnostics constantly patrol in the background, even checking the condition

*Thanks to Harmonizer, over 1400 Aldon customers are humming a new tune about installing new packaged software releases.*

# A classic from the Aldon repertoire. Harmonizer.

Harmonizer allows you to make modifications to your software applications and still take advantage of new releases.

In fact, Harmonizer can save you 60-80% of the time you now spend putting up new releases.

Harmonizer identifies and reports all changes made by you and by the vendor on a new release, then merges your changes with the new release to create new production versions of your programs. It's that simple.



**Aldon Computer Group**  
401 15th Street  
Oakland, California 94612  
(510) 839-3535  
(800) 825-5858  
FAX: (510) 839-2894

And the elegant Harmonizer user interface makes it easy to learn and use.

Conduct your own examination — for a free software trial, call toll free, 1-800-825-5858.

of the batteries and warning the operator if a problem is discovered.

The MegaRam-3000 can be configured with a redundant power supplies and an internal backup disk drive effectively creating a UPS. This guarantees that all stored data is completely protected regardless of brown-outs, power failures or even operator errors.

Other key features include optional extra SCSI interface ports (up to a total of four), advanced error detection and correction circuitry (EDAC). The multiporting features allows the unit to provide redundant data paths to a single host or access to the MegaRam from multiple host computers.

It is available in a tabletop or rackmount enclosure. Contact Imperial Technology Inc., 2305 Utah Ave., El Segundo, CA 90245; (800) 451-0666.

Circle 373 on reader card

### IPM Announces BalancedPower Advantage

International Power Machines (IPM) announced BalancedPower Advantage, a new family of single-phase UPSs to provide reliable power protection in a range from 600 to 2000 VA.

Features include: double conversion technology to remove harmful electrical disturbances; continuously regulated output power over the entire voltage range ensures optimum voltage being delivered to the protected equipment; a user-friendly monitoring panel provides detailed operational data; and an automatic online battery test that guarantees backup protection when it is needed.

Units may be stacked or placed on end to save space. Output ratings range from 600 to 2000 VA. Input voltages are 120, 208, 220, 230 and 240. Contact IPM, 2975 Miller Park N., Garland, TX 75042; (800) IPM-9959.

Circle 372 on reader card

### Pacific Data Products Ships OptiForm

Pacific Data Products announced OptiForm, a hardware and software solution that eliminates the cost and inconvenience of preprinted forms.

OptiForm is designed to work with any application that can print to an HP LaserJet 4-series printer. Blank forms can be designed with virtually any Windows-compatible application and then down-

loaded to OptiForm's Flash SIMM — a hardware module that plugs into the memory slot of the printer. Bidirectional support allows users to view the status and contents of the Flash SIMM directly from a workstation. For industries with sensitive documents (e.g., checks and signatures), the contents on the SIMM can be password-protected with OptiForm's SIMMlock.

Once the form is stored in Flash SIMM, it can be printed with the form's variable

data onto any blank paper stock by any application on the network.

OptiForm is available in 1, 2 and 3 MB models. Prices start at \$349, including the Windows-based OptiForm Management software.

Contact Pacific Data Products Inc., 9855 Scranton Rd., San Diego, CA 92121; (619) 552-0880.

Circle 371 on reader card

HP RENTALS • HP RENTALS • HP RENTALS • HP RENTALS

# HP WORKSTATION

## SALES & RENTALS

**WORKSTATIONS**

807	E55	NEW!	755	750	CRX	433 S	CRX	382	360	332
827	F20	J200	735	730	CRX-24	425 T	VRX	362	350	330
847	G30	K200	725	720	CRX-24Z	425 S	GRX	380	345	320
E25	H40	K400	715	710	CRX-48Z	425 E	PVRX	375	340	310
E35	I70	T500	712	705	GRX	400 S/T	EVRX	370		

**AND MORE ...**

Printers Plotters	X Terminals APOLLO ON Series	PC's Memory	Discs Test Equipment	800 Series Data Acquisition
----------------------	---------------------------------	----------------	-------------------------	--------------------------------

TSA is THE place for daily, weekly, monthly or long term rentals of Hewlett-Packard equipment. Ask about our 6-12 month purchase plans. Equipment available for same day shipment.

# 1-800-422-4872

713/935-1500 • Fax 713/935-1555 • Email: Info@tsa.com

**HEWLETT  
PACKARD**

Authorized  
Rental  
Company

THE RIGHT EQUIPMENT. RIGHT NOW.

# TSA

2040 West Sam Houston Parkway N. • Houston, Texas 77043

HP RENTALS • HP RENTALS • HP RENTALS • HP RENTALS

## ADAGER

The Adapter/Manager for  
IMAGE/SQL Databases  
obsoleted the need for database  
reloads back in 1978 and became  
the de facto standard for  
HP3000 systems worldwide.



Sun Valley, Idaho 83353-3000 U.S.A.  
Toll-free from Canada and the USA:  
Tel 800 533-7346 Fax 800 247-7346  
From other parts of the world:  
Tel 208 726-9100 Fax 247-8191

CIRCLE 121 ON READER CARD

## HEWLETT-PACKARD

# BUY SELL RENT REPAIR

9000 1000 3000 TEST

MEMORY - PLOTTERS - PRINTERS  
DISC DRIVES - WORKSTATIONS - DATA ACQUISITION



THE RIGHT EQUIPMENT. RIGHT NOW.  
2040 West Sam Houston Parkway N. • Houston, Texas 77043

# 1-800-422-4872

713/935-1500 FAX 713/935-1555

CIRCLE 228 ON READER CARD

## TUNE INTO HP

Pre-owned Equipment

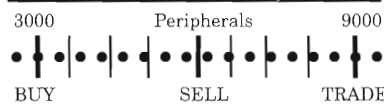

WORKSTATIONS  
CPUs  
DISC & TAPE DRIVES  
TERMINALS & PRINTERS  
3000/9000 MEMORY

# Lynne Company

(Phone #) 805-489-1564  
(Fax) 805-481-3799

CIRCLE 219 ON READER CARD

# HP 9000

WE BUY, SELL, RENT, LEASE

NEW 300, 400, 700, 800 USED

WORKSTATIONS  
SYSTEMS - MEMORY  
DISKS - PRINTERS

"HP IS OUR SPECIALTY - CALL US  
BEFORE YOU BUY OR SELL"



800-883-9339

612-551-9309 TEL  
612-551-9311 FAX

CIRCLE 229 ON READER CARD

## QUALITY HP EQUIPMENT WITHOUT THE HP PRICE

DON'T UPGRADE YOUR HP SYSTEM  
UNTIL YOU GET A SECOND OPINION  
FROM THE SECOND SOURCE FOR  
HEWLETT-PACKARD  
1000-3000-9000 EQUIPMENT

Consult with us about cost-saving alternatives

- Complete Configurations
- Individual CPUs-Peripherals
- Memory Upgrades and Feature Enhancements
- Classic and Spectrum Equipment

### WE BUY

Highest Prices Paid

### WE SELL

\*All Items Sold Are Guaranteed for HP Maintenance  
\*Short and Long Term Leases Available

### WE TRADE

Over 1000 satisfied Hewlett-Packard users are our  
customer references throughout the  
United States, Canada, Europe, and the Far East.



C.S.U. Industries Inc.  
207 Rockaway Turnpike Lawrence, NY 11559  
Ask for Mord: (516) 239-4310  
FAX (516) 239-8374



CIRCLE 205 ON READER CARD

## BUY • SELL • TRADE

COMPLETE HP SYSTEMS AVAILABLE

ALL PERIPHERALS

All items in stock — immediate delivery  
All warranted to qualify for manufacturer's  
maintenance.

## ConAm Corporation

Canada/US 800-926-6264  
California 310-419-2200  
FAX 310-419-2275

CDLA

## RENT • LEASE • MAINTENANCE

CIRCLE 210 ON READER CARD

HP Re-Marketing Specialists Since 1978

# 9000/1000

## WE BUY AND SELL:

700,400,300 WORKSTATIONS  
1000 A,E,F SERIES  
PRINTERS  
MASS STORAGE  
MONITORS

## MONTEREY BAY

COMMUNICATIONS  
tel: 408-429-6144  
fax: 408-429-1918

CIRCLE 229 ON READER CARD

## NORCO COMPUTER SYSTEMS, INC.

Hewlett-Packard Quality  
at a NorCo Price

1000 • 3000 • 9000 • 250

### BUY—SELL TRADE—LEASE

Processors, Peripherals  
and Systems

21337 Drake Road  
Cleveland, OH 44136-6620  
FAX: 216-572-0636  
216-572-4040 1-800-892-1920  
(Outside Ohio)

CIRCLE 221 ON READER CARD

The "HP Experts" for Over 25 Years!



Migration assistance with new HP  
hardware, system benchmarking,  
software testing, conversions,  
system rentals, outsourcing, and  
disaster recovery services.

## Computer Solutions, Inc.

# 201-672-6000

CIRCLE 209 ON READER CARD

## Allon Computer, Inc.

Quality, Integrity, Reliability  
Since 1989

Buying and Selling HP 1000/  
3000/9000 Terminals, Plotters,  
Disc Drives, PCs,  
Workstation Specialists

**1-800-808-0851**

**Fax: 813-724-6567**

**Direct Dial: 813-724-6566**

CIRCLE 251 ON READER CARD

## Surety systems, Inc.

Hewlett Packard Equipment  
And Maintenance Services

- HP 9000
- HP 3000
- HP 700 Series Workstations
- HP Peripherals

(713) 466-9455

A World Apart. A Phone Call Away.



Houston, TX. FAX (713)466-9454

SUIR-E-TY (ch00f-c4), n. 1. surcess: certainty, 2. security against loss or damage, 3. one who make himself responsible for another syn. assurance, commitment, bond, earnest, guarantee, pledge, security.

CIRCLE 226 ON READER CARD



## HARBORSIDE COMPUTER MARKETING

Buy/Sell/Lease All  
**HEWLETT PACKARD!**

Harborside Marketing, Inc.  
1010-A Park Court  
Safety Harbor, FL 34695  
813-799-2009  
FAX 813-791-6699

CIRCLE 215 ON READER CARD

## HEWLETT PACKARD

### Depot Repair

- Expert Depot Repair
- 5 Day Turnaround
- Emergency Exchange Program

**BLACK RIVER**  
COMPUTERS

**1-800-837-0061**

216-365-9950 Ohio  
216-365-3916 FAX

CIRCLE 171 ON READER CARD



## I/O Data Systems, Inc.

Buy - Sell - Lease - Trade  
**HEWLETT-PACKARD**  
Systems, Workstations  
Peripherals, Solutions



(216) 835-2211

27378 W. Oviatt  
Bay Village, OH 44140  
FAX: (216) 835-0220

CIRCLE 272 ON READER CARD

For  
**FREE  
PRODUCT  
INFORMATION**

Fill out the  
Reader Service Card  
in this issue!



## HEWLETT-PACKARD

1000 • 3000 • 9000

BUY • SELL • RENT • LEASE

MAINTENANCE

PROCESSORS • PERIPHERALS • SYSTEMS

## EURODATA INC.

(613) 745-0921

Fax: (613) 745-1172

2574 Sheffield Road, Ottawa, Canada K1B 3V7

CIRCLE 283 ON READER CARD

Introducing the First and  
**ONLY Source of OpenView  
Information Available!**

### Focus on OpenView:

*A Guide to Hewlett-Packard's Network  
and Systems Management Platform*

#### Book Highlights:

- The OpenView Framework
- Systems Management
- OperationsCenter
- Managing the Physical Network
- Managing the Multivendor Enterprise Network



Place your order now! Call Toll Free

**1-800-285-1755**

**Or FAX 215-643-8099**

## HEWLETT-PACKARD 9000 IT'S OUR SPECIALTY.

PRINTERS	PLOTTERS
LaserJets	DraftPros
DeskJets	DraftMasters
Rugged Writers	Electrostatics
	DesignJet

### WORKSTATIONS

Series 200, 300, 400, 700

We offer large discounts, outstanding service and immediate delivery. Call us before you buy a printer or plotter!



4117 2nd Avenue South  
Birmingham, AL 35222

(205) 591-4747 or (800) 638-4833

E-mail: sales@dasher.com Fax: (205) 591-1108

CIRCLE 233 ON READER CARD

This publication is  
available in microform  
from UMI.

## U·M·I

A Bell & Howell Company  
300 North Zeeb Road, Ann Arbor, MI 48106 USA  
800-521-0600 toll-free  
313-761-4700 collect from Alaska and Michigan  
800-343-5299 toll-free from Canada

### HP CAREERS NATIONWIDE

PERM AND CONTRACT  
OPPORTUNITIES ABOUND!!!!

- MPE or HP-UX SYSTEMS MGMT.
- UNIX and C Development
- Relational (RDMS) DB Administration
- 3GL and 4GL Application Development
- NETWORKING -LAN/WAN's
- PC Support and Development
- Manufacturing or Financial Applications

Call - Amos & Associates



Diane Amos, C.P.C.

633-B Chapel Hill Road  
Burlington, N.C. 27215  
(910) 222-0231  
FAX: (910) 222-1214

CIRCLE 204 ON READER CARD

### Sales Manager

A Minneapolis based developer of software is seeking an experienced Sales Manager to join our team. The incumbent will be a senior sales person with management experience, will understand needs of the report distribution market IBM downsizing needs, and the UNIX market.

Candidates for this position must have at least 10 years of experience in sales, including 5 years of experience in marketing applications software and 5 years in management. The incumbent will be responsible for building and implementing a sales strategy, building and managing a sales team, and establishing strategic partnerships with distributors and system users. Candidates should be familiar with the open-systems/client server market.

Compensation for this position will include a competitive salary, a full-benefits package, and bonuses up to 100% of the base.

Please send resumes, along with salary expectations, and three references of individuals familiar with your work, to: **NAS REPLY SERVICE, Dept. 9MP13, One Appletree Square, Minneapolis, MN 55425.** Equal Opportunity Employer.

# CONSULTANT showcase

## HP SPECIALIST

CONTRACT &  
PERMANENT

26 YEARS OF  
PROFESSIONAL  
EXPERTISE

DAN KESLER  
KEN WALTERS & ASSOC.  
6685 FALLS OF NEUSE  
SUITE 208  
RALEIGH, NC 27615  
919/847-7772  
FAX: 919/676-1662

CIRCLE 195 ON READER CARD

## HP CAREER SPECIALISTS

INFOTECH SEARCH GROUP, Ltd.  
"Professionals serving Professionals"

- We specialize in the placement of **PERMANENT** and **CONTRACTING** Hewlett Packard talent
- Let experienced professionals with a proven track record of success **work for you.**

Call Brian M. Donahue  
Phone: 910-538-0123  
Fax: 910-538-0126  
P.O. Box 2195  
Burlington, NC 27216-2195

CIRCLE 255 ON READER CARD

**SWC** **SPEEDWARE**  
SW Consulting, Inc. Business Partner

SW Consulting, Inc. is currently looking for Information Systems professionals who are interested in turbo charging their careers. We are currently looking for candidates with the following experience:

Speedware Cobol Turbo Image Omnidex/Imsam

Salaries for professionals with one or more of these skills range from \$45k - \$75k/yr. If you have any of these skills and aren't earning top dollars for your knowledge and would like to pursue a career as an Information Systems Consultant, then mail or fax your resume to:

SW Consulting, Inc.  
13180 N Cleveland Avenue Phone:(800) 494-4977  
Suite 112 (813) 656-1011  
N. Ft. Myers, Florida 33903 Fax: (813) 997-0456

## INFORMATION

Size: 1/9 page — 2<sup>3</sup>/<sub>16</sub>" x 2<sup>3</sup>/<sub>4</sub>"

Rates:

1 time: \$550  
3 times: \$495

COLOR NOW  
AVAILABLE  
**\$100**

6 times: \$440  
12 times: \$385

- Typesetting and composition available.
- Camera ready mechanical required.

For more information call:  
**Lisa Merck (708) 655-0100**



# ADVERTISERS INDEX

Reader Service Number		Page
163	Aldon Computer Group	66
181	Aurora Technologies	43
171	Black River Computers	64
242	Camintonn Corp.	8
454	CMI	52
220	Computer Network Technology/Brixton	5
232	Concorde Technologies	32
232	Concorde Technologies	47
231	Datastructure	49
	Digital Equipment - MA	38,39
185	EAC	34
	ENTERPRISE EXPO	INSERT
190	FutureSoft	30
132	Graymatter Software	52
	Hewlett Packard - CA	12,13
	Hewlett Packard	COVER 3
	IBM Corp.—AS/400	COVER 2
	IBM Corp.—AS/400	INSERT
122	IEM, Inc.	122
247	Information Builders, Inc.	17
167	Innovus, Inc.	21
281	Insignia Solutions Inc.	51
138	ITAC Systems, Inc.	62
281	Kingston Technology Corp.	1
452	Legasys International	4
123	M.B. Foster Associates	41
472	MiniSoft, Inc.	50
154	Mitchell Humphrey & Co.	48
246	Newport Digital Corp.	6
256	NSD, Inc.	58
130	OMTOOL	46,47
254	Penril Datability Networks	45
176	PNY Electronics, Inc.	15
112	Polaris Service Inc	54
481	Quest Software	55
462	Quest Software	57
464	Quest Software	59
483	Quest Software	61
268	Quest Software	63
261	Simple Technology	19
123	Software Licensing Corp.	64
230	Sterling Software	25
151	TechGnosis	60
214	Texas ISA, Inc.	27,53
477	Tryonics Inc.	54
137	Technical & Scientific Applications (TSA)	67
139	Unison Software	56
	Walker Richer & Quinn, Inc.	COVER 4
194	Western Scientific	23

UNIX is a registered trademark of AT&T in the U.S.A. and in other countries.  
 MS-DOS is a trademark of Microsoft Corp.  
 Macintosh is a trademark of Apple Computer Inc.  
 X Window System is a trademark of MIT.  
 Windows is a registered trademark of Microsoft Corp.  
 Windows NT is a registered trademark of Microsoft Corp.  
 NetWare is a registered trademark of Novell Inc.

# ADVERTISING SALES OFFICES

Leslie Ringe, Publisher  
 (215) 643-8070

## EAST COAST, MIDWEST

(201) 746-5635

Joseph Bigley, Regional Sales Manager  
 64 Elston Road  
 Upper Montclair, NJ 07043  
 FAX (201) 746-5937

## SOUTHCENTRAL

(215) 643-8070

Leslie Ringe, Regional Sales Manager  
 1300 Virginia Drive, Suite 400  
 Fort Washington, PA 19034  
 FAX (215) 643-8099

## NORTHWEST/SOUTHWEST

(301) 207-8222

Luisa Peticucci, Regional Sales Manager  
 Suite 1125  
 12424 Wilshire Blvd.  
 Los Angeles, CA 90025  
 FAX (310) 207-4082

## EUROPE

33 42 93 27 63

Fran Grega, European Sales Manager  
 4 Terrasses St. Jerome  
 8 Avenue de la Cible  
 13100 Aix-en-Provence France  
 FAX 33 42 27 21 17

## ASIA

65 291 9861

Margaret Liu, Asian Sales Manager  
 Keith Chin, Account Manager  
 BLK 105, Boon Keng Road  
 #04-17, Singapore 1233  
 FAX 65 293 1445

Cheryl DeMaoribus, Marketing Services Manager

Lisa Merck, Card Deck Manager

Cathy Dodies, List Rental Manager

Lisa Merck, Product Showcase Sales Manager



1300 Virginia Dr., Ste. 400  
 Fort Washington, PA 19034  
 (215) 643-8000 FAX (215) 643-8099

# & ANOTHER THING . . .



1. Please rate HP Professional on the following:

	Excellent	Could Be Better	Don't Care
Accuracy	<input type="checkbox"/>	<input type="checkbox"/>	<input type="checkbox"/>
Technical Merit	<input type="checkbox"/>	<input type="checkbox"/>	<input type="checkbox"/>
Style/Tone	<input type="checkbox"/>	<input type="checkbox"/>	<input type="checkbox"/>
Timeliness	<input type="checkbox"/>	<input type="checkbox"/>	<input type="checkbox"/>
Graphics and Design	<input type="checkbox"/>	<input type="checkbox"/>	<input type="checkbox"/>

2. Indicate which Column and Department in 1995 you liked best (B) and least (L).

<p><b>Columns:</b></p> <p><input type="checkbox"/> And Another Thing . . .      <input type="checkbox"/> PC Tips</p> <p><input type="checkbox"/> Integrating Your HP 3000      <input type="checkbox"/> Standards</p> <p><input type="checkbox"/> Networking PCs                      <input type="checkbox"/> UNIX</p> <p><input type="checkbox"/> Network Management              <input type="checkbox"/> UNIX SYS_ADMIN</p> <p>Why? _____</p>	<p><b>Departments:</b></p> <p><input type="checkbox"/> Editorial                              <input type="checkbox"/> Product Watch</p> <p><input type="checkbox"/> Industry Watch                      <input type="checkbox"/> New Products</p> <p><input type="checkbox"/> INsites                                <input type="checkbox"/> Strategic Directions</p> <p>Why? _____</p>
---	---

3. Help us gauge your interest in the following technologies and their specific topics:

	Got To Know Now	Might Be Interesting	Who Cares
Data Warehousing	<input type="checkbox"/>	<input type="checkbox"/>	<input type="checkbox"/>
Service & Support	<input type="checkbox"/>	<input type="checkbox"/>	<input type="checkbox"/>
UNIX	<input type="checkbox"/>	<input type="checkbox"/>	<input type="checkbox"/>
Multiplatform Storage Management	<input type="checkbox"/>	<input type="checkbox"/>	<input type="checkbox"/>
Personal Computers	<input type="checkbox"/>	<input type="checkbox"/>	<input type="checkbox"/>
Enterprise Networks	<input type="checkbox"/>	<input type="checkbox"/>	<input type="checkbox"/>
Document Management	<input type="checkbox"/>	<input type="checkbox"/>	<input type="checkbox"/>
Corporate Communications	<input type="checkbox"/>	<input type="checkbox"/>	<input type="checkbox"/>
Vertical Applications	<input type="checkbox"/>	<input type="checkbox"/>	<input type="checkbox"/>
Application Software Development	<input type="checkbox"/>	<input type="checkbox"/>	<input type="checkbox"/>
Disaster Recovery/Business Continuity	<input type="checkbox"/>	<input type="checkbox"/>	<input type="checkbox"/>
Distributed Computing	<input type="checkbox"/>	<input type="checkbox"/>	<input type="checkbox"/>

Check all that interest you:

- |  |   |   |   |
|--|---|---|---|
| <input type="checkbox"/> 4GLs/RDBMS      | <input type="checkbox"/> Integrators/VAR Programs | <input type="checkbox"/> Multimedia             | <input type="checkbox"/> EDI                        |
| <input type="checkbox"/> Optical Storage | <input type="checkbox"/> PC Desktops              | <input type="checkbox"/> PC-to-UNIX Integration | <input type="checkbox"/> RAD Tools                  |
| <input type="checkbox"/> OLAP            | <input type="checkbox"/> Remote Monitoring        | <input type="checkbox"/> Network Printing       | <input type="checkbox"/> Automated Software Testing |
| <input type="checkbox"/> Tape Backup     | <input type="checkbox"/> Workstations             | <input type="checkbox"/> Remote Access          | <input type="checkbox"/> GUI Tools/Interface Design |
| <input type="checkbox"/> Query Tools     | <input type="checkbox"/> PC Servers               | <input type="checkbox"/> Imaging/Forms          | <input type="checkbox"/> Security                   |
| <input type="checkbox"/> HSM             | <input type="checkbox"/> SNMP/CMIP                | <input type="checkbox"/> Enterprise E-mail      | <input type="checkbox"/> Mobile Computing           |

4. What was your favorite issue in 1995? \_\_\_\_\_

5. What was your favorite article in 1995? \_\_\_\_\_ least? \_\_\_\_\_

6. Please list other technologies or topics you would like to see covered in HP Professional in 1996:

\_\_\_\_\_

# Open Your Windows

A breakthrough in Windows access  
for UNIX workgroups.

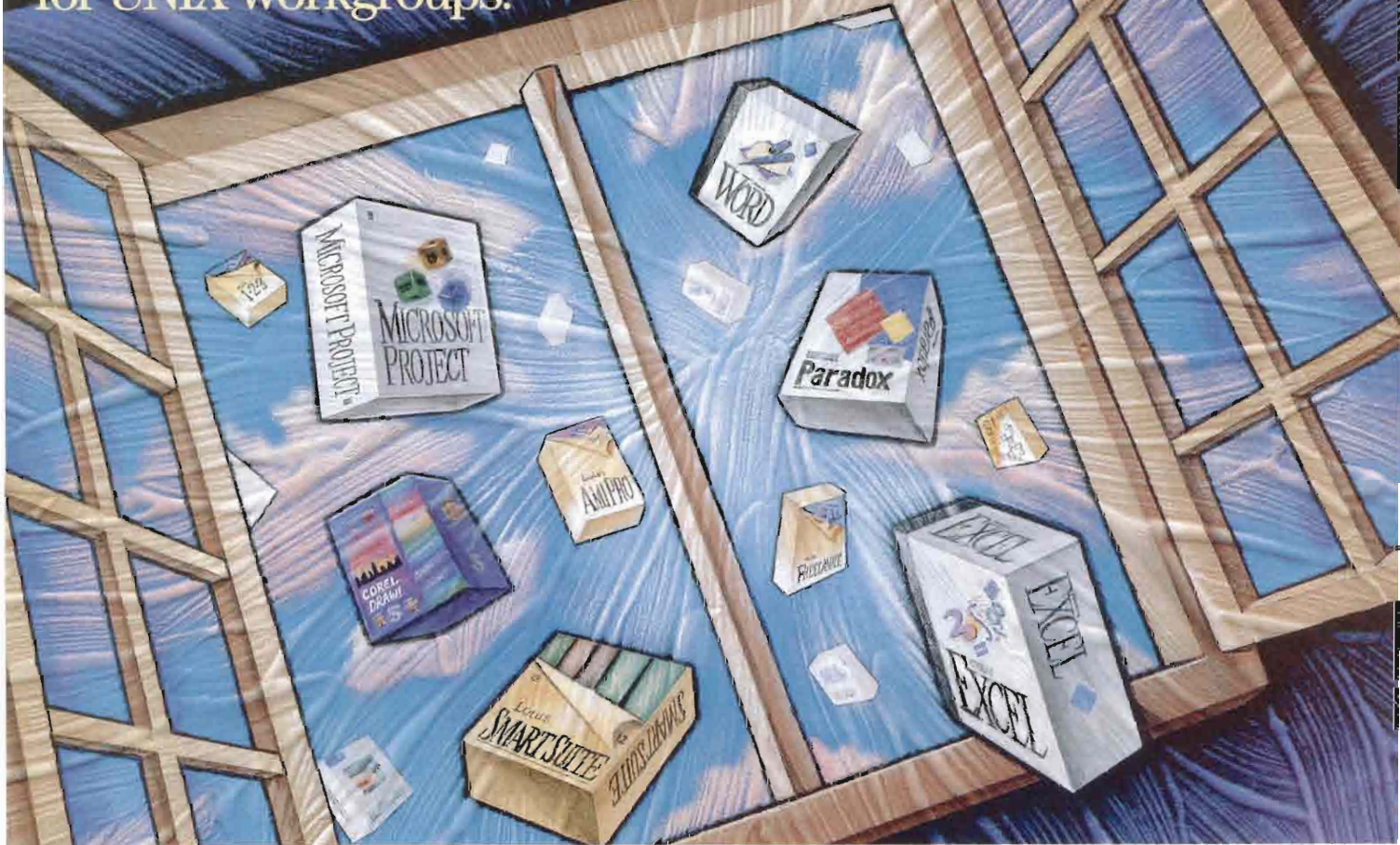

All trademarks are the property of their respective owners.

## The new HP 500 Windows Application Server lets your PC applications fly.

Hewlett-Packard has created the ultimate solution to the long standing problem of delivering Windows and DOS applications to UNIX workstations and X terminals. The HP 500 Windows Application Server is a revolutionary total solution based on open systems standards. Using a Pentium server, together with the X Window System, HP has developed a breakthrough in PC application access.

The HP 500 actually runs PC applications in native mode, delivering the exact look and feel you'd expect, with performance up to 10 times faster than other solutions. You can even cut and paste between PC and UNIX applications, and have full access to network printers and files stored anywhere on the NFS-network.

### Add X terminals for significant cost savings.

The HP 500 allows you to economically deliver superior PC application access to every desktop on

your network. Combine it with the centralized administration benefits of X terminals, and you could save 48% on your total cost of ownership compared to PC's.

### So go ahead, open your Windows.

Call 1-800-637-7740 ext. 9763 for your free copy of the HP 500 demonstration video and white paper. Look for us on the Internet (<http://www.hp.com>), or ask your HP representative or Channel Partner about the new HP 500. Then get ready to deliver productivity to the desktop and savings to the bottom line.



MONDAYS,  
AS DESIGNED BY  
NETWORK PROFESSIONALS.

ENTERPRISE-WIDE  
CONNECTIVITY, AS DESIGNED  
BY NETWORK PROFESSIONALS.

If it were up to you, your hard work would finally pay off. Mainframes, PCs, minicomputers and servers would all fit together seamlessly, and Monday would be just another day at the beach.

#### REFLECTION® SOLUTIONS

##### REFLECTION PC-TO-HOST CONNECTIVITY SOFTWARE

- ▲ UNIX, X, HP, DIGITAL, AS/400 AND 3270 CONNECTIVITY
- ▲ WINDOWS, DOS, AND MACINTOSH PLATFORMS
- ▲ INTUITIVE OPERATIONS, FAST FILE TRANSFER, ADVANCED TEXT AND GRAPHICS EMULATION, AND POWERFUL PROGRAMMING TOOLS

##### REFLECTION NETWORKING SOFTWARE

- ▲ COMMUNICATIONS: TCP/IP, UDP, LAT, NS/VT, IPX/SPX, SLIP, CSLIP
- ▲ ARCHITECTURE: VxD/DLL DESIGN; 100% WINDOWS SOCKETS COMPLIANT
- ▲ FULL-FEATURED APPLICATIONS (FTP, LPR/LPD, INTERNET ACCESS)
- ▲ EASY CONFIGURATION AND MANAGEMENT
- ▲ OPTIMIZED FOR MOBILE/WIRELESS COMPUTING

AVAILABLE AS SUITES AND INDIVIDUAL PRODUCTS, TAILORED FOR ANY ENTERPRISE CONFIGURATION.

CALL 800.926.3896 IN EUROPE, CALL +31.70.375.11.00  
OUTSIDE EUROPE, CALL 206.217.7100.  
INTERNET: sales@wrq.com WEB: http://www.wrq.com

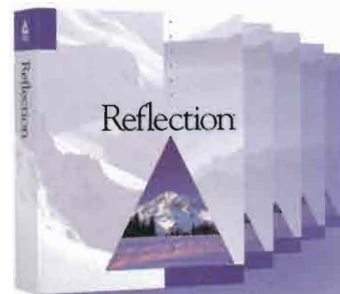

Impossible? Not with Reflection® from WRQ. Reflection offers complete, integrated PC connectivity software for your entire enterprise—including transport protocols, PC X server software, and terminal emulation. All with the management features, open standards, and service and support you need.

To try connectivity designed from your point of view, call today for a free evaluation copy. We'll make sure that from here on out, your Mondays go swimmingly.

For a FREE evaluation copy,  
of any Reflection® product, call  
**800.926.3896**

 **Reflection**  
CONNECTIVITY FOR A CHANGING WORLD

