

HP Professional

AN INDEPENDENT PUBLICATION FOR USERS OF HP COMPUTERS ■ VOL. 3 ■ NO. 3 ■ \$4.00

MARCH 1989

- Network Management
- Public, Private And Hybrid X.25 Networks
- Curing LIF Hard Disc Indigestion



AB

r
w



User Friendly.

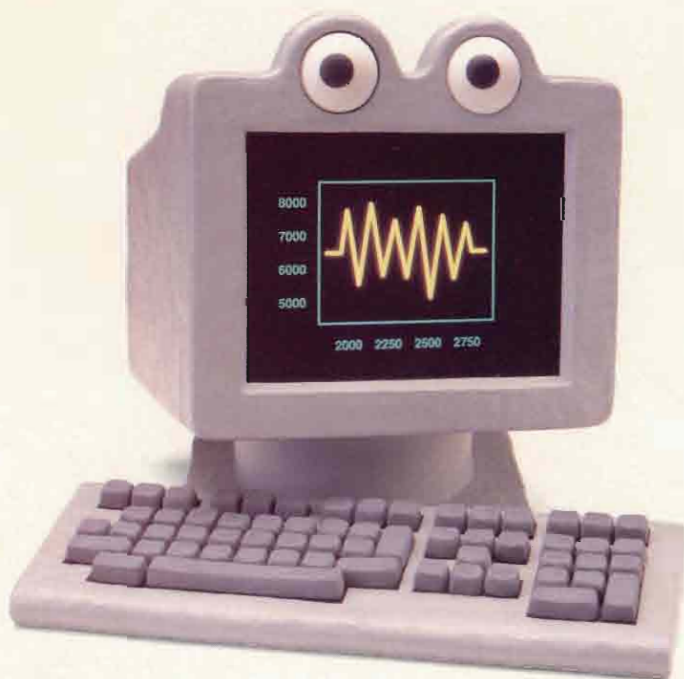

Take advantage of our friendliness. Accountants, controllers, human resource executives and chief financial officers across the nation do. Of course, Collier-Jackson systems are comprehensive, full-featured. Written and designed specifically for Classic and HP Precision Architecture. Not to mention flexible and integrated. But, that's all transparent to our users. Simple. Straight-forward. Easy to Use. Put them at the top of your list. They're at the top of ours.



HP 3000
NATIONAL
PROGRAM

CJ/ADVANCED GENERAL LEDGER™
CJ/ACCOUNTS PAYABLE™

CJ/ACCOUNTS RECEIVABLE™
CJ/FIXED ASSETS™

CJ/PURCHASING™
CJ/PAYROLL™

CJ/PERSONNEL™
CJ/EMPLOYEE FUND
ADMINISTRATION™

CJ/REPORT WRITER™
CJ/EXECULINK™

Collier-Jackson, Inc./3707 West Cherry Street/Tampa, FL 33607/(813)872-9990

CIRCLE 164 ON READER CARD

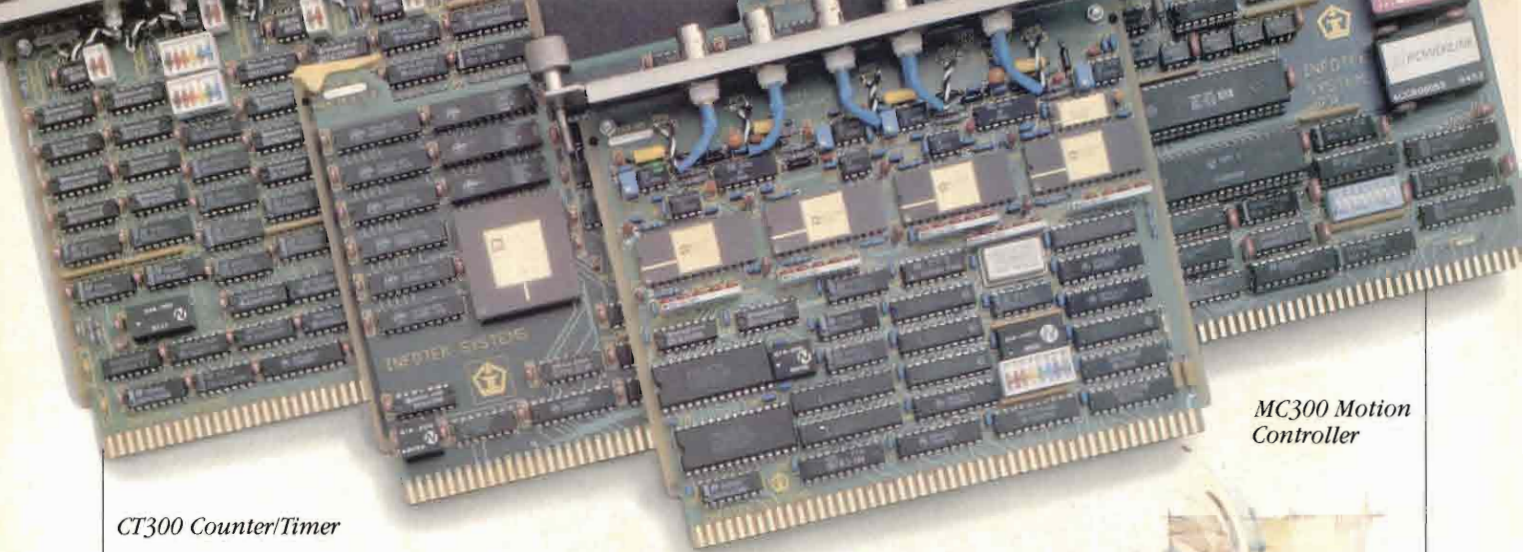

CT300 Counter/Timer

DSP316 Digital Signal Processor

DA300 D/A Converter

MC300 Motion Controller



Imagine The New Possibilities In HP Data Acquisition And Control.

Now, four new data-acquisition, analysis and control products are available for your Hewlett-Packard 9000 200/300 computer—from Infotek, the world leader in HP enhancements.

The new, economical Infotek DA300 digital-to-analog converter features four independent channels with 16-bit precision. Modes of operation include direct voltage output or waveform generation, supported by a 64K buffer. It's a first for

HP 9000 users.

Another first, the CT300, is the industry's only board-level four-channel Counter/Timer for HP Series 200/300 computers. Each channel operates independently with 16- or 32-bit accuracy. Input rates up to 20 MHz can be achieved in counter mode.

For signal processing applications such as FFTs and digital filtering, Infotek introduces the DSP316. Based on a fixed-point DSP and 16-bit data memory, this single-slot coproc-

essor operates at up to eight million instructions per second.

And now Infotek also makes available a programmable motion controller, the MC300, for control of d.c., d.c. brushless and stepper motors.

With the popular family of A/D converters, Infotek offers the most complete

line of data-acquisition and control products for HP users. Imagine the new possibilities, then call or write today to Infotek Systems, 1045 S. East Street, Anaheim, California 92805-8508, (714) 956-9300, (800) 227-0218, in California (800) 523-1682, TELEX 678870, FAX: (714) 491-8644.



**INFOTEK
SYSTEMS**

Join the Optical Revolution

IEM led HP computer users into the optical revolution with 600 and 800 MByte optical disk drives. Now, we're going one step further with our 16—90 GByte capacity optical disk jukebox systems. Media compatible with our 600 and 800 MByte disk cartridges, these jukeboxes complement the advantages of optical drives with the convenience of automatic cartridge selection.

IEM optical disk products come complete with all necessary software, and are available for a wide variety of HP machines (including the 1000, 3000 and 9000).

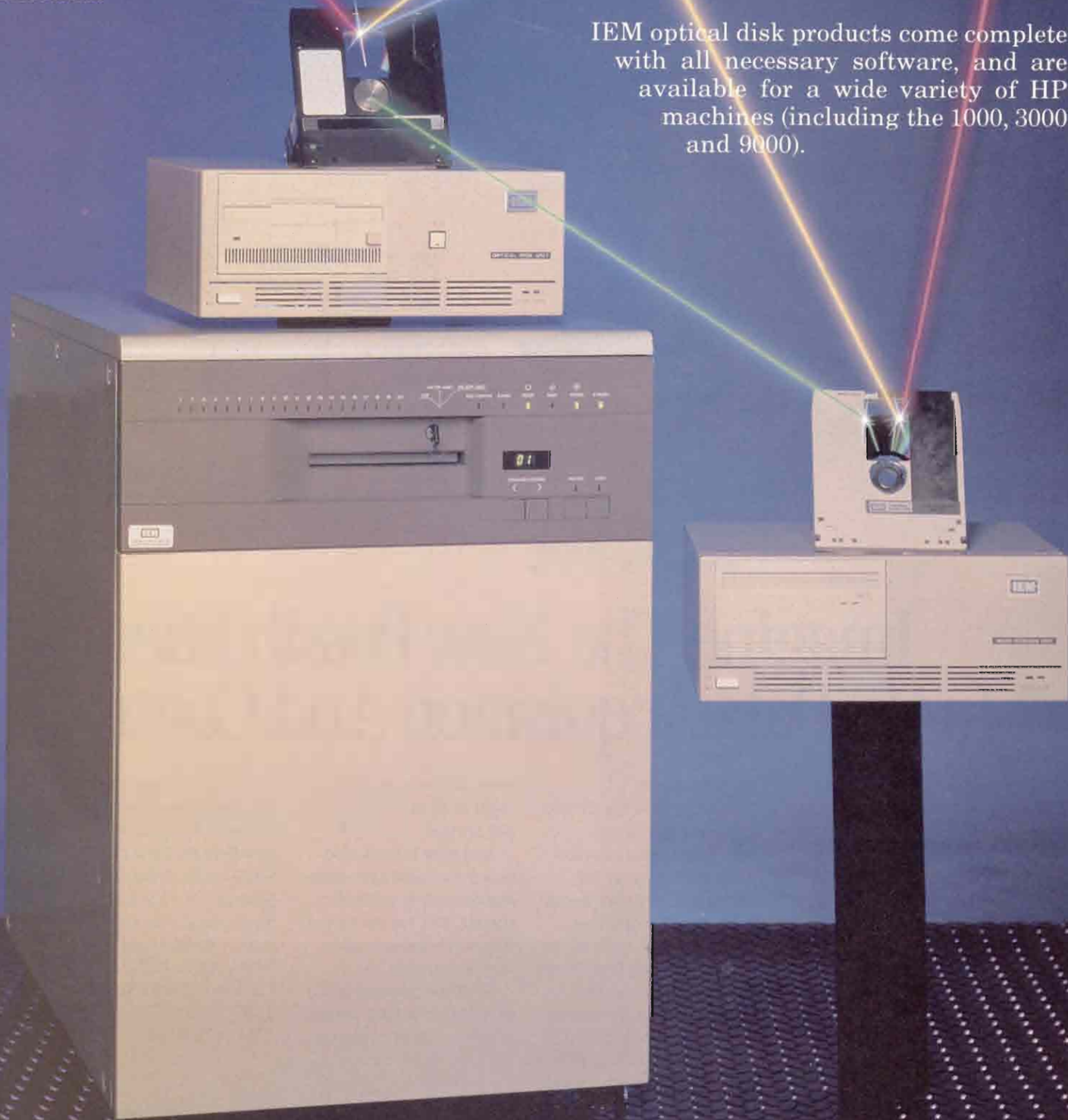

Expand Your Horizons

CIRCLE 117 ON READER CARD



IEM, Inc. P.O. Box 8915
Fort Collins, CO 80525
(303) 223-6071 • (800) 321-4671
TWX 910-930-9445 • FAX (303) 223-4246

C ONTENTS

MARCH 1989

VOL. 3, NO. 3

26 **FOCUS: Selecting The Right Network Management System** *by Sharon Fisher*

Migration To OSI Protocols.

30 **FOCUS: Map 3.0 For Factory LANs: Migration Or Coexistence** *by Peggy King*

Can OSI And TCP/IP Coexist?

34 **FOCUS: Distributed Databases** *by Roger Lawson*

The State Of The Art.

42 **FOCUS: Public, Private And Hybrid X.25 Networks** *by Gordon McLachlan*

Selecting The Right Network Is Your Most Important Decision.

50 **Designing A LAN, Part 2** *by Ken Fullett*

COMSAT Laboratories Explains How To Solve Connectivity Problems.

58 **Installing CIM At Rockwell** *by David A. Lindberg*

Using Networked HP CAD Workstations Improved Quality And Saved Money.

COLUMNS

FROM THE LAB:

The HCT Terminal By Cumulus

by Sheldon Green

Good Value And Low Price70

RDBMS: Table Arithmetics

by Fabian Pascal

The 'Arithmetics' Available For R-Tables74

STORAGE: Curing LIF Hard Disc Indigestion

by Don Person

Stretching Your Directory,
No Matter How Small.....78

PC TIPS: Capture Special Keys

by Miles B. Kehoe

Save The New User Added Frustration.....82

HP-UX: Shells And Special Commands

by Andy Feibus

HP-UX Input And Output84

DEPARTMENTS

Editorial 8

Industry Watch 10

News & Trends 14

New Products..... 22

Product Showcase..... 92

Consultants Directory..... 92

Software 95

Advertisers Index..... 96

Calendar..... 96



Introducing . . .

FROM THE LAB

A Monthly Review Of
New Products From Our
HP Professional Testing
Center (p.70).

On The Cover:

This month's cover
illustration is the work
of Michael Schroeder,
Reading, PA.

WIN/TCP™ for MPE/V Jump the hurdles to TCP/IP.

HP 3000 users can now run TCP/IP
ARPA Services like TELNET, FTP, and
SMTP.

WIN/TCP for MPE/V speeds you over
the hurdles and into full connectivity
via the NS/X.25 3000/V Link for DDN and
Wide Area Networks, ThinLAN 3000/V,
or ThickLAN Links.

Jump up and call 800-872-8649 or
800-962-8649 (in Calif.) or write The
Wollongong Group, 1129 San Antonio
Road, Palo Alto, CA 94303.

WOLLONGONG

We are the standard.™

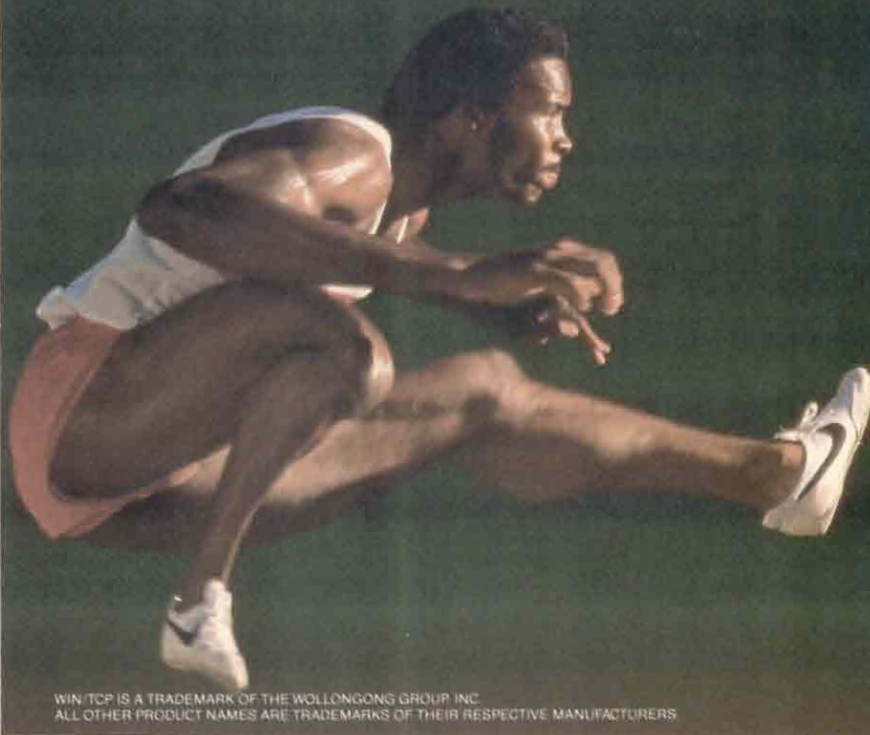

WIN/TCP IS A TRADEMARK OF THE WOLLONGONG GROUP, INC.
ALL OTHER PRODUCT NAMES ARE TRADEMARKS OF THEIR RESPECTIVE MANUFACTURERS.

CIRCLE 143 ON READER CARD

HP Professional

Publisher: Carl B. Marbach
Editorial Director: R.D. Mallery

Editorial

MANAGING EDITOR Thomas M. Halligan
COPY EDITOR Andrea J. Zavod
WEST COAST EDITOR Peggy King
FIELD SERVICE EDITOR Ron Levine
CONTRIBUTORS Andy Feibus, Sharon Fisher,
Ken Fullett, Sheldon Green, Miles B. Kehoe,
Roger Lawson, David A. Lindberg, Gordon
McLachlan, Fabian Pascal, Don Person

Design & Production

DESIGN/PRODUCTION MANAGER Ruth Ann Leiby
DESIGN/PRODUCTION ASST. Pat Messina
ADVERTISING BOOKING COORD. Lori Goodson
ADVERTISING PROD. COORD. Suzanne Garr
TRAFFIC/PRODUCTION ASST. Kim Macheski
PROMOTIONS MANAGER Tim Kraft
GRAPHIC DESIGNERS Richard Kortz,
Sue Ann Rainey
PRODUCTION ARTISTS Patricia P. Kraekel,
Kristy Yates
TYPESETTING MaryEllen Coccimiglio

Circulation

CIRCULATION DIRECTOR Carrie Eisenhandler
CIRCULATION MANAGER Betsy Ellis
FULFILLMENT MANAGER Margie Pitrone
CIRCULATION DBA Rebecca Schaeffer

PROFESSIONAL PRESS, INC.

PRESIDENT Carl B. Marbach
VICE PRESIDENT R. D. Mallery
VICE PRESIDENT Peg Leiby
VICE PRESIDENT Helen B. Marbach
EXECUTIVE EDITOR Linda DiBasio
EXECUTIVE DESIGN DIRECTOR
Leslie A. Caruso
DIRECTOR OF MARKETING Mary Wardlaw
CONTROLLER Andrea Beneke
ASSISTANT TO THE PUBLISHER
Jan Krusen

For information on how to contact your sales
representative, see page 96. Editorial, advertising
sales and executive offices at 921 Bethlehem Pike,
Spring House, PA 19477 ■ (215) 542-7008
TWX 910 333 9522 ■ Easylink 62805174
FAX (215) 628-2845

HP PROFESSIONAL ISSN 0986145X is published
monthly by Professional Press, Inc., 921 Bethlehem Pike,
Spring House PA 19477. Subscriptions are complimentary
for qualified U.S. and Canadian sites. Single copy price, in-
cluding postage, \$4. One year subscription rate \$30 U.S. and
Canada; \$60 foreign. All orders must be prepaid. Second
Class postage paid at North Wales, PA, and additional mail-
ing offices. POSTMASTER: Send all correspondence and
address changes to HP PROFESSIONAL, P.O. Box 445,
Spring House, PA 19477. COPYRIGHT © 1989 by
Professional Press, Inc. All rights reserved. No part of this
publication may be reproduced in any form without writ-
ten permission from the publisher. All submitted manu-
scripts, photographs and/or art work are sent to Professional
Press, Inc. at the sole risk of the sender. Neither Professional
Press, Inc. nor HP PROFESSIONAL magazine are respon-
sible for any loss or damage. HP PROFESSIONAL is an
independent journal not affiliated with Hewlett-Packard
Company. HP and Hewlett-Packard are registered
trademarks and HP PROFESSIONAL is a trademark of
Hewlett-Packard Company.

✓BPA

ABP

REPRINTS? If you would like reprints of any article or advertisement,
contact Reprint Resources, 155 Commerce St., Fort Washington, PA 19034
(215) 643-9143, FAX (215) 643-9164.

With release 5.2

DBGENERAL wins again!

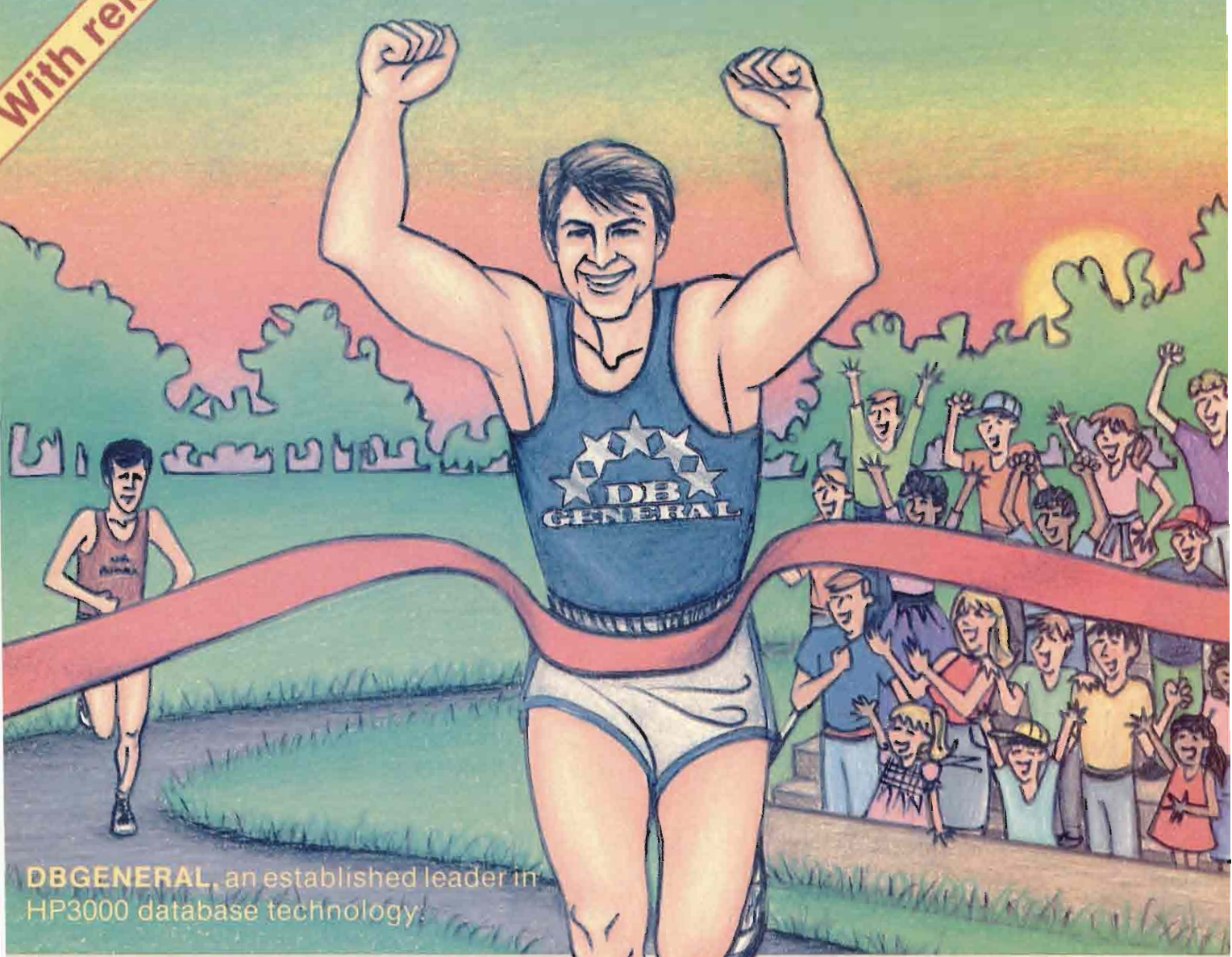

DBGENERAL, an established leader in HP3000 database technology:

1984: **DBGENERAL** introduces global structural changes and revolutionizes database restructuring. Today, it is the database standard.

1984: **DBGENERAL** introduces automatic capacity management. Today, it's a database standard.

1985: **DBGENERAL** introduces performance monitoring to optimize database throughput. Today, diagnostics are a normal part of database management.

1986: **DBGENERAL** announces around-the-clock support. Companies rely on their databases too much to do with less than expert care at all times.

1987: **DBGENERAL** is first to support TurboIMAGE and introduces an online manual and contact-sensitive help. No more searching for a manual.

1988: **DBGENERAL** again sets new standards:

- ★ offers a fast compressed backup with STORBASE, which uses Tymlab's proven BackPack™ technology
- ★ provides a fully compatible Spectrum version on TurboIMAGE/XL
- ★ incorporates an interactive job stream generator



BRADMARK

Computer Systems Inc.
CIRCLE 180 ON READER CARD

Houston

4265 San Felipe Avenue
Houston, TX 77027
(713) 621-2808
Fax (713) 621-1639

Australia
Belgium
Belgium
Canada
Denmark
France

61 (02) 484 3979
32 (056) 41 83 99
32 03/237 79 06
(613) 448-2333
45 (1) 822211
33 (1) 45 88 88 30

Germany
Germany
Holland
Israel
Scandinavia
UK

49 089/6088 3077
49 06722/6046
31 (30) 52-1114
972-3-413782
46 0910-364 80
44 (0223) 460881

Buffalo
Cincinnati
Los Angeles

(716) 689-6882
(513) 891-7867
(213) 432-7713



Session for Windows. The next generation in HP to PC connectivity.

The Microsoft® Windows environment has opened a new era in software for PCs and compatibles. With a speedy mouse and a powerful keyboard. Intuitive, well-organized menus and dialog boxes. Cut and Paste facilities for moving data between documents. The ability to run multiple applications at one time, each in a separate window on your screen. A standard interface for all applications, so manuals are almost obsolete. And with all the new Windows-based software from Hewlett-Packard—NewWave, OpenView, LaserROM, and LaserRX—it's clear that this is a trend no HP site can ignore.

A Windows-based terminal emulator

Business Session™ for Windows, our HP2392 terminal emulator, is part of this new breed of PC software. Business Session provides block-mode terminal operation with LAN compatibility, intelligent file transfer, automated command scripts and powerful logging, all within the high-productivity desktop environment of

Windows 2.0, 286 or 386. Building on the user interface we've spent four years designing and refining for our Macintosh-based emulators, Business Session takes advantage of Windows' mouse, icon and menu paradigm to boost user productivity. And because our PC- and Mac-based products share a common interface and feature set, companies with both types of computers can standardize on Session to reduce training time and simplify in-house support.

Window on the future.

Because Windows is the stepping stone to HP NewWave and OS/2 Presentation Manager, Business Session lets you increase your productivity with the hardware you have now—and protect your investment in software and training as you move to these powerful new environments. Get ready for the future . . . Choose Session.

The logo for Tymlabs, featuring the word "Tymlabs" in a stylized, handwritten-style font with a horizontal line underneath.

Tymlabs Corporation • 811 Barton Springs Road • Austin, Texas 78704 U.S.A. • (512) 478-0611 • Telex 755820
Wick Hill Associates Ltd. • 42A-44 High Street • Egham, Surrey, U.K. TW20 9DP • 0784-38441 • Telex 268764
Tymlabs-APPIC • 123 Rue de Petit-Vaux • 91360 Epinay sur Orge, France • (1) 64-54-87-37 • Telex 603409
Megatec Pty., Ltd. • 2 Brunswick Road • Mitcham, Victoria 3132, Australia • (03) 874-3633 • Telex 152692
Infosistemas Financieros S.A. de C.V. • Bahía de Guantánamo 79 • 11300 México, D.F. • 254-3274 254-3284
HPS Software Developments Limited • 196a Whittington Road • London N22 4PD England • 01-881-6644 • Telex 265871

Business Session is a trademark of Tymlabs Corp. Business Session for Windows was developed by HPS Software Developments Limited. Microsoft is a registered trademark of Microsoft Corp.

CIRCLE 138 ON READER CARD

Better Than Ever!

The first product review from our Laboratory and Testing Center appears in this issue (see From The Lab, page 70). Our 3000 now is in service and available to our editorial staff for reviewing products.

When you see our lab seal on a review it means that we have reviewed the product in our own Lab environment.

The Lab is a tradition at Professional Press. We take it very seriously and spend serious money developing it. Later this year, it will be an interoperability showcase for multivendor platforms, including MPE, HP-UX, ULTRIX, VMS and our newest addition, IBM's OS/400.

ARIS

Today we are making ARIS, our on-line bulletin board service (BBS) available to *HP Professional* subscribers. ARIS, which stands for Automated Reader Information Service, is a full-function BBS with several SIGs available. Best of all, it's *free* to our subscribers.

ARIS is a direct line to the editors and your colleagues in the HP market. You can download programs published in this magazine, communicate with our editors, request a change of address, find additional information about advertisers, order books and back issues, check the guidelines for submitting articles, take a peek at our editorial calendar for the year and communicate with other HP users.

To access ARIS, all you need is a PC or a terminal with a modem and your subscription number and your name as it appears on the mailing label on the front of this or any issue. Here's how to get on-line...

Set your PC to seven data bits, one stop bit and space parity, or eight data bits, one stop bit and no parity (300, 1200, 2400 baud available).

The terminal emulation will work on any glass teletype (like most BBSs), or if your PC emulation package includes VT100 or VT200 emulation, this also will suffice.

You can dial in through any of the following centers: East Coast, (215) 542-9458; Southwest, (818) 577-9100; and Northwest, (415) 873-2135. Have your name and subscriber number ready (refer to mailing label).

ARIS doesn't accept uploads, for viral reasons, and the only code available is the code that we have published.

Try it. A public forum is only effective if it is a loud and crowded place, full of people and ideas.

A handwritten signature in black ink, appearing to be 'D. Miller', written in a cursive style.

Across The Spectrum EMC Is Your Total Performance Solution

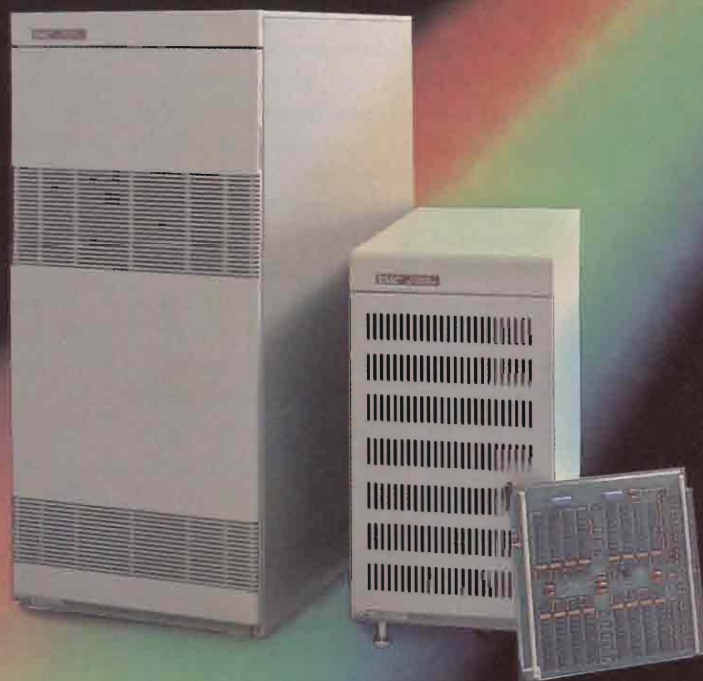

With high performing HXP-95X memory & Falcon Series disk subsystems for your HPPA computer.

It takes constant innovation to be a top performer. HP's new Spectrum Series systems add a whole new dimension to HP 3000 computing by enabling faster processing than ever before seen on classic HP 3000's.

EMC has been helping you maximize the performance of your HP system for years by providing reliable, high performing memory and disk products. Our success stems from innovative engineering and manufacturing excellence backed by worldwide support. EMC gives you all this at prices up to 20% less than HP's.

Spectrum users have found that greater amounts of memory and disk storage are required to reach peak performance with HPPA than was necessary with classic HP 3000's. In response to this need, EMC has developed a full line of products for the Spectrum Series. Now you can take advantage of EMC HXP-95X memory for your HP 3000 Series 950/955 and HP 9000 Series 850/855. And you can add Falcons, the fastest disk subsystems on the market, to your HP 3000 Series 925LX/925, 935, and 950/955, all at a cost that fits your budget.

EMC's HPPA compatible memory and Falcon disk subsystems are available immediately! Join the thousands of satisfied EMC customers who have turned to EMC for the solution to their performance bottlenecks.

Contact your local EMC representative today or call toll-free:
1-800-222-EMC2 ext. 2213.

EMC² The System
Enhancement Company.
HP is a registered trademark of Hewlett-Packard Company, Inc. EMC and Falcon are registered trademarks of EMC Corporation.

Setting The Standard In Europe



INDUSTRY WATCH

Peggy King

In the world of standards the term region means part of the world, and each region has a city that is home to the majority of that region's standards organizations.

In the North American region, the Washington D.C. area has the greatest concentration of standards organizations. In the Pacific Rim, Tokyo is the standards center and in Europe it's Geneva. Most of the Geneva-based organizations have offices on Rue de Verembè. Is it by coincidence, or by design, that Hewlett-Packard has its European headquarters in Geneva's Meyrin district not far from Rue de Verembè?

Whether or not HP chose the Geneva office because of its proximity to standards organizations, the location has been a convenient one and is becoming increasingly so.

HP plays an active role in at least six standards organizations based in Geneva and has a leadership role on a large number of committees within these organizations. Because there are HP divisions doing both R&D and manufacturing in Europe, Hewlett-Packard is an active participant in organizations that principally are comprised of European vendors.

The following is a brief rundown of the principal European standards groups in which HP participates. Four of these organizations, CCITT, IEC, ISO and X/Open are international in scope; the rest are open only to European companies and public agencies.

CCITT (International Telegraph and Telephone Consultative Committee) —

based in Geneva, founded in 1956. A United Nations treaty organization, the CCITT is the standards making body of the ITU (International Telecommunications Union). Membership is comprised of about 50 telecommunications agencies including the Soviet Union's agency. HP and approximately 135 other companies are non-voting members. Study groups of the CCITT make recommendations of standards for ISDN (Integrated Services Digital Network), message handling systems, network management and many other aspects of network communications.

IEC (International Electrotechnical Commission) — based in Geneva, organized in 1906. The IEC focuses on the hardware involved in electrical and electronic engineering. In recent years, the IEC has been an important organization for network vendors because it sets standards for connectors and cables. For example, the IEC is developing a standard for core fiber sizes of fiber optic cables and deciding which of 25 different power connectors used worldwide will become the international standard. There are over 80 technical committees including the technical committee for information technology that merged with a committee from ISO to become Joint Technical Committee 1 for Information Technology (JTC-1).

ISO (International Organization for Standardization) — based in Geneva, organized in 1947. ISO is the parent of OSI (Open Systems Interconnection), the group that published the OSI model for data communication in 1984 and created the profiles for standards-based networking such as MAP and TOP. The standards organization with the broadest scope, the ISO concerns itself with all industrial standards other than those governed by IEC. ISO's membership

consists of representative national organizations such as ANSI in the United States, AFNOR (Association Francaise de Normalization) in France and BSI (British Standards Institute).

JTC-1 — this joint technical committee between IEC and ISO was created in 1987 to handle standards for computing and telecommunications in areas when the technology for the two fields overlap. Don Loughry represented Hewlett-Packard at the national committee meetings for the United States group. **X/Open** — based in Reading, U. K., founded in 1984 and formally incorporated in 1987. X/Open is an independent non-profit consortium whose members (as of January 1989) are 19 international computer systems vendors. X/Open's mission is to endorse existing industry standards, and in areas where industry standards do not yet exist, X/Open works in cooperation with international standards organizations to create the needed standards.

X/Open coordinates the development of the Common Applications Environment (CAE), a set of integrated industry standards for applications development that are portable to all computers that comply with X/Open. Products that conform to the CAE and pass verification tests will display the X/Open logo on their exterior packaging and literature. The HP 9000 Series 800 family is among the first computers to carry the X/Open certification logo, and the HP 9000 Series 300 computers soon will display it as well.

Hewlett-Packard plays a key role in X/Open with Jim Bell as chairman of the board. HP's NLS (Native Language Support) received X/Open endorsement

Customize your own information center facility . . .

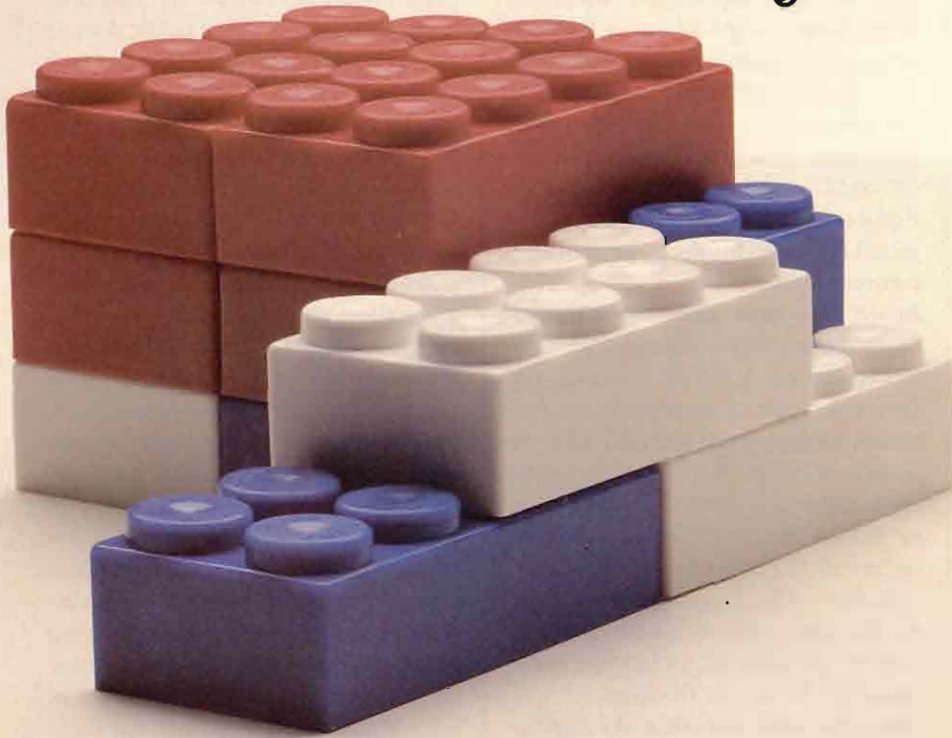

with the DataExpressSeries modular approach.



FOUNDATION: The core module of the DataExpressSeries links end users to their data on the HP3000. It accesses IMAGE™, KSAM, MPE and SD files to select, compute, sort, reformat and download data to PC applications.



STRUCTURE: The DataExpressSeries has a common menu and catalog structure. Full function key support provides even easier end user access to data. With Reflection™, downloads are automatic.

BUILDING: PowerHouse, Dictionary, RELATE and Omnidex Interfaces are available for enhanced access to your data. The DataCatalog option allows "views" of complex data structures to be defined for end users and security to be defined at the field value. The PrintLocal option gives end users access to their spooled output on their local printers.



In short, the DataExpressSeries is a simple, powerful information center solution to meet your needs and budget today. Since you can add options and

interfaces at any time, it provides a clear growth path to solving all your HP3000 data interchange needs in the future.

So, if you want to expand the power of your information center, call IMACS and ask how the DataExpressSeries can help you and your end users.

IMACS, helping HP3000 users since 1976.

DATAEXPRESS SERIES™



IMACS SYSTEMS CORPORATION
2825 Eastlake Avenue East, Suite 107
Seattle, Washington 98102

(206) 322-7700 (800) 87-IMACS

IMX SYSTEMS CORPORATION
London, England
(01) 541-0242
Telex: 51-944017

Calgary, Canada
(403) 259-2478

IMX INTERNATIONAL
Rotterdam, The Netherlands
(010) 483-1126

THE CASE FOR INSTALLING YOUR NEW PAYROLL IN THE 1st QUARTER

Conventional wisdom has it that a new payroll system has to be installed at the end of the year.

The problem is that there never seems to be enough time then. December is lost to the holidays and January's just too full with all of the tax stuff for you to bother with putting up a new system... even when you know full well it will save time in the future. It just doesn't get done. So you do it next year, etc, etc.

Well we'd like to respectfully suggest that maybe the end of the year isn't so great after all. It might just be that the end of the first quarter is the true "golden time" for payroll installation. The year end rush is over, there's time to give it the attention it deserves, and there aren't any long holidays messing things up. The only penalty, if you want to call it that, is that you have to enter one quarter's figures... but it's so easy to do with **THE PAYROLL** that your clerical people won't think it's a big deal at all.

Fortunately, you can still get a payroll system from Cort Directions for only \$1200-\$4250.

So do it now. Don't wait until "put-it-off time" again next year. Give us a call today. It's the right system at the right price at the right time.



65175 Cline Falls Road
Bend, Oregon 97701
(503) 388-3800

as the standard for internationalization of software products.

Preparing For 1992

One way that Europe is preparing for 1992 is to increase cooperation among vendors and public agencies, especially PTTs (Post, Telephone and Telegraph) throughout Europe. Many of Europe's standards organizations for information technology are member bodies of CEN/CENELEC, which is the association of European standards organizations. CENELEC is a separate organization for European electronics standards, but it joined forces with CEN to promote the member bodies.

ECMA (European Computer Manufacturers Association) — founded in 1959, headquartered in Geneva. ECMA, the first of the regional workshops, now includes multinational vendors like HP among its 32 member committees. HP's representative to ECMA is Dieter Gann in Boeblingen. HP also is active in technical committees of ECMA, especially TC32, communication, networks and systems interconnection, which is chaired by Cees Landing of the Grenoble Networks Division.

SPAG (Standards Promotion and Application Group) — incorporated in Belgium in 1984. SPAG is the European group for developing and promoting the use of the OSI model. Its sister organizations in other regions are COS (Corporation for Open Systems) in North America and POSI (Promoting Conference for OSI) in the Pacific Rim. The European group consists of 12 manufacturers who focus on the use of OSI standards for multivendor networking. HP's representative is David Rose, director of Strategic Alliances.

EWOS (European Workshop for Open Systems) — founded in Brussels in 1987. EWOS is a group formed to promote the development of the OSI profiles (MAP, TOP, GOSIP, etc.) and devise appropriate conformance tests.

ETSI (European Telecommunication Standards Institute) — created in 1987, will be headquartered in Sophia Antipolis, France (near Nice) beginning in April

1989. ETSI is taking over the standards-related work of CEPT, the European Cooperative for Postal and Telecommunications, whose members are PTTs such as Germany's Bundespost and France's Telecom.

Its mission is to produce the European Telecommunication Standards (ETS), which apply to the public domain as a counterpart to CEN/CENELEC's European norms, which apply to the private sector. These standards then become the official European standards.

Unified Market

The work that both international and regional European standards committees accomplish in the next four years will help to make the dream of a unified European Market become a reality.

During the next four years, Hewlett-Packard's expertise in national, regional and international standards enhances its position as a vendor to other multinational companies. For example, when Hertz International began setting up a wide area X.25 network across Europe, one compelling reason for choosing to have HP manage its European network was because of HP's experience with various standards bodies and its ability to negotiate with each country's PTT.

HP's work on standards committees made it easier to negotiate with government agencies and public utilities to procure the necessary telecommunications lines in each of the countries participating in the network.

With cooperation and lots of luck, four years from now a multinational company with plans to install a network can simply follow the guidelines published by the appropriate standards bodies rather than negotiating with PTTs and national bureaucracies throughout Europe.

Would you like to continue to see articles on this topic?
Circle on reader card
yes 324 no 323

CIRCLE 182 ON READER CARD

BackPack solves backup problems of all shapes and sizes.

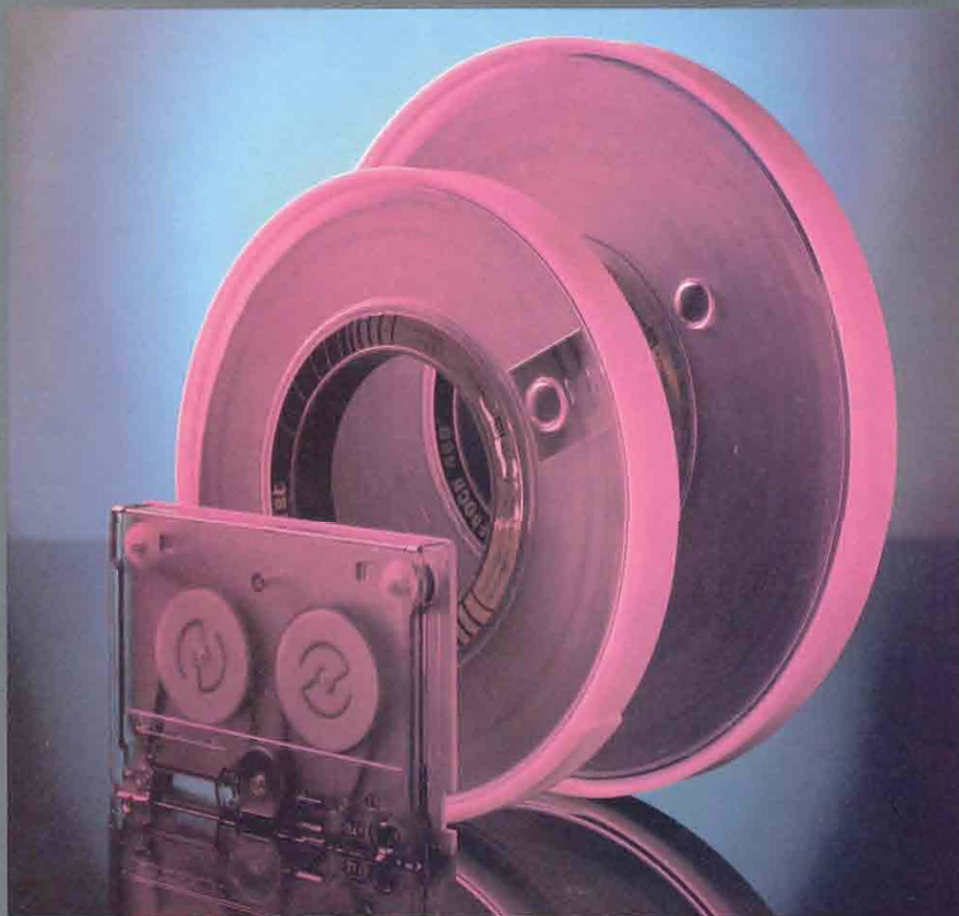

Whatever your HP 3000 configuration, there's a BackPack™ solution for you! For cartridge tape backup, there's low-cost **Micro BackPack**. Micro BackPack cuts backup time in half and doubles cartridge capacity—useful on any cartridge-based HP 3000, and a real lifesaver on a Micro LX or GX.

For MPE/V systems with reel-to-reel tape drives, the solution is **BackPack/V**. BackPack/V dramatically reduces backup time and tape usage, stores multiple databases on a single tapeset, offers integrated SYSDUMP and VALIDATE, and supports unattended backup.

For new MPE/XL sites, **BackPack/XL** is here! Because it uses the same tape format as BackPack/V, BackPack/XL can play a key role in migration and disaster recovery.

BackPack/XL is over twice as fast as HP's TRANSPORT mode, about 20% faster than native mode, and also supports operatorless backup.

BackPack can solve *your* backup problem. Call to order a free demo today!

Tymlabs Corporation • 811 Barton Springs Road • Austin, Texas 78704 U.S.A. • (512) 478-0611 • Telex 755820
Wick Hill Associates Ltd. • 42A-44 High Street • Egham, Surrey, U.K. TW20 9DP • 0784-38441 • Telex 268764
Tymlabs-APPIC • 123 Rue de Petit-Vaux • 91360 Epinay sur Orge, France • (1) 64-54-87-37 • Telex 803409
Megatec Pty., Ltd. • 2 Brunswick Road • Mitcham, Victoria 3132, Australia • (03) 874-3633 • Telex 152692
Infosistemas Financieros S.A. de C.V. • Bahía de Guantánamo 79 • 11300 México, D.F. • 254-3274 254-3284

HP Wins \$18 Million Contract From American Airlines

HP To Supply Computer Systems And Software For INTERAACT Project

American Airlines has selected Hewlett-Packard to supply computer systems for a strategic project that the companies believe will be the largest corporate information system of its kind outside of the computer industry.

As part of its INTERAACT project, American Airlines has signed a contract to purchase at least \$18 million worth of HP computer systems, software and service over the next three years.

INTERAACT will be an integrated office system that improves the productivity of American's business professionals by giving them quick and simple access to information from multiple resources, the ability to share information easily and better worldwide communications capability.

The INTERAACT system

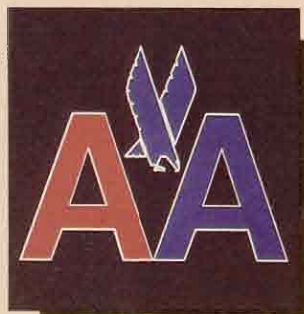

will include more than 135 HP 3000 business computers, HP NewWave software and the HP DeskManager electronic mail system. Initially, HP will supply HP 3000 Model 70 and HP Micro 3000GX systems. American plans to upgrade to HP Precision Architecture systems within the next year.

American will link the systems into a corporate network to provide electronic mail services to 14,000 professional employees at all American sites worldwide. The INTERAACT system also will connect to other vendors' systems, such as the IBM SNA environment.

IISI Becomes Preferred Consultant

Selected For Variety Of Experience With DISC Product Line

Innovative Information Systems Inc. (IISI) has been selected as a preferred consultant for DISC. IISI is a full-service systems consulting firm specializing in the HP 3000 system including Spectrum and its associated third-party products.

IISI was selected for its experience in the installation and implementation of the DISC product line including

Omnidex, Imsam and Omniquiz. IISI has integrated DISC software into COBOL, PowerHouse and other HP 3000 environments, including many custom development applications as well as third-party solutions.

Contact Innovative Information Systems Inc., 63 Nahatan St., Norwood, MA 02062; (617) 769-7611.

Circle 399 on reader card

HP To Manufacture Component Of LaserJet In U.S.

Boards To Be Built In Boise, Assembled In Japan

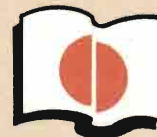

Hewlett-Packard has announced that it will manufacture a key component of the latest model of the HP LaserJet in the U.S.

Previously, the HP LaserJet line had been made in Japan by Canon Inc.

HP will build the for-

matter boards — the “intelligence” of a laser printer — for the HP LaserJet IID printer, the first desktop laser printer offering two-sided printing as a standard feature. The boards will be built in HP's Boise, Printer Division and shipped to Canon for assembly.



HP has announced three new PCs.

Three New Systems Increase Functionality Of HP Vectra

PCs Are Part Of Long-Term Strategy

Hewlett-Packard has announced three new personal computers for the HP Vectra personal computer family: two Intel80386-based desk-side models and a 12 MHz 80L286-based laptop PC.

The HP Vectra RS/20C and RS/25C (Intel80386 microprocessor) run at 20 and 25 MHz respectively. These two new PCs include a memory-cache system that allows them to execute programs up to 40 percent faster than the HP Vectra RS/16 and RS/20 PCs they replace.

The company said the new HP Vectra RS PCs are part of a long-term strategy to capture the market for PCs used in computer-aided design (CAD), computer-aided manufacturing (CAM) and multiuser systems.

The new HP Vectra RS PCs have a memory sub-

system that includes 32 KB of fast memory (cache memory) and an Intel82385 cache controller.

Memory cache improves the HP Vectra RS PCs' performance in business applications such as large spreadsheets and databases, as well as in CAD and multiuser systems.

The HP Vectra LS/12 laptop PC is designed for people who work in marketing, sales and service or others who travel often and require high performance in a lightweight, portable PC.

Each HP Vectra LS/12 laptop comes with 1 MB of RAM, a 3.5-inch, 1.44 MB flexible-disc drive a choice of either a 20- or 40-MB hard-disc drive and a detachable nicad battery pack.

The HP Vectra LS/12 laptop PC also comes with HP terminal emulation and HP disc-cache software.

The portable HP Vectra

CS PC has been reduced \$700 to \$1,795 for a system configured with 640 KB of memory and two 3.5-inch, 1.44-MB flexible disc drives.

The price has been reduced \$1,480 to \$2,195 for a system with 640 KB of memory, one flexible-disc drive and one 20-MB hard-disc drive.

AST Research Signs Purchase Agreement With Tandem Computers

Tandem To Distribute AST Desktop Computers

AST Research Inc. (Irvine, CA) has signed a worldwide original equipment manufacturer (OEM) purchase agreement with Tandem Computer Inc.

Tandem, under its own label, will distribute AST desktop computers as part of Tandem systems or networks. The contract is estimated at \$30 million.

The initial Tandem products will be based on the 20-MHz 80386-based AST Premium configurations. The agreement includes

AST's complete line of systems products, from 80286-based computers to the high-performance 25-MHz AST Premium/386.

Tandem also will configure the computer system with AST's memory/multifunction enhancement products and video display graphics boards.

For more information contact AST Inc., 2121 Alton Ave., Irvine, CA 92714; (714) 863-1333.

Circle 392 on reader card

HydroCAD Cut \$2,100 For IBM Users

HP Viper Board No Longer Required

The HydroCAD Stormwater Modeling System now will operate on an IBM AT or compatible using HT-BASIC from TransEra. This eliminates the need for the HP co-processor commonly known as the Viper Board and effectively reduces the AT price of HydroCAD by \$2,100. HT BASIC is included with HydroCAD for a total price of \$2,795.

HydroCAD integrates both the hydrology and hydraulics of stormwater analysis using a unique CAD

oriented design process. A watershed diagram is constructed on the screen so that all calculations automatically are sequenced. Originally designed for technical workstations, HydroCAD continues to be available on HP 9000 workstations for customers requiring maximum performance.

Contact Applied Microcomputer Systems, Page Hill Rd., Chocorua, NH 03817; (603) 323-8666.

Circle 393 on reader card

HP Adds Four VABs

Now Part Of Solutions Marketing Program

Hewlett-Packard has announced the admission of four value-added businesses (VABs) to its Solutions Marketing Program as new national accounts: Jonas & Erickson Software Technology, Revere Technology, RMS Business Systems Inc. and VTLS Inc.

The VABs market their software on HP minicomputers and PCs using HP's program to help market the solution to four industry market segments: construction, process manufacturing, distribution and library automation.

VABs are selected as national accounts on the basis of market focus and expertise and must qualify by adhering to HP's standards of performance in leveraged sales, customer satisfaction and support.

MacPrint Opens Macintosh World To LaserJet/DeskJet Printers

Users No Longer Restricted In Choice Of Printers

MacPrint now is available from Insight Development Corp. The new device management software package brings a variety of new printers to the service of Macintosh users who, until now, were restricted in their choice of printers.

MacPrint is capable of driving the LaserJet Series IID, LaserJet II, LaserJet 2000, LaserJet 500, LaserJet Plus and the DeskJet Printer from the Macintosh. The product also will run on any HP compatible laser printer. MacPrint can be used with the Macintosh Plus, Macintosh SE and Macintosh II.

MacPrint is installed as a Chooser level device using a supplied installer program and is operated with standard Macintosh printer dialog boxes. This makes it transparent to the user who

can send instructions to the printer in the manner described in Macintosh documentation and assures compatibility with all standard Macintosh software products.

The MacPrint Chooser shows each individual printer's features allowing the user to take full advantage of each printer's capabilities. MacPrint provides control for duplex printing, binding margins and cover pages.

Suggested retail price is \$149. A 30 day money-back-satisfaction guarantee is provided by Insight.

Contact Insight Development, 1024 Country Club Dr., Moraga, CA 94556; (415) 376-9500.

Circle 390 on reader card

American-Made Computers Lead The High-Speed Race



Tested On Solving Linear Equations Needing 700,000 Arithmetic Operations

Benchmark computer tests at the Department of Energy's Argonne National Laboratory indicate that American-made machines continue to lead in high-speed computing.

In a recent series of tests for speed in solving a set of linear equations, the top 10 performers were all American made. Nine of the 10 were Crays in various configurations and the other was an ETA 10-E made by Control Data Corp., Nippon Electric Co.'s NEC SX-2, believed by many to be the world's fastest computer, finished 12th in the test.

In all, 287 different configurations of about 100 dif-

ferent computer makes were tested on how fast they could solve identical sets of linear equations using Argonne's LINPACK software. The solution required approximately 700,000 arithmetic (addition and multiplication) operations.

Some 147 computer models — slightly more than half of the test group — were able to solve the test in less than one second. The machines tested ranged from multimillion dollar Cray supercomputers to ordinary desktop models.

Contact Argonne National Laboratory, 9700 South Cass Ave., Argonne, IL 60439; (312) 972-5580.

Circle 398 on reader card



HP PaintJet Now Runs With AutoShade

Produces Color Printing With Lifelike Images

Hewlett-Packard has announced that the HP PaintJet color-graphics printer now runs with AutoShade software from AutoDesk Inc. AutoShade allows users to generate 3D shaded images when used with AutoCAD, another AutoDesk PC-CAD software program.

Mechanical engineers, architects and designers using AutoCAD software and the HP PaintJet color-

graphics printer (\$1,395) now can produce low-cost, color-printing with lifelike, shaded images.

The AutoShade software package is \$500 and is available through authorized AutoDesk dealers and distributors. The HP PaintJet driver for AutoShade version 1.0 is available at no cost from dealers. The driver is included with AutoShade 2.0.

We're #1

At Unison, the focus—the only focus—is on providing innovative software solutions for automating data center management. This single-minded commitment has helped make us the market leader.

Today, our customer base includes many of the world's largest and most successful corporations. Companies such as Kodak, DuPont, Northern Telecom, Monsanto, Compaq, Rockwell, and Hewlett-Packard have incorporated Unison's software into their data center operations.

They've selected Unison because our products are as reliable and easy to use as they are powerful.

Only one company provides such high-level HP data center software and support: "For a permanent solution, it's Unison." 415 Clyde Ave., Mountain View, CA 94043, 415-968-7511

CIRCLE 141 ON READER CARD

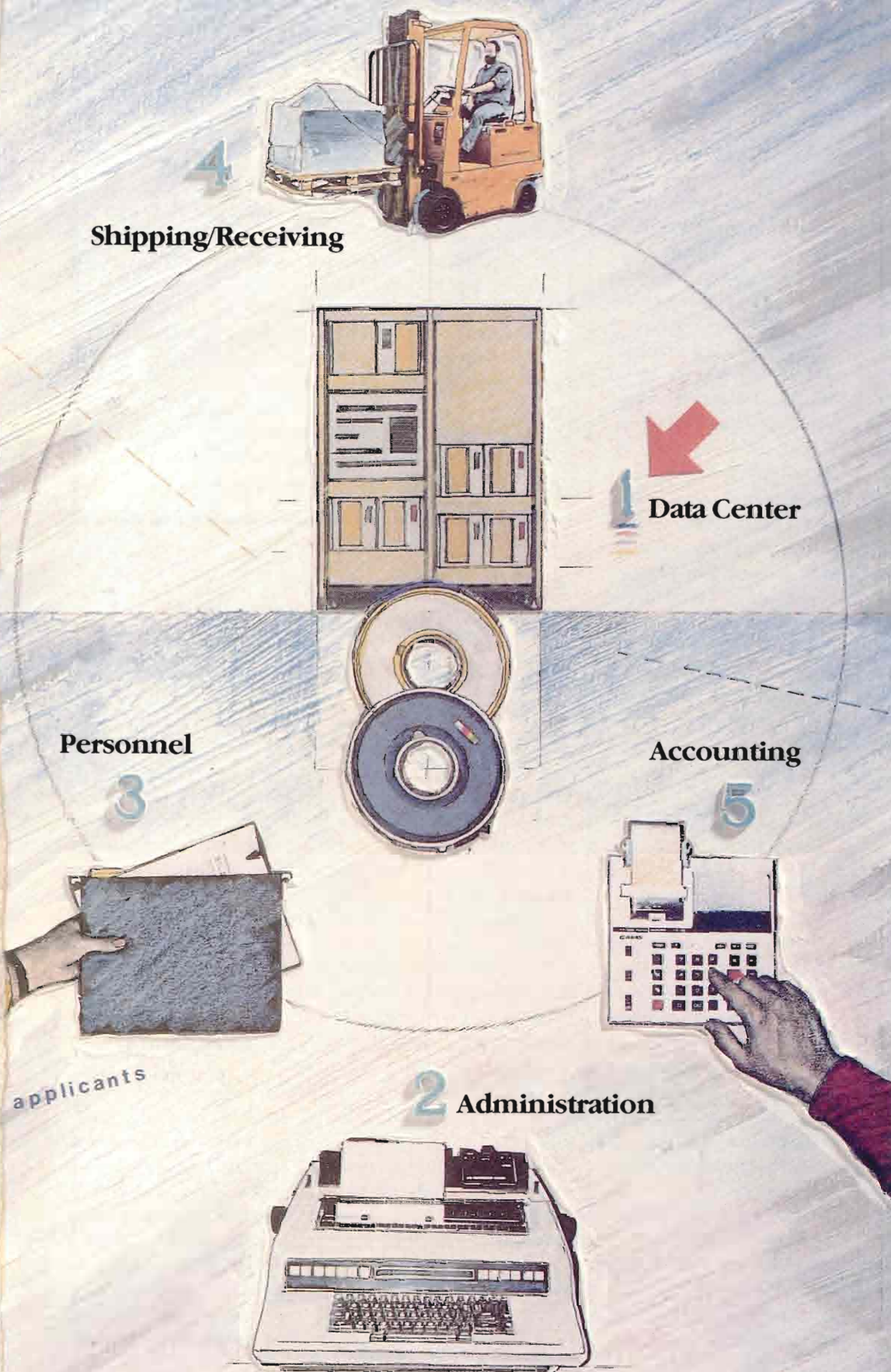

Unison
The data center management company
SOFTWARE

AT&T, HP Announce CPU Support Agreement

*HP Will Design And Market
A Real-Time DSP Emulator*



Hewlett-Packard and AT&T Microelectronics have announced a joint agreement to support and develop comprehensive development tools for the AT&T WE DSP32C digital-signal processor (DSP).

The new tools are estimated to be available sometime this year.

Under the agreement HP will design, market and sell a new real-time DSP emulator which emulates AT&T's DSP32C microchip. Samples of the chip are available now.

AT&T will provide integrated software-development tools, which are fully compatible with HP's new

emulator and personal or desktop computers. Both companies will share technical information to assist in the design of development tools.

HP's new DSP emulator is part of the HP 64700 emulator series that was introduced earlier this year. The series offers high integration using logic-analyzer-on-a-chip technology. Users will have a choice of operating the emulator from computers with either MS-DOS or HP-UX operating systems. HP-UX adheres to AT&T's UNIX System V Interface Definition Issue 2. AT&T will provide only the UNIX system port.

HP Acquires Eon, Maker Of LanProbe

*Eon Now Reports To HP's Colorado
Telecommunications Division*

Hewlett-Packard and Eon Systems Inc., have recently announced that HP has acquired Eon, a privately held maker of LanProbe, an intelligent, computer local area network (LAN) management system.

Eon (Cupertino, CA) now reports to HP's Colorado Telecommunications Division (CTD) and has been renamed the Intelligent Networks Operation (INO).

INO will develop and market distributed measurement systems that help prevent and analyze problems on data communication networks. CTD designs and makes data communication test instruments for manufacturers and users of data communication networks and equipment.

HP will begin marketing LanProbe, which analyzes Ethernet LANs. Primary customers are networked developers, installers and managers.

CaSaT, Codex Sign Technology Licensing Agreement

*CaSaT Will Assume Manufacturing,
Distribution And Service Rights*

CaSaT Technology Inc., (Amherst, NH) has signed a technology licensing agreement with Codex Corp. (Mansfield, MA) that permits CaSaT to assume the manufacturing, distribution and service rights of Codex Model 4303 Ethernet Transceiver and Codex Model 4320 Ethernet Hub.

Under the agreement CaSaT will manufacture and resell these two products to new customers as well as providing depot product repair service.

Products covered by the agreement are available immediately.

Contact CaSaT Technology Inc., 10 Northern Blvd., Amherst, NH 03031; (603) 880-1833.

Circle 396 on reader card

AST Improves Technical Bulletin Board



24-Hour Service Offers Better Support

AST Research announced that it has expanded its free 24-hour technical support bulletin board system (BBS) to notify customers of new information, offer quicker responses to general inquiries and provide users with easier access to software updates.

The BBS offers selected AST software updates including utility programs, software drivers and diagnostics, AST authorized service centers sorted by zip code, technical bulletins covering AST products, compatibility listings, new product announcements and microcomputer trade show schedules.

Accessible through asynchronous modems, the

BBS is available to any AST customer or potential customer using line speeds of 300, 1200 and 2400 baud.

The telephone number for the AST bulletin board system is (714) 852-1872.

For additional information, contact AST Research Inc., 2121 Alton Avenue, Irvine, CA 92714; (714) 863-1333.

Circle 392 on reader card

Note: If you have any questions regarding a Hewlett-Packard announcement mentioned in News & Trends, please contact the Hewlett-Packard sales office listed in the white pages of your telephone directory.

EasyReporter™

the ultimate in end-user computing

Finally! Computer software that is genuinely designed for use by personnel outside the d.p. dept.

Your users can:

- write reports
- do on-line inquiry screens
- download results to PC's
- turn their reports into graphs

... all, without programming

... all, with your tight control of the system.

EasyReporter is a fine complement to your POWERHOUSE, SPEEDWARE or 3GL environment that your users will appreciate.

To find out more about EasyReporter, the ultimate end-user computing tool contact us at:

(416) 678-1841 Marketing Dept.
7420 Airport Road
Suite 201
Mississauga, Ontario
L4T 4E5

In Europe: London (01) 828-1897

Infocentre Corporation

infocentre

CIRCLE 172 ON READER CARD

Ithaca Supports Apollo, HP, Silicon Graphics Workstations

Toolkit Based On Declarative Programming Interface

Ithaca Software, maker of HOOPS, a 3D graphics tool systems for personal computers and workstations, has announced support for Apollo, Hewlett-Packard and Silicon Graphics workstations. The 3D graphics toolkit is based on a declarative programming interface that simplifies the task of creating 2D or 3D technical applications.

The system is based around a hierarchical object-oriented graphics database. High-level commands control which objects in the database are displayed, where they are displayed and how they are rendered. This system eliminates the need to

specify hundreds of low-level procedural graphics commands.

HOOPS features fast hidden line/surface removal and multiple light source rendering. The new version now provides developers with a single graphics development system that is 100 percent portable across these supported platforms: Sun, Apollo, DEC, Silicon Graphics, HP, Macintosh II and 80286- and 80386-based workstations.

Contact Ithaca Software Inc., 902 W. Seneca St., Ithaca, NY 14850; (607) 273-3690.

Circle 397 on reader card

Neuron Data Offers Software Bridge

NEXPERT*SQL Will Link ORACLE And NEXPERT OBJECT

Neuron Data Inc., vendor of the expert system shell for commercial and industrial integration announced a software bridge between ORACLE for Macintosh and NEXPERT OBJECT called NEXPERT*SQL. NEXPERT OBJECT, a C-based expert system shell available on all standard hardware platforms, now offers Mac users the ability to dynamically map database

records into NEXPERT's object representation for intelligent processing. NEXPERT also links to ORACLE's Hyper*SQL, an enhancement to Apple's HyperCard application development environment.

For more information contact Neuron Data Inc., 444 High St., Palo Alto, CA 94301; (415) 321-4488.

Circle 391 on reader card

UW College Of Engineering To Receive HP Workstations

Contribution Worth \$5.5 Million

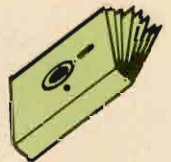

The College of Engineering at the University of Washington will receive \$5.5 million worth of computing equipment from Hewlett-Packard during the next three years. The contribution, university officials say, will make the engineering curriculum a model for other universities.

Under an agreement with HP, the college will

commit \$1.1 million to qualify for HP's \$4.4 million donation, which will equip the college with approximately 180 workstations for computer-aided engineering analysis and design.

Contact Greg Zick, UW College of Engineering, FH-10 University of Washington, Seattle, WA 98195; (206) 543-0340

Circle 395 on reader card

OCS Signs Corporate Agreement

HP To Utilize OCS/LIBRARIAN

Operations Control Systems (OCS) and HP have recently announced an agreement granting HP a corporate-wide licensing agreement for the OCS/LIBRARIAN software product.

The agreement allows HP to utilize OCS/LIBRARIAN within its internal data centers worldwide. OCS/LIBRARIAN functions include many features to improve the efficiency of the software development and maintenance cycle including: version control, source control, production integrity, release control, segregation of duties, automatic recompilation or applications, archiving, and scan and replace. The system functions with any programming language and with all file types.

Contact Operations Control Systems, 560 San Antonio Rd., Palo Alto, CA 94306; (415) 493-4122.

Circle 394 on reader card

Correction

On page 56 of the January 1989 issue the address and price given for NSD Inc's., *SpoolRescue* product was incorrect.

The correct address and price is:

NSD Inc.
1670 South Amphlett Blvd., Suite 103
San Mateo, CA 94402
(415) 573-5923
Price: \$2,500

CIRCLE 320 ON READER CARD

How Kelly unleashes HP performance.

It's a Kelly tradition. Taking HP system performance to the maximum. Cutting through the restrictions. Overcoming the limitations — whether posed by CPU, memory or I/O.

We've worked at it. Putting together solid HP system expertise — hardware, software and applications. Developing the tools. Delivering on promises. Establishing ourselves as "the HP performance people."

Who else would be first to ship *add-in memory for the new Spectrum-class systems*? 16-MB modules that get the best from that memory-hungry RISC-based HP Precision Architecture (HPPA). They're the first of various performance-boosting Spectrum-class products you can expect from Kelly.

And take our "classic" HP 3000

memory upgrades. The fastest available. With more board configurations than you'll find anywhere — from 1 to 16 MB. There's

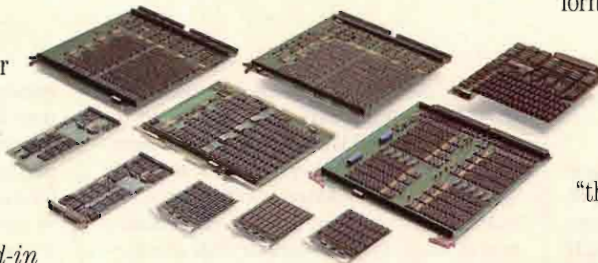

Kelly offers a broader line of HP-compatible memory products than anyone, including HP.

also our *XL/3000 RAMDISC* — up to 112 MB of plug-in solid-state disc — that boosts application productivity as much as 50%. Instant reads. Instant writes. With no added MPE overhead. And here again,

there's more to come.

A final point. When a Kelly product is ready, it's ready. Count on delivery. Performance. And reliability — attested by MTBFs exceeding 60 years, 20,000 units in the field and our Lifetime Memory Warranty.

Write, phone or FAX today. Learn more about how we've become "the HP performance people."

KELLY
COMPUTER SYSTEMS

1101 San Antonio Road
Mountain View, CA 94043
415/960-1010
Telex: 4931648 KELLY UI
Fax: 415/960-3474

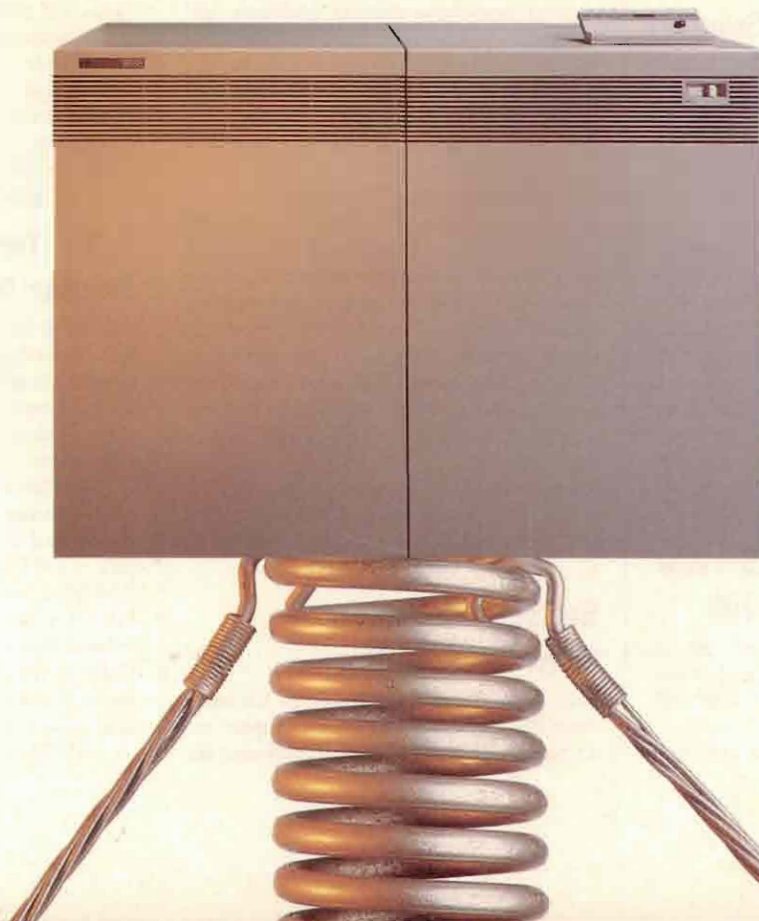

CIRCLE 173 ON READER CARD

ABACUS Releases SDC71 LIF Utilities

ABACUS, a division of Calculus Inc. has announced the release of the SDC71 LIF Utilities. This software runs on a PC under DOS and allows the user to transfer ASCII files between Hewlett-Packard and IBM-PC computers via diskette, making it easy to share data files between previously non-compatible systems. Full instructions and telephone support are included with each utility. Cost is \$250 per copy.

For more information, contact ABACUS, a division of Calculus Inc., 2929 — 4th Avenue South, Minneapolis, MN 55408; (612) 827-2689.

Circle 385 on reader card

Neuron Data Offers National Language Support

Neuron Data has released the Kanji version of NEXPERT OBJECT, a C-based expert system shell. NEXPERT OBJECT provides the open architecture and graphical user interface, plus the knowledge representation required to build commercial applications.

It is available for HP 9000 Series workstations and is being ported to other platforms. Current Japanese distributors include the Bechtel Groups' Tokyo subsidiary, Overseas Bechtel Inc., Nihon DEC, Hitachi Zosen, ABC Corp. and Asahikasei Information Systems. A fully translated Kanji version of the NEXPERT OBJECT manual also will be available.

Contact Neuron Data, 444 High Street, Palo Alto, CA 94301; (415) 321-4488.

Circle 384 on reader card

Bradley Ward's PMIS Now On HP 9000 Series 300

Bradley Ward Inc. (BWI) has released its Process Management and Information System (PMIS) software package on the HP 9000 Series 300.

Previously available on the HP 1000

A-series and HP 9000 Series 800 platforms, the full function PMIS now is featured on the entire line of HP technical computers.

PMIS is a turnkey solution that addresses such applications as cell control and real-time and historic process information management. Features include: data communications operator interfaces, interactive menu-driven and file-driven utilities, a data export facility and more.

For more information, contact BWI, 5 Dunwoody Park, Suite 115, Atlanta, GA 30338; (404) 396-4292.

Circle 383 on reader card

Peripherals Announces Magnetic Computer Tape

Peripherals (Costa Mesa, CA) has introduced a new magnetic computer tape designed to combat long-term storage problems and error growth caused by stretching, cinching and contamination. The tape is interchangeable from 6250 BPI, 1600 BPI and 800 BPI and meets all amplitude specifications for the three recorded densities, assuring greater data integrity.

Archival Storage Tape is tested at a 35 percent clipping level. Error criteria at 6250 BPI is zero errors. Each reel is run through an anti-static eliminator to help eliminate contaminants from clinging to the recording surface. Archival Storage Tape comes in lengths of 600, 1200, 2400 and 3600 feet.

Archival Storage Tape is used to address the mounting problems users have when trying to recall data from storage and disaster recovery.

Contact Ronald H. Carboy, Peripherals 1363 Logan Ave., Costa Mesa, CA 92626; (714) 540-4925, (408) 995-5384, or (800) 468-6888.

Circle 366 on reader card

Softscience Releases Convenience Plus

Softscience Corp. has released its Convenience Plus UNIX Front End, a graphic interface to UNIX. The program performs file

management, popular operating system commands and administrative functions graphically and with minimal typing and overhead. Convenience Plus produces a Graphic Tree Image(s) of file storage that can be traversed via arrow keys or mouse. All interaction is visual, just point and shoot. Movable and adjustable windows can be called to display and interact with a graphic image of files storage, a list of files, running applications and/or a file status information display.

The application features a Hex Editor/Viewer, graphic functions for adding/deleting a user and setting skeleton files library, a incremental search function to find files, functions to copy/ type/ link/ remove/ rename/ duplicate stamp/ print/ move/ edit/ pipe/ backup/ files in groups or alone and across directories, graphically create-delete directories and more.

Compatible with Sun, AT&T and ports being made to other UNIX systems. It has a retail cost of \$399.

For further information, contact Softscience Corp., Box 42905, Tucson, AZ 85733-2905; (602) 326-4679.

Circle 381 on reader card

AMT Turns Accel-500 Printer Into Printer/Plotter

Advanced Matrix Technology Inc. (AMT) has released AMTplot, a DOS-compatible program that reads Hewlett-Packard Graphics Language (HP-GL) plot files and prints them on the Accel-500, AMT's high-resolution, color printer.

AMTplot supports the 16-inch wide (C-size) printing capability of the Accel-500 printer and all of the graphics resolutions — 60V x 60H dpi up to 240V x 480H dpi. AMTplot reads and converts complex HP-GL plots quickly. Processing and conversion time averages less than two minutes. Other features include a print spooler, multiple copy ability and automatic data compression of output files.

AMTplot can enhance the HP-GL plot

with special capabilities such as auto rotation, horizontal and vertical scaling, image translation, erase and clear pens and two internal fonts.

The program supports a coordinate space of 15 miles in both the positive and negative X and Y directions. Since the printer's carriage is somewhat shorter, the program can clip plots into pieces to fit on any size page.

AMTplot has been tested with over 50 CAD and graphics packages, including AutoCAD, CADkey, VersaCAD Advanced and Lotus 1-2-3. AMTplot is currently available for \$195.

For more information, contact AMT, 765 Flynn Rd., Camarillo, CA 93010; (805) 499-8741.

Circle 380 on reader card

Keithley Offers New IEEE Data Acquisition System

Keithley Instruments has developed a new IEEE-488 data acquisition mainframe that connects to any computer with an IEEE port.

The 556 Measurement and Control System is an external data acquisition mainframe that accepts up to 10 plug-in data acquisition cards. When configured with Keithley's AMM2 analog/digital converter card, the 556

is capable of 16-bit, 6000 samples/second data acquisition over the IEEE bus.

With its IEEE connectivity, the 556 allows users to conduct analysis, acquisition and test control through any personal computer, particularly Macintosh PCs, but also including workstations from DEC and Sun Microsystems, controllers from Hewlett-Packard and NEC computers.

Keithley's Model 556 data acquisition system, with high speed/resolution capability, is configured for about \$3,000.

For more information contact Keithley Instruments, 28775 Aurora Road, Cleveland, OH 44139; (800) 552-1115.

Circle 379 on reader card

HP Introduces HP 64000 AxCASE Solutions

Hewlett-Packard has introduced its HP 64000 AxCASE solutions for Embedded Microprocessors, a family of cross software development tools that include Advanced C Cross Compilers, Debug Systems and Basis Branch Analyzers.

Currently the new HP 64000 AxCASE products support the Motorola MC68000, 68010, 68008 and 68020 microprocessors. An optimizing Advanced C Cross Compiler and Basis Branch Analyzer are available for

the Intel 8086 microprocessor family. Other support is planned for the near future.

The latest additions to the HP 64000-UX Microprocessor Development Environment runs on HP 9000 Series 300 and Series 800 computers.

HP 64000-UX covers the development lifecycle for over 40 microprocessors. Current tools support analysis, design, software construction, software integration, hardware/software integration, release and maintenance phases of the development process.

Integration within the HP-UX operating systems allows such benefits as the use of HP-UX facilities for customizing and enhancing development tools.

HP 64000-UX also maintains open, standard interfaces. HP's support of industry standards such as ARPA and Berkeley networking services, NFS and X Window System make it possible to integrate other vendors' tools into the HP 64000-UX environment.

ATA Releases Quality Tracking System

Automated Technology Associates (ATA) (Indianapolis, IN) has released its Quality Tracking System, (QTS) on the HP 9000 Series 800 and the HP 1000 (A Series).

QTS is a product-oriented quality system for floor-level tracking and historical retrieval of quality information by serial, part or lot number. Products are characterized by serial identification and high value per unit and typically incur high costs for rework, scrap or warranty repairs.

QTS is an open system product with two primary modules: QTS Floor and QTS History. These modules may be mixed and matched with other ATA software systems or customer systems to provide the specific combination of capabilities needed to meet your quality tracking and reporting requirements. QTS is available for immediate shipment on both the HP 9000 Series 800 and HP 1000 versions.

For more information contact ATA, 9000 Keystone Crossing, Suite 1000, Indianapolis, IN 46240; (317) 573-9000.

Circle 377 on reader card

DISC Announces Enhancements To OMNIDEX

Dynamic Information Systems Corp. (DISC) has announced enhancements to its

*The 556
Measurement
and Control
System
developed
by Keithley.*



OMNIDEX database management software released under version 2.03.

Features include native language support (NLS) supporting the Roman 8 character set, the elimination of the 12,000 qualifying record limit on range retrievals, the ability to make selections across domains (also known as "multifind"), phonetic keyword searching (soundex) and expanded programming language support, including Fortran 77, Business Basic, RPG and Protos.

The new release has been distributed to all DISC distributors, consultants and VARS, as well as selected beta customers and will be shipped to all current OMNIDEX customers at the time of their maintenance contract renewal.

Contact DISC, 910 Fifteenth Street, Suite 640, Denver, CO 80202; (303) 893-0335.

Circle 376 on reader card

RGB's New Multi Input Video Converter

RGB Technology has announced its new multi-input video scan converter. The model 1400M converts high resolution computer graphics to television format (NTSC or PAL), with up to 16 user selectable workstation inputs.

The RGB/Videolink 1400M supports all high-resolution workstations, including all current models from Sun, Apollo, Tektronix,

DEC, Silicon Graphics and IBM with pixel resolutions of 1024x768 to 1280x1024 (45-75 kHz). Sixteen user selectable presets are available at the touch of a button.

With the model 1400M, a company with a variety of workstations can address all of its scan conversion requirements.

The 1400M is the latest product in RGB's line of video scan converters that incorporate full 24-bit color processing, real-time operation and sophisticated flicker filtering. Essentially a dedicated image processor, the RGB/Videolink accepts full screen, noninterlaced RGB input, provides genlock, sync generation and encoding to output television (NTSC or PAL video.) Complete conversion is accomplished in real-time. The RGB/Videolink requires no software modification and does not affect performance of the workstation or its RGB monitor. A proprietary filter eliminates the problem of flicker in the interlaced television output. Contact RGB Technology, 2550 Ninth St., Suite 114, Berkeley, CA 94710; (415) 848-0180.

Circle 375 on reader card

Graphicus Announces Availability Of Q+

Graphicus Inc. (Kirkland, WA) has introduced Graphicus Q+, a statistical quality control (SQC) application. The interactive

program executes on the HP 1000A and 9000 Series computers. The product offers a range of capability in statistical analysis and graphical display required in manufacturing.

The exact functionality requested by the Q+ customer can be custom configured by Graphicus and accessed through operator choices from a menu-style interface. The capability of Graphicus Q+ can be expanded to satisfy evolving needs, such as advanced statistics, multivariate statistics and database interfaces.

Companies pursuing industrial automation strategies now may choose between the Graphicus Q+ custom implementation and building their own system using Graphicus' Grafit, Statit and Drawit tools.

Prices depend upon the intended HP computer. A Graphicus Q+ installation on a 9000/825 ranges from \$20,000 to \$30,000. Individual tools may be licensed for between \$3,000 and \$10,000.

For additional information, contact Graphicus, 150 Lake Street, Suite 206, Kirkland, WA 98033; (206) 828-4691.

Circle 378 on reader card

Toshiba Introduces New 2400 BPS Modem Line

Toshiba America's Informational Systems Division has announced a new line of optional internal modems for its portable personal computers, featuring 2400 bits-per-second (bps) transmission speed.

The Hayes-compatible modems feature the faster speed, and for Toshiba's battery powered portables PCs, lower power consumption for maximum battery life. Automatic power on/off switching further reduces power consumption.

The T2400A, priced at \$399, is designed to fit the Toshiba expansion slot in the T1100 PLUS, T1200 series, T1600, T3100, T3100/20, T3100e, T5100 and T5200 portables PCs.

For its smallest PC, the T1000, Toshiba provides the T2400B at a cost of \$399. Contact Toshiba America Inc., Information Systems Division, 9740 Irvine Blvd., Irvine, CA 92718; (800) 457-7777 or (714) 583-3000.

Circle 374 on reader card

FILESTAR — A Multifile Utility For HP 3000

Orion Systems Technology Inc. has announced Version B.03 of FILESTAR multifile utility for the HP 3000.

Continued on page 88.

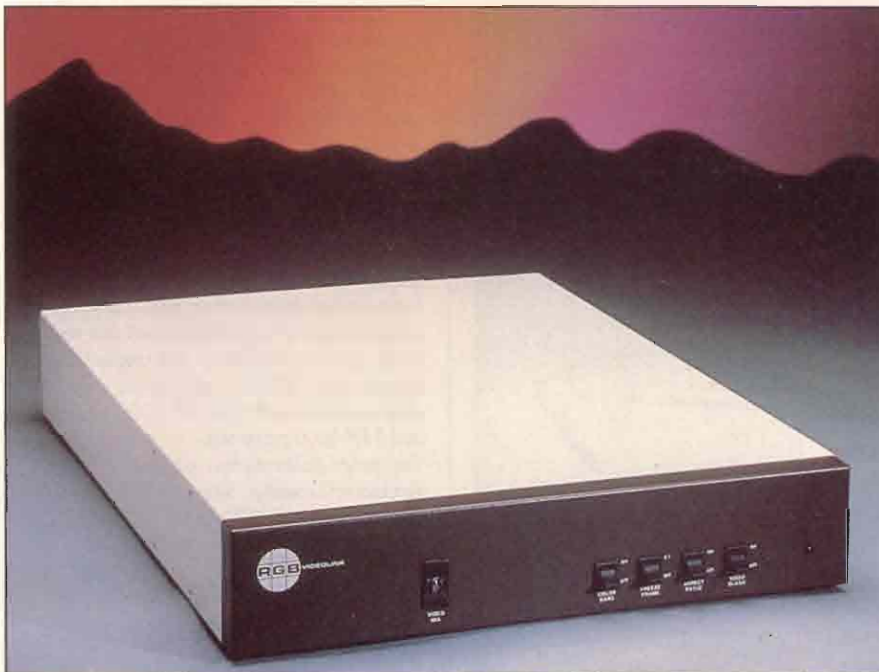

RGB announces new multi input video scan converter.

Would You Buy Your Watch a Piece At a Time?

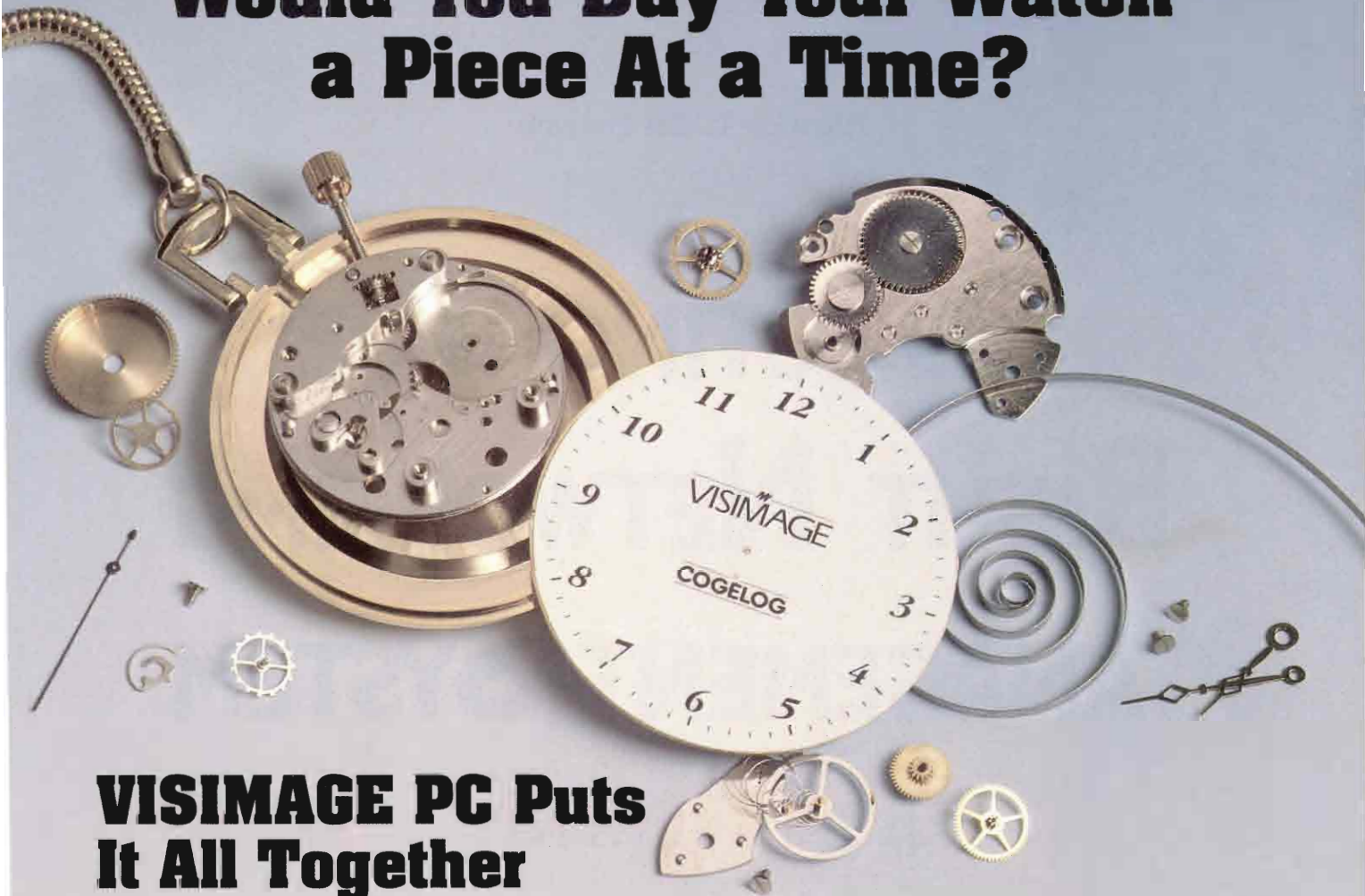

VISIMAGE PC Puts It All Together



Report Writing

Simple and detailed reports are easy to create. The unique painting facility allows users to draw the report layout directly on the screen. VISIMAGE PC provides all the functions of a powerful report writer, simply designed for the end user.



PC/HP3000 Access

VISIMAGE PC includes a new communication package designed by Walker Richer and Quinn that allows you to access HP3000 data using any PC network. Users have access to IMAGE databases, KSAM, MPE and SD files. VISIMAGE comes complete with interfaces to OMNIDEX, DICTIONARY/3000 and POWERHOUSE dictionary. Sophisticated features allow the DP department to retain total control over security, confidentiality and system resource usage.



On-line Tutorial

VISIMAGE PC's ease of use is enhanced by a tutorial mode for novice users. Pop-up windows guide the users through each step. Very quickly you will become an expert at reporting and downloading data.



Downloading

Your HP3000 data can be automatically downloaded to the PC. All the major PC formats are supported, making your data available to spreadsheets, word processing and other productivity tools (e.g. LOTUS 1-2-3, DBASE III, etc.).



Windows

VISIMAGE PC combines the power of VISIMAGE with the flexibility of a window environment. Pull-down menus and pop-up windows give the user easy access to timely information. Use the mouse to design the layout of your report or "click" the items you want to select. VISIMAGE PC runs on all IBM compatibles, using MS-DOS or OS/2, with a basic configuration.

VISIMAGE PC puts all the pieces together giving users a complete solution. Call today for a demo diskette to learn how VISIMAGE PC can benefit you and your company.

VITAL
Soft
A COGELOG COMPANY

Outside California Only, Call

1-800-VITALSOFT

1913 Old Middlefield Way, Suite E,
Mountain View, CA 94043 (415) 955-4494

LOTUS 1-2-3 is a trademark of Lotus Development Corp.
DBASE III is a trademark of Ashton-Tate
POWERHOUSE is a trademark of COGNOS
OMNIDEX is a trademark of DISC
VISIMAGE is a trademark of COGELOG.

Migration To OSI Protocols

SELECTING THE RIGHT NETWORKING MANAGEMENT SYSTEM

[BY SHARON FISHER]

Everyone agrees that networks need to be managed. The problem is, not everyone agrees on how.

Some computer companies maintain that users should use proprietary methods. For example, IBM says that computer networks should be managed with its Netview network management system. But this method has a couple of drawbacks. First, all the other computer companies must agree to support another vendor's product, agree which other product to support, and then change their products whenever that vendor changes. Second, some users and vendors are leery of trusting one vendor's word on the status of the network, especially when the vendor sells hardware and software as well as network management products.

There is nothing stopping the network management vendor from pointing to the other vendors' products as the source of network problems. Consequently, many vendors — including Hewlett-Packard — have agreed that the best way to manage a network is through a standard network management method defined by an independent organization. That way, all the vendors' computers can communicate, but no one vendor has an advantage over the other vendors.

NETWORKING ITSELF HAS undergone a similar change over the past few years. Where companies used to have proprietary communications methods — which worked fine as long as users only needed to connect computers from one vendor — they have since moved to standard methods of communication. This allows users to set up net-

works made up of computers from a number of vendors. Not surprisingly, the same organizations are involved in setting up both networking and network management standards.

Unfortunately, there are two schools of thought about networking methods — and therefore of network management systems. One method is Open Systems Interconnection (OSI), which is being developed by a number of vendors under the auspices

of the International Standards Organization (ISO). The other is Transmission Control Protocol/Internet Protocol (TCP/IP), which has been in use for 15 years and has an increasing installed base.

It's expected that users eventually will migrate from products based on TCP/IP protocols to products based on OSI protocols because OSI protocols have more capabilities and are more flexible. However, the process will take several years. OSI and TCP/IP each has its own network management method.

In the case of OSI, the method is Common Management Information Protocol (CMIP), while in the case of TCP/IP, the method is Simple Network Management Protocol (SNMP). In the same way that TCP/IP protocols eventually will give way to OSI protocols, SNMP eventually will give way to CMIP. In fact, SNMP protocols eventually will migrate to CMIP protocols, even on TCP/IP networks.

Skiping Over SNMP

WITH THIS IN MIND, a number of vendors — including HP — are skipping over the SNMP stage entirely. Otherwise, they'll need to make two major development efforts within a few years. Instead, they intend to develop products using CMIP protocols that can manage both OSI and TCP/IP networks that have the added advantage of being able to help users as they migrate gradually

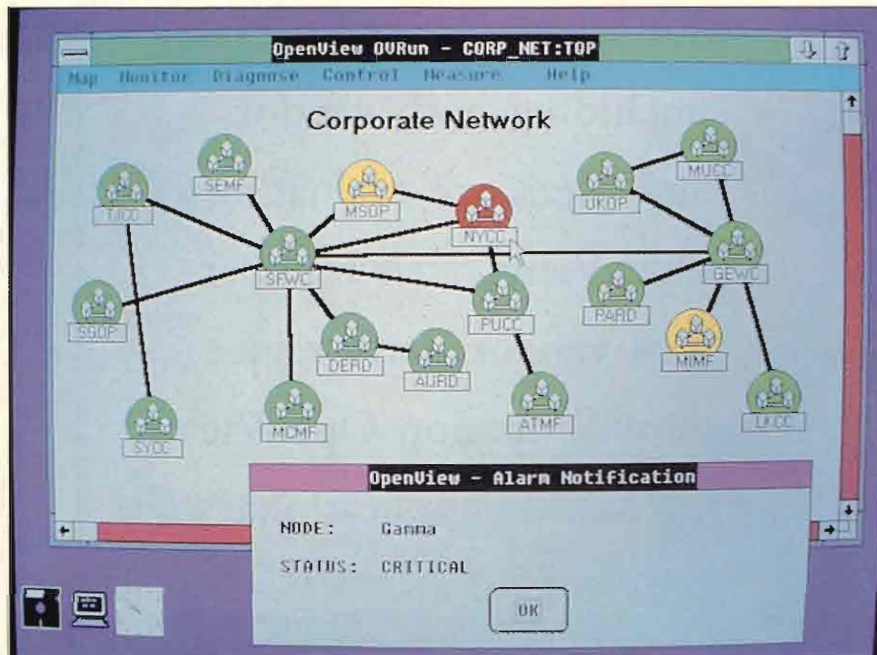

Announced in March 1988, HP OpenView provides network managers with windows into local and remote multivendor networks, using consistent colors and icons to alert managers of impending or critical network-management problems.

from TCP/IP to OSI. However, products based on SNMP protocols are available now, while the first products based on CMIP protocols aren't expected until later this year.

The Third TCP/IP Interoperability Conference, held last September in Santa Clara, CA, featured two competing groups of vendors demonstrating network management methods based on SNMP and CMIP. While about a dozen vendors demonstrated software based on

CMIP, none had products that were ready to ship.

HP, like most of the other vendors, featured a demonstration and said its CMIP products would ship sometime this year, but wouldn't specify when. "We want to base our network management on OSI standards," says Jackye Churchill, marketing manager for HP's Information Networks Group, adding "SNMP is a tangent to where we want to pool our resources."

Network Management Forum Resolves Ambiguities

BECAUSE NOT ALL of the OSI network management protocols have been defined, HP's OpenView product addresses issues that aren't yet determined by the standards-making bodies. Consequently, in 1988, HP helped form the OSI Network Management Forum, which is intended to help vendors develop OSI network management products that can work together. According to Churchill, in some cases, the standards that do exist have ambiguities. One of the tasks of the Network Management Forum is to resolve such ambiguities so two vendors don't end up taking different interpretations of the standard and ending up with incompatible products.

OpenView, HP's network management strategy, was announced in March, 1988. It consists of a number of products,

such as:

■ **HP OpenView Status and Diagnostic Monitor** software for the HP 3000, which monitors the status of remote HP 3000s.

■ **HP OpenView Performance Monitor** software for the HP 3000, which collects network performance information.

■ **HP OpenView Network Command Interpreter** software for the HP 3000, which, when used with OPT/3000, allows a network manager to execute

commands and programs remotely.

■ **HP OpenView ITIMS Manager** software, which performs centralized line analysis and fault isolation for telecommunications lines.

■ **HP OpenView Bridge Monitor** software, which allows a LAN manager to manage network bridges within a company facility from a single workstation.

For users who have IBM systems running the Netview network management program, OpenView can send alarm and event information to Netview applications. In addition, HP says users eventually will be able to access Netview network management information from the OpenView console. Similarly, HP may work with third party vendors to allow OpenView to accept network management data from SNMP protocols, and support for CMIP protocols will be incorporated into HP's OpenView products sometime this year.

OpenView's User Interface

ANOTHER WAY HP HOPES to differentiate OpenView from other vendors' network management products is through its user interface. "The graphical interface is one thing that [companies] have seen differentiating us from IBM's Netview," Churchill says.

A Microsoft windows-based program called OpenView Windows, which makes use of HP's NewWave development environment, runs on an HP Vectra PC. This product, which HP says is the cornerstone of OpenView, displays a network topology map and features menus by which network managers can execute application commands. The product integrates network management information from multiple vendors using a common set of symbols, colors and windows.

In a further attempt to make OpenView easier to use, it

More than 100 companies, including both vendors and users, are evaluating OpenView . . . A number of vendors have said they will develop OpenView Windows applications.

includes on-line help facilities. The colors of the map also help the manager determine the status of various network devices. For example, when a device goes down, it turns red. At present, OpenView Windows runs on DOS. However, both UNIX and OS/2 versions will be available this year.

More than 100 companies, including both vendors and users, are evaluating OpenView. HP is selling an OpenView Windows

Developers Kit which consists of a set of tools to help vendors develop OpenView Windows applications. The tools include software libraries and templates, programming software tools, context-sensitive on-line help, documentation and guidelines for integration. A number of vendors have said they will develop OpenView applications, including FiberCom Corp. (Roanoke, Virginia), Jutland Telephone Co. (Denmark), Microtronix Systems Ltd. (Ontario, Canada), Telindus (Brussels, Belgium) and Ungermann-Bass Inc. (Santa Clara, California).

Several of the vendors wouldn't say what products they plan to develop using OpenView, although most of them will be shipping products in the first half of this year.

FIBERCOM IS USING OPENVIEW to provide a consistent interface for users across its Fiber Distributed Data Interface (FDDI) and Ethernet communications product line. Microtronix is using OpenView to control its public and private X.25 wide-area network devices. Moreover, with tools from HP, Microtronix was able to demonstrate its product in just two months. Telindus, which makes modems, multiplexers and X.25 switches, is using OpenView to develop an easy-to-use graphical interface for its products.

Network management is as important to networks as utilities such as hard-disc managers are to single computers. Users who don't yet have a network management set up should look carefully at this area when doing their planning. —Sharon Fisher is a San Francisco-based freelance writer specializing in communications.

Would you like to continue to see articles on this topic?
Circle on reader card
yes 346 no 345

Call For Prize Winning Papers Win Up To \$1,000!

Here's an opportunity to share your prize winning, HP-computing solution through the pages of *HP Professional* and win up to **\$1,000** in the process.

The editors at *HP Professional* would like to hear from you. If you've successfully overcome any major computer problems in your HP shop, we'd like to know what the problem was and the steps you took to solve it. Or, if you've recently made some major decisions that significantly improved your computing operation, we'd like to hear about that too.

Below are some suggested topics:

- *maintaining applications across a distributed computing environment*
- *speeding up system response time*
- *building HP 3000 applications*
- *connecting your HP 3000 to a LAN*
- *using your HP 3000 in a multivendor environment*
- *tracking/analyzing/improving HP 3000 system performance*
- *porting code, data and/or applications onto a Spectrum. All advanced conversion issues are welcome.*
- *graphically displaying business data that resides on the HP 3000*
- *preparing your computer room environment for an HP 3000*

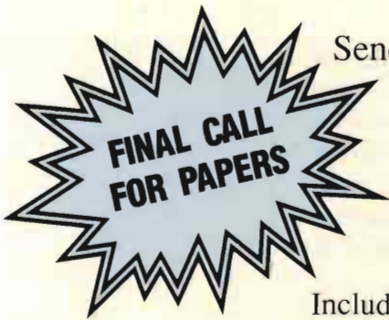

Send a **200-500 word outline** describing your paper to:

Linda Dibiasio
Executive Editor
HP Professional
921 Bethlehem Pike
Spring House, PA 19477

Include your name, address, company and a daytime phone number.

This call for papers is open to anyone active in HP computing.

Deadline: March 1, 1989

Winners will be notified by mail. Prizes are:

1st Prize	—	\$1,000
2nd Prize	—	\$750
3rd Prize	—	\$500

Can OSI And TOP/IP Coexist?

Map 3.0 For Factory LANs: Migration Or Coexistence?

[Peggy King]

Hewlett-Packard's initial set of products based on Open Systems Interconnect (OSI) standards are MAP products for computer integrated manufacturing (CIM) environments. MAP, the Manufacturing Application Protocol promoted by GM, Boeing and other automotive and aerospace companies, is an emerging standard for local area networks (LANs) in factories.

Why has HP chosen to focus on MAP rather than Technical Office Protocol (TOP), the OSI specification designed for engineering and office networks, or GOSIP, the U.S. government's implementation of OSI, which is now a requirement for government contracts involving networked systems?

"HP saw the need for MAP and has put together a structure to meet the need. No other vendor has had a standards program in place as long as we have," says Paul Accampo, MAP products manager.

In 1984, Hewlett-Packard became involved with MAP as a founding member of the MAP Users Group (MAP 1.0). In 1985, HP participated in the first functional implementation of MAP at GM, the 2.0 pilot line and the demonstration of MAP 2.1 at Autofact '85. At Ford, HP participated in a 2.1 pilot program in 1986 and introduced a MAP 2.1 product with the new HP 9000, Series 800 machines used as hosts. Last May at the Enterprise Networking Event in Baltimore, the company announced a line of MAP 3.0 products that will become available in phases throughout 1989.

Currently, the market for MAP networking is strongest in the automotive and defense industries and other job shop environments. However, there are indications

that batch industries such as food processing and continuous processing industries such as chemical plants and oil refineries will turn to MAP implementations in the coming years. Hewlett-Packard is positioned to provide solutions for all types of manufacturing environments. An instrument product, the MAP Protocol Analyzer monitors network traffic in MAP environments with equipment from a variety of vendors.

Industrial automation customers want a networking vendor with a commitment to MAP as well as an understanding of the multivendor environment of an automated factory. Traditionally, HP has focused a significant portion of its computer business on manufacturing environments. The HP 1000 has remained a popular choice for cell controllers, the number of HP 3000s used as host computers in industrial networks is second only to the number of DEC VAXs, and now HP is providing software products and consulting to promote the use of multiuser HP 9000, Series 800s as host computers. Multivendor MAP 3.0 networking is the next step in providing a total solution for industrial automation environments.

HP Jumps Ahead

IN SOME WAYS, HP HAS jumped ahead of its market in offering a total implementation of MAP 3.0. Although it is the emerging standard, many of HP's customers recently have implemented networks based on the de facto standard that usually is referred to as TCP/IP or the DoD Internet Suite of Protocols. Through layer 4, TCP/IP architecture is equivalent to the OSI architecture. (See box for an overview of the seven layer model.)

HP refers to the application protocols that were developed by the Department of Defense as ARPA Services and reserves the term TCP/IP (Transmission Control Protocol/Internet Protocol) for protocols that correspond to level three (IP) and level four (TCP) of the OSI model. From 1980 until the GOSIP mandate in 1988, the U.S. government mandated that all government networks implement the Internet Protocols. As of January 1989, there were 160 vendors supporting TCP/IP protocols and/or offering ARPA services to applications at the user level. The Wollongong Group (Palo Alto, CA) heads this list of vendors with a product line that offers TCP/IP networking for nine types of machines including the HP 3000 with MPE V and the HP 9000 Series 500.

Both HP and The Wollongong Group offer customers a transition path from Internet Protocols to MAP/OSI, but they have different views about how much of the network should be changed in order to incorporate MAP 3.0 applications. For customers who already have implemented standards-based networking with the Internet Protocols, HP advocates a dual transport layer (also called a stack) placed over a common physical link that will support TCP/IP transport layers. Dual stacks are possible with 802.4 networks (broadband LANs) as

long as there is a juncture at the top of the physical layer. Common 802.2 services at the link layer apply to both OSI and TCP/IP stacks.

Coexistence

BECAUSE THERE ARE VERY few factories that run on only one network, LANs with MAP 3.0 will need to coexist with other LANs for production engineering, inventory, shipping and receiving and interfaces to factory floor devices. According to Accampo, HP's strategy for helping customers migrate from TCP/IP and ARPA Services to OSI-based protocols and MAP 3.0 is to "preserve existing networks and wiring, offer expanded networks with new application features and to provide new applications that can talk to either ARPA or MAP."

HP's solution for factory floor LANs that need to talk to ARPA (for example, area managers that communicate with the engineering LAN) is a full implementation of OSI that coexists with the existing TCP/IP protocols. The new OSI Express from Roseville Networks Division implements layers one through six and the ACSE portion of the applications layer on a VLSI card (see box for a definition of ASCE). With OSI Express most of the processing is offloaded from the host, freeing the host computer to process the TCP/IP protocols and ARPA services. This card is designed for Model 9000 Series 800 computers.

While HP is advocating dual stack implementations with OSI Express as a way for manufacturing customers to migrate to full implementations of OSI-based networking, The Wollongong Group's strategy is to help customers preserve their Internet Protocols-based links and stacks and still use MAP applications. In their corporate literature this strategy is explained as follows:

"As standards are developed, the functionality of the existing TCP/IP protocols can be augmented by the OSI protocols without interrupting the operation of the overall system. Wollongong's goal is to offer products that allow for "seamless transition" as customers convert from existing to emerging standard networking protocols."

This policy is in keeping with the fact that over half of the company's products are part of the WINS (Wollongong Integrated Networking Solutions)/TCP group of products and the majority of their networking customers have installed their WINS/TCP networks within the past three years. As a leading vendor in the marketplace for TCP/IP networking, it makes strategic sense for The Wollongong Group to help customers continue to use their Internet Protocol transport layers as long as possible by providing MAP 3.0 user-level services on top of TCP/IP transport layers. In compliance with Wollongong's strategy of preserving existing TCP/IP implementations, the WIN/ULS (Upper Layer Services) product introduced this year

can be used with either a TCP/IP or an OSI transit stack.

From a manufacturing company's perspective, one of the principal reasons to migrate from Internet Protocols to MAP/OSI is to take advantage of the functions that MAP offers in the applications layer. These protocols are just beginning to be available as products. The first two applications-layer MAP 3.0 products that HP will offer are Manufacturing Message Specification (MMS) in the first quarter of 1989 and File Transfer, Access and Management (FTAM) scheduled to ship in the second half of this year. The Wollongong Group also has released an FTAM product called WIN/FTAM for UNIX SV/BSD.

Manufacturing Message Specification is a standards-based command language that includes over 80 calls for program-to-program communications. It provides a standardized programmable interface so that host machines can speak the same language as other MAP-compatible machines such as programmable logic controllers (PLCs) and robots. MMS can be used for programming tasks that range from simple file transfers to complex device control instructions.

FTAM software from HP or Wollongong is the basis for multivendor communications on the factory floor because it provides a standardized way to manipulate files on remote

Wollongong Group Inc.
1129 San Antonio Rd.
P.O. Box 51860
Palo Alto, CA 94303
CIRCLE 270 ON READER CARD

computers. In the acronym FTAM, "T" (transfer) means to store and retrieve entire files, "A" (access) means to store and retrieve parts of files and "M" (management) means to change characteristics of these files. Having a common format makes it possible to exchange data in a multivendor environment.

Both HP and Wollongong plan greatly expanded product lines for OSI-based networking. By the end of 1989 each company will have a full seven-layer implementation of OSI. HP's will combine the OSI Express card and host-resident software for MAP 3.0 applications. Wollongong's implementation will consist of the modular products Upper Layer Services and Lower Layer Services. Companies with TCP/IP networking can use WIN/ULS for MAP 3.0 applications without devoting the time and resources necessary to incorporate the entire protocol suite.

Because HP and Wollongong have two different ap-

Indigo Software
defines
"forms at their
very best" as
"forms with JetForm"

Forms at their very best means a lot of things: forms that are effective, efficient, complete, flexible, organized and never out of date. Forms at their very best means *JetForm*.

Design

With *JetForm* you can watch your form take shape as you build it using mouse and keyboard commands. Powerful built-in design features such as WYSIWYG, user-defined grids, multi-level zoom and pan are at your command.

Flexibility

JetForm allows you to design and print a broad variety of forms, from single-page expense claims to complex multi-page insurance policies and packaging labels containing complex barcode information. All this is done on your choice of stand-alone PCs, PC networks and powerful minicomputer systems.

Speed

JetForm provides the specialized design features needed to drastically cut your forms design time. The data merge/print capabilities maximize print throughput by fully utilizing the graphics capabilities of your laser printer.

Power

For less than \$500, *JetForm* delivers advanced graphics and text handling features not found in forms generation systems costing thousands of dollars.

JetForm and You

JetForm lets you create the forms you need—when you need them. You can design them, change them, print them, and, most important, use them. All the while, you can see your productivity increase, your expenses decrease, and your organization become more efficient than ever.



Forms at their very best—
a reality with *JetForm*

Call (800) 267-9976 (613) 594-3026
Indigo Software Ltd.,
400-560 Rochester Street,
Ottawa, Canada K1S 5K2



JetForm solutions are available for:
IBM PC/AT, PS/2 and compatibles
HP 3000, HP 9000
DEC VAX

CIRCLE 119 ON READER CARD

proaches to the transition between TCI/IP and MAP/OSI protocols for networking, manufacturers that use UNIX system machines as hosts will have the choice between running MAP applications on top of existing standard-based networks or starting fresh with an OSI stack that will coexist with other networks and subnets in the factory. Eventually, those who

choose the Wollongong approach will have MAP running on TCP/IP nodes while those who choose the HP way will have ARPA applications operating in an OSI environment.

Would you like to continue to see articles on this topic?
 Circle on reader card
 yes 328 no 327

[THE OSI MODEL: IS IT REALLY SEVEN LAYERS?]

The OSI model diagrams show a seven-layer suite of protocols, but talk to an OSI vendor and you're more likely to see a hand-drawn sketch and hear terms like link and stack and hear the vendor point out further subdivisions within layers. You may hear the layers referred to collectively as transport protocols and upper layers as user-level protocols. The divisions between commercially marketed standards-based networking products don't always fall neatly within the boundaries of the seven layers of the Open Systems Interconnect (OSI) model for distributed information systems published in 1984 by the International Standards Organization (ISO).

Given an understanding of the seven-layer reference model, it's easier to know which protocols are implemented in various MAP products. In the "classic" OSI model, each layer has the following distinct functions:

Layer 1 — the Physical Layer. Physical layer protocols handle rules for connectors and wiring. These standards govern the way a host computer accepts data bits that travel across the wiring.

Layer 2 — the Data Link Layer. Data link layer protocols regulate how data is arranged in packets and then sent to the network layer. IEEE's 802.2 provides standards for link-level services.

Layer 3 — the Network Layer. Level three protocols have to do with how packets from one host are routed to both local and remote hosts and how to assure that the receiving host can process the data coming from the sending host.

Layer 4 — the Transport Layer. There are five different protocols for the transport layer, but only two of them TP4 and TP0, will see widespread use. The TP4 implementation of the Transport Layer assures end-to-end reliability with 802.4 standards. These implementations are used in manufacturing local area networks (LANs) and are found mostly in the U.S.

The TP0 implementation with X.25 standards provides a simpler but less reliable Transport Layer. The X.25 approach is used in European implementations, especially in wide-area, multinational networks. Although both TP0 and TP4 conform to OSI standards, the incompatibilities in the transport layers mean that TP0 and TP4 networks can't talk to one another unless there is a transport bridge.

Layer 5 — the Session Layer establishes, coordinates and closes connections between sessions. These activities are referred to as interprocess communication (IPC) activities. Sessions must be established in order for applications to share data via file transfers or use virtual terminal services.

Layer 6 — the Presentation Layer resolves the differences between how data is represented in two different systems by converting the message into a standard format so that both the sending and receiving hosts can interpret the message. ASCII format for text files is an example of a presentation layer standard.

Level 7 — the Applications Layer. This layer provides services to the user. Level 7 standards concern file transfer, remote terminal access, electronic mail and other applications involving distributed processing. The Application Control Service Element (ASCE), which resides on this layer is a set of protocols for establishing and breaking off connections with applications on the network.

As for the simpler divisions to describe implementations of the OSI model, Brice Clark of Hewlett-Packard's Roseville Networks Division depicts the OSI model in an hourglass diagram that shows choices for links (the physical level) because HP's MAP customers can choose either broadband or carrierband for the wiring, the stack (roughly layer two through six), and services (layer seven) that customers can choose according to application requirements.

The Wollongong Group divides the model into Lower Level Services (levels one through four) and Upper Level Services (levels five through seven). Marshall T. Rose, principal software engineer for The Wollongong Group, points out that there are some transport relaying (layer 3) services that a Wollongong product called Transport Service Bridge actually performs at the network level (layer 4). Wollongong plans to release products for Upper Level Services in the first part of 1989 and Lower Level Services in the second part. —Peggy King

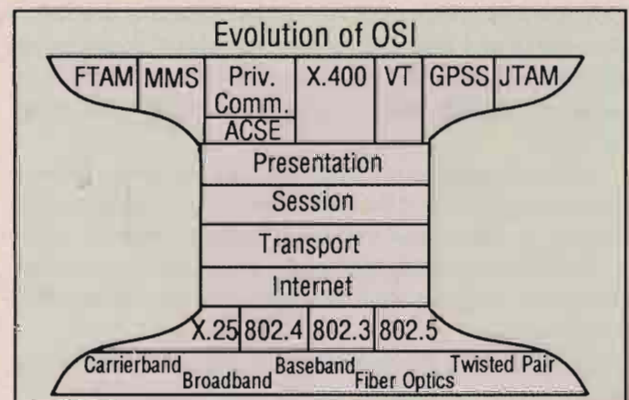

Distributed Databases

▲
The State Of The Art
▼

If you're the manager of a medium-to-large data processing facility with more than one office location, then you face the problem of designing computer facilities at minimal cost in order to meet different user application needs.

In the stone age of computing, the answer was simple: You bought a large IBM mainframe for the head office and placed dumb terminals in all appropriate locations that linked back to the central system. Everyone was happy, except maybe your vice president of finance, but you always thought of some technical reasons he didn't understand for not doing it any other way.

From a management standpoint, this was great. All your data-processing staff and facilities were in one location, so they were easy to control and you could build a center of expertise. All the applications could easily interact because they are on the same computer, and your salesman was always there to back you up.

Unfortunately, the economies of scale no longer apply. Multiple small computers can give you more effective throughput at less cost than

a single large system. For example, how many Micro 3000s can you buy for the cost of a Model 70? With a single large system, you're placing all your eggs in one basket, and you're vulnerable to computer failure or "acts of god."

In addition, there are communication costs. The prices of computers are dropping much more rapidly than the cost of telecommunication links. If you look at almost all real situations where locations are spread geographically, the communication costs are a very high portion of the project budget (particularly if you capitalize the on-going costs). For these reasons, no telephone network supplier has ever proposed a centralized telephone-switching system.

However, it is very easy to go to the other extreme. At a board meeting I once attended, someone proposed, "Why don't we ditch our expensive centralized minicomputer and buy 50 PCs to spread around?" I don't think I need to explain the problems this would've created a few years ago in trying to share data between applications/programs. The cost of this solution in terms of the chaos, additional clerical procedures and management time was very high.

So, there has to be some optimal mid-

[BY ROGER LAWSON]

Partitioning between processing in a network usually is based on a mixture of locational division and functional division.

point between total centralization and total decentralization that minimizes the costs, yet supports the application needs (see Figure 1). There always are many possible solutions and the options are increasing all the time, so it's usually necessary to cost out a few alternatives to see which is most economic.

Let's assume we've settled on a distributed system of some kind, and look at some of its characteristics:

- It compromises more than one computer (or processing unit).
- The computers are interconnected (even if only occasionally).
- Significant interaction takes place between computers.
- A single-system image in the user interface is preferable.
- Many design alternatives are available.

Note that the logical mapping of application system needs onto physical systems is constrained by technological capability and cost. The latter are changing rapidly. However, the mapping is likely to be approached by looking at the clusters of processing (both machine and human) and the dependency between processes.

The resulting analysis may come up with the same labels as we use conventionally; e.g., inventory control is an application characterized by the processing of stock records. The degree of interaction, volumes of data flows, required fault tolerance, organizational impact and other such factors can affect how these clusters are perceived.

Partitioning between processing in a network usually is based on a mixture of locational division and functional division. Geography has a large impact on the communication cost, so applications often are grouped together and run at one site (this is the "branch computer" scenario where all functions for a location are run on one computer at the location with the same system being replicated at each branch). Alternatively, the network may be split functionally in accordance with managerial structure; e.g., the finance department has its own computer and associated network; production has a different network with possibly different computer equipment, etc.

Single-System Image

IT CERTAINLY WOULD BE ideal to provide data and service location transparency. The user could call upon services or data anywhere in the network using the same commands and without knowing where the data or processing was located. This can be made easier if you have *homogeneous transparency*: All nodes in the network run the same computers with the same operating system and database management system.

However, in reality, most users have a mix of equipment, so it also would be nice to have *heterogeneous transparency* where different nodes run different DBMSs. Obviously, this is much

FIGURE 1

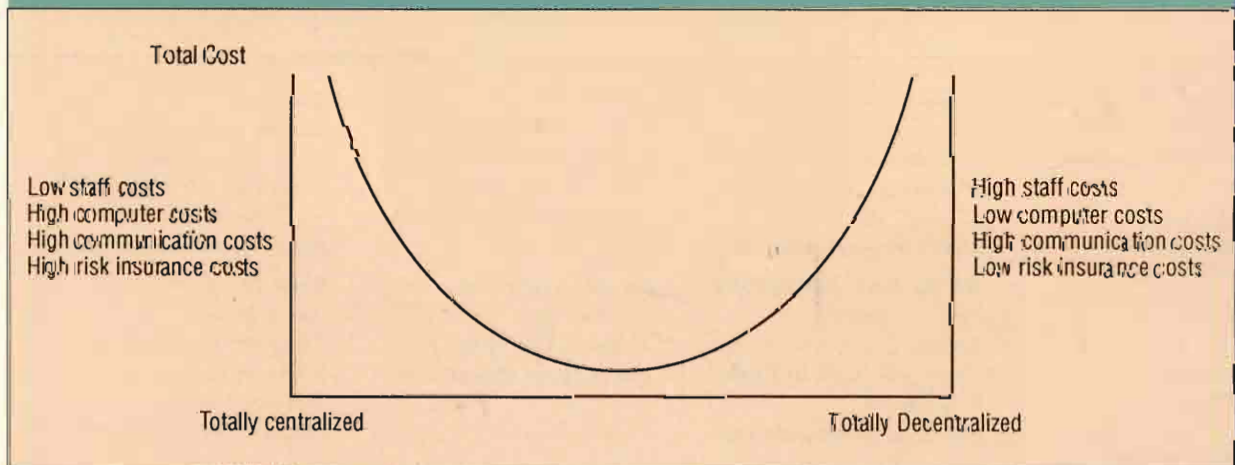

There has to be some optimal midpoint between total centralization and total decentralization.

more difficult to achieve, but progress is being made towards this possibility with the OSI standard, the increasing similarity of relational databases, the possible standardization on SQL as the database access language, etc.

Replication

IN AN IDEAL WORLD, you wouldn't have replication of data in a network (i.e. multiple copies of the same data). One of the early selling points of IMAGE and other DBMSs was the ability to avoid data redundancy. However, if you look at any operational database, it usually still has it, not necessarily because of poor design, but because you need to optimize data retrieval.

In networks, you need it for the same reason. For example, to retrieve a record from a local computer is going to be much faster than from a remote system. If the ratio of inquiry to update is high, then it can be more cost effective to hold multiple copies (the communication traffic can be minimized and hence the cost). You also may find it more economic to balance the workload over multiple locations by having replication. In addition, you need multiple copies for back-up and redundancy. Unfortunately, data networks, particularly international ones, are not very reliable and even the best computers (e.g. HP 3000) are going to be down occasionally.

Failure Probabilities

RULE OF THUMB: Don't design a large network on the principal that all of it will be there. Because failure probabilities are multiplicative, even a 99 percent up-time for any one node means a high probability of partial system failure on the network as a whole if you have more than a few nodes or links.

Replication, therefore, is useful, but synchronization and recovery (e.g., rollback) on failure must be considered.

Moreover, if you have replication, you need data location transparency plus preferably query optimization. There

Unfortunately, data networks, particularly internal ones, are not very reliable and even the best computers are going to be down occasionally.

is not much point in having a local copy of the data if your end-user report writer chooses by default to take data from the remote system.

Let's see how HP products such as IMAGE and NS and other vendors' products match up to the above requirements.

IMAGE was designed on the principle that a database was a single logical unit. There still isn't a multiple database recovery option on the same computer, let alone on a distributed system. The ability to access and update a database on another node in the network is provided, but you need to know where it is (you can provide limited location transparency by simply using log-on file equates).

TurboIMAGE, IMAGE, Net Delivery, HPSQL, HP-UX, HP 3000, System Dictionary, DS/3000

Hewlett-Packard
3000 Hanover St.
Palo Alto, CA 94304
CIRCLE 290 ON READER CARD

Mirage

Datasoft International
129 Mt. Auburn St.
Cambridge, MA 02138
CIRCLE 285 ON READER CARD

Speednet

Infocentre Ltd.
7420 Airport Rd. Suite 201
Mississauga, Ontario
CD L4T 4E5
CIRCLE 286 ON READER CARD

BACKCHAT, BACKBONE

Proactive Systems
Central Court, Knoll Rise
Orpington, Kent BR6 OJA
England
CIRCLE 289 ON READER CARD

Ingres

Relational Technology
1080 Marina Village Pkwy.
Alameda, CA 94501
CIRCLE 284 ON READER CARD

Oracle

Oracle Corporation
20 Davis Dr.
Belmont, CA 94002
CIRCLE 283 ON READER CARD

Encompass

Tandem Computer Inc.
19191 Vallco Pkwy.
Cupertino, CA 95014-2525
Mail Stop 4-43
CIRCLE 282 ON READER CARD

Model 70

Epson America
Computer Products Division
2780 Lomita Blvd.
Torrance, CA 90505
CIRCLE 281 ON READER CARD

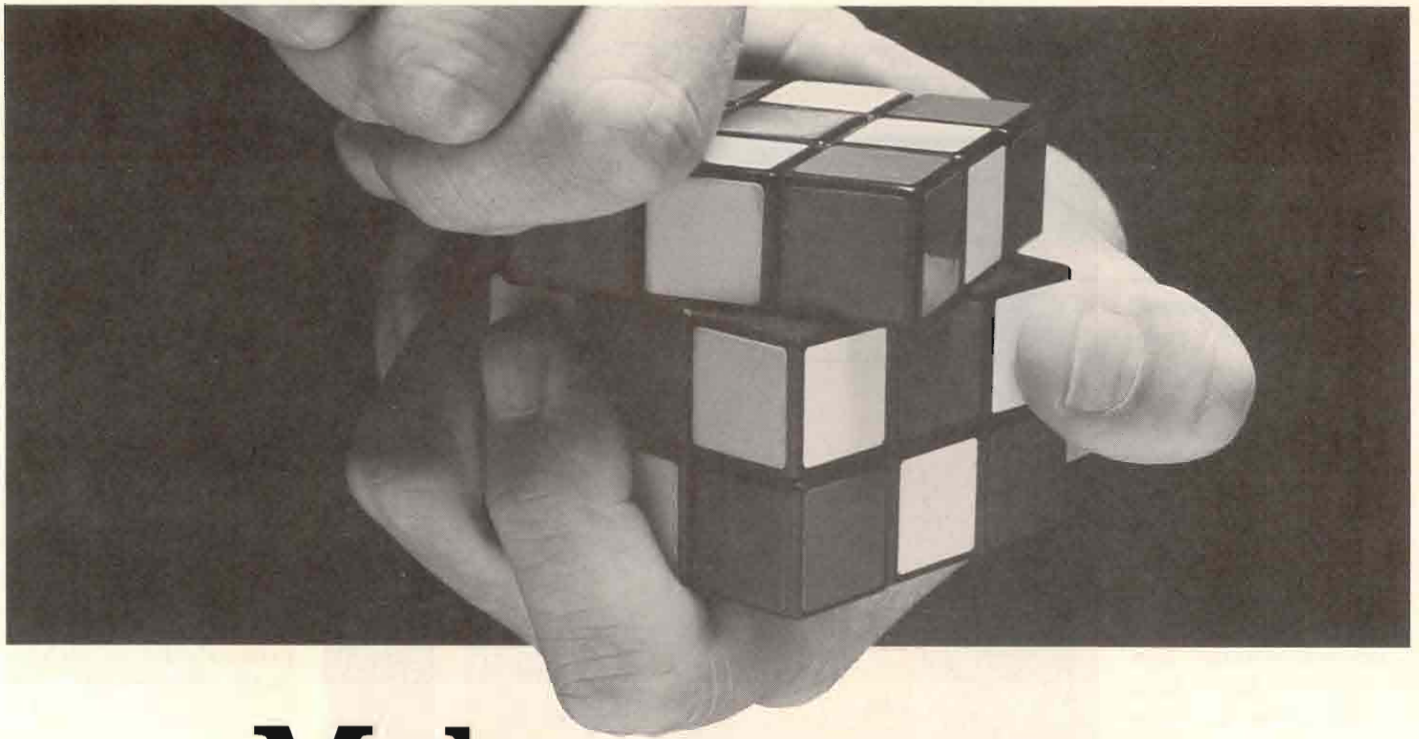

Make sure your data is in safe hands.

If your company depends on more than one HP3000, you need BACKCHAT. It can spread the workload and provide fault tolerant systems, giving simple solutions to everyday problems.

BACKCHAT logically links multiple IMAGE data bases and other files in an HP3000 network, simplifying the design of distributed processing systems and minimizing the impact of network failures on your operations.

BACKCHAT enables you to replicate data from one computer to another in real time. If one computer fails, users can switch to the backup copy in seconds.

PROACTIVE SYSTEMS
PO BOX 7102 BLOOMFIELD HILLS,
MICHIGAN 48302 USA. TEL: 313-333-7200

5053 LA MART DRIVE, SUITE 101, RIVERSIDE
CALIFORNIA 92507 USA. TEL: 714-683-7921

CENTRAL COURT, KNOLL RISE, ORPINGTON
KENT BR6 0JA ENGLAND
TEL: 0689-77933 TELEX 9413362

FRANCE: 1-49-01-05-00
WEST GERMANY: 0931-275285

It spreads the application load over more than one HP3000 and optimizes performance. For example, you can offload inquiry/reporting activity to a second computer.

BACKCHAT also allows users on separate computers to read and update the same data irrespective of its source. Therefore you can build systems without being limited by computer performance or the location of data.

Get a helping hand from BACKCHAT to build fault-tolerant or distributed systems.

Call Proactive Systems now.

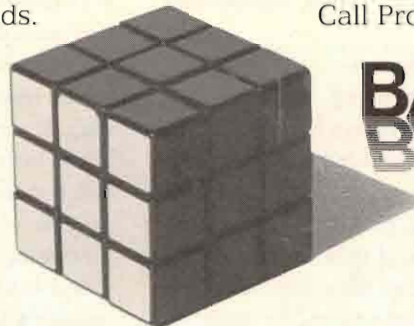

BACKCHAT

BACKCHAT

BACKCHAT is a trade mark
of Proactive Systems Ltd

IMAGE is a trade mark of
Hewlett Packard Company

If the remote database or link is out of action, then your local application aborts. In addition, if you have more than a few remote "sessions," your computer processor load is excessive.

You have very limited replication of a whole database with SILHOUETTE (or more extensive options with BACKCHAT from Proactive Systems such as specific data sets or even selected records). You certainly don't have heterogeneous transparency (you can't link a TurboIMAGE database on HP to an IBM or DEC database, for example).

However, things are progressing. There is HP Net Delivery, which at least gives you callable intrinsics to help you pass data around a

network in "batch" mode, even if you need to do a lot of ad hoc programming. There is Speednet from Infocentre, which attempts to map an IMAGE database (with local replication) onto PCs plus Datasoft's MIRAGE.

There is HP SQL which is a more industry-standard form of database, even if it may not be ideal in the short term for high-volume, transaction processing commercial systems.

The two major relational database suppliers are Relational Technology (with Ingres) and Oracle Corporation (with Oracle). Both run on a variety of DEC, IBM and HP-UX hardware — Oracle also is being ported to the HP 3000.

Ingres Star has the following implementation schedule for distributed DBMS functions:

- Phase 1 (available now) — Location transparency, multisite read (single-site update).
- Phase 2 — Multisite update, data replication.
- Phase 3 — Gateways to non-SQL systems (e.g., IMS)

Oracle is developing SQL*STAR, Tandem has Encompass and HP is doing some R&D on relational distributed databases.

As you can see, the main thrust in distributed database development is on relational databases, primarily because they are simpler and more industry standard than most network databases (e.g., limited data types) and they don't have the problems of embedded pointers (simple tables are easier to

replicate).

To cope with the problems of data location transparency, query optimization, etc., most academics in this field propose a global data dictionary that holds information on the location and content of each database (plus its type if you're aiming for heterogeneity). This has to be replicated on each node (or a subdictionary maintained of those parts relevant to each node). HP System Dictionary might form a basis for this type of overlay. Obviously, this proposal lends itself to the use of a hierarchic network and is less easy to implement on an anarchic one.

To handle the problem of transaction atomicity (i.e., how to

ensure consistency and recovery on failure when a transaction can initiate multiple updates on multiple nodes), there are three possible methods:

- *Two-stage commit.* Effectively, the local system asks for a lock on each remote system. If it is given, the transaction is applied and then each commit checked. If any node hasn't processed the transaction, it is rolled out on all the others, automatic deadlock avoidance also is required in this case). This currently is the favored technique, but bearing in mind the amount of communication that takes place for a single update, I wonder if any commercial system with other than very low data volumes could function using this method. Also, it assumes that all the network is operational, which is a big "if."
- *Time-stamping with inconsistency checking.* Records are given a time stamp so they can be serialized when applied to a remote database (if a later transaction is discovered as being applied to the remote database before the local one, then it's rolled out). A variant of this is used in BACKCHAT, where it's possible to turn on a check that the remote record being updated still is consistent with how it appeared to the local updating process — if it's the update applied — otherwise, exception-processing routines are entered. This method copes with time delays between local and remote systems (because of communication time or temporary node/comms failures).

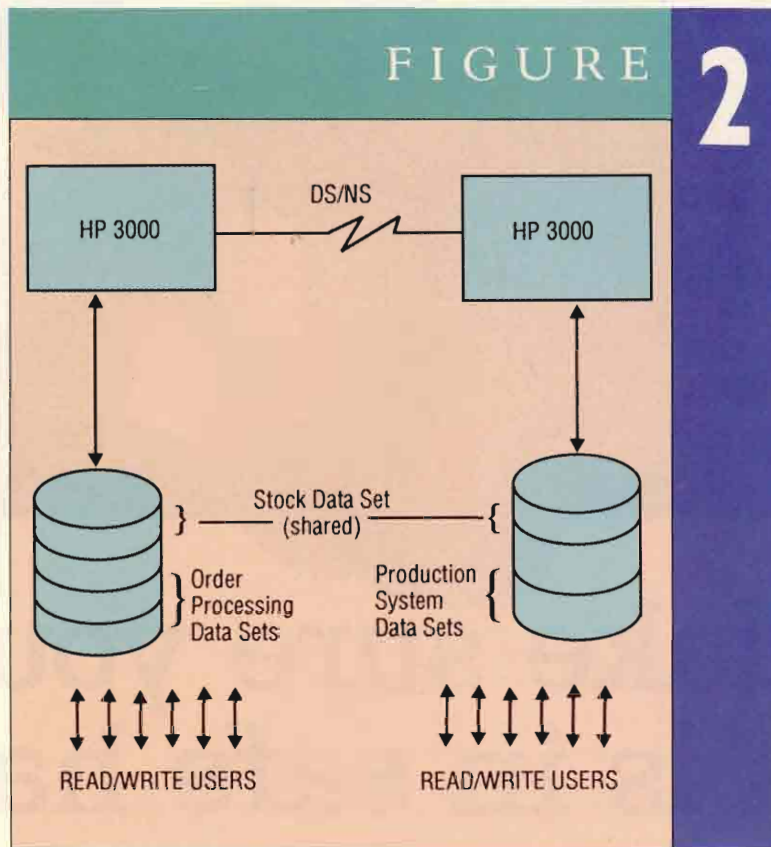

A part of the database is replicated over both systems.

There's one error even our software won't flag.



When it comes to computer operations, you'll find NSD's JobRescue™ is perfectly matched to your needs.

The reason? It's integrated. Which means you can have one program that answers all your production requirements. That's because JobRescue now has expanded capabilities. So we handle everything from reports to production scheduling to batch job management.

But make no mistake! We are still the standard in error management for HP. During operation, JobRescue works online and in the background. Examining your \$STDLISTs for errors continuously. And alerting you when they occur.

Still, eliminating hidden production errors is just the beginning. Our new report and scheduling modules will help you greatly improve the overall quality of your work as well. So you can now manage virtually every facet of your computer operations.

That's why you should give us a call. We'll answer any questions you have and send you our JobRescue demo.

JobRescue. You need it for a very basic reason. Nobody's perfect.



NSD, Inc. 1670 South Amphlett Blvd.
Suite 103, San Mateo, California 94402
800.538.3818, (In CA) 800.538.9058
Canada 800.445.3818, Local 415.573.5923

CIRCLE 129 ON READER CARD

JobRescue is a trademark of NSD, Inc.

Looking for Trouble HP 3000 Software

■ A pragmatic approach where the database software imposes no limitations, but the application design has to be done to avoid conflicts. This is not as difficult as it seems in practice (this is what has to be done in most clerical systems, for example).

We at Proactive Systems had the problem a couple of years ago of meeting most of the above requirements for a particular application to be based on IMAGE databases running on multiple HP 3000s. We used the IMAGE logging mechanism to collect information on local updates and, by passing them around a network to perform the remote processing.

IMAGE log records contain a nice logical transaction definition in a serialized form over multiple databases (we even can do multidatabase recovery from it). They contain both "before" and "after"

representations (but otherwise minimal data, which minimizes the comms load), so consistency-checking is possible when a global lock would be impractical. They can be collected with minimal performance impact on the local system and "pipelined" to any remote system. Therefore, it is very practical and easy to build the type of application shown in Figure 2 (which is a very simple picture of the kind of thing that can be done).

In Figure 2, a part of the database is replicated over both systems. Users on both computers can update the same data. Recovery is automatic whenever or wherever a failure occurs.

On each node in the network, which is configured independently and therefore can be totally anarchic, is a configuration file that contains information on the "shared" (or "replicated") databases/sets, the incoming/outgoing communication paths and processes, etc. Each node uses IMAGE in the normal way — no special programming is required and the system can be implemented with no application changes.

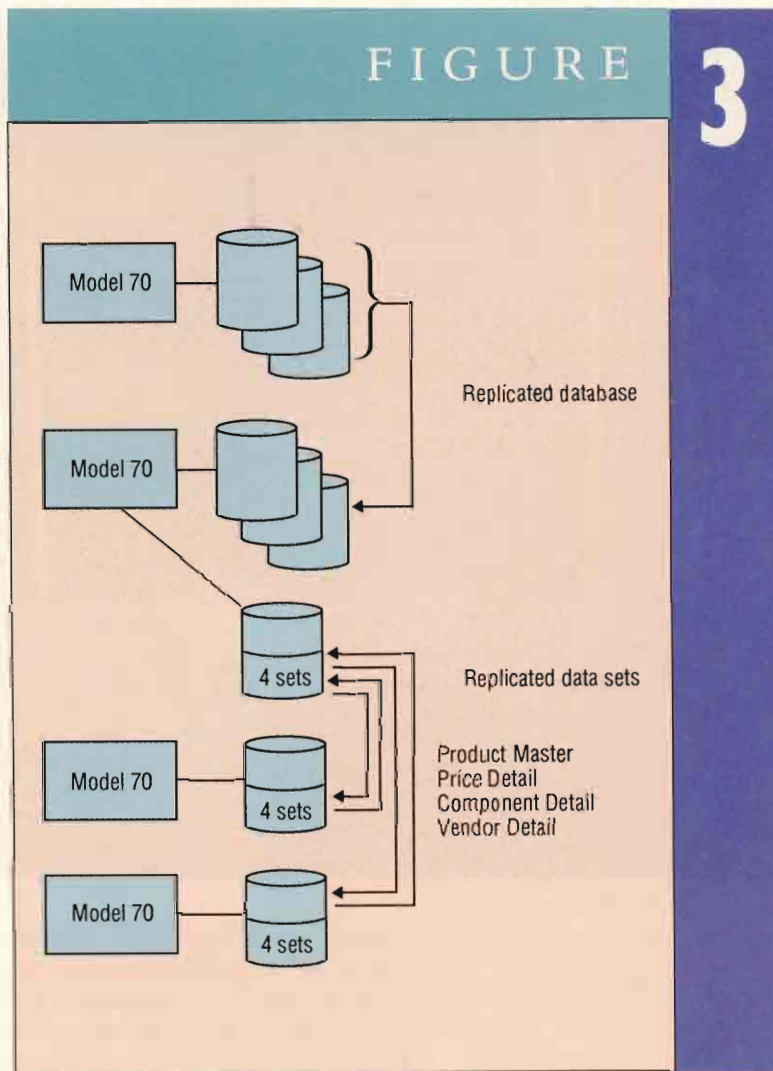

The hardware configuration

FIGURE 3

We also recently have supported database location transparency for IMAGE users with a module called BACKBONE. This contains a global dictionary in which database location is specified and the use of NetIPC to "pipeline" user access to databases to the correct computer.

Epson America used this approach to spread its workload and provide fault tolerance over multiple locally-connected Model 70s.

In this case, for managerial reasons, it was chosen to centralize the computer installation and support services. However, to provide redundancy and because of the limitation on the power of any one HP 3000 computer, it was decided to spread the workload over several Model 70s. This involved both replication of a complete database and selected replication of certain "reference" data sets

(i.e., those that contain semistatic data referenced by many systems). However, the latter can be updated on more than one of the computers so the system provides transparency of data location. The hardware configuration is shown in Figure 3.

It is possible to build distributed systems based around IMAGE pending the arrival of other solutions based on SQL. It certainly is practical to build high-performance, distributed, transaction-processing systems that embody data location transparency without writing a lot of application-specific code. —Roger Lawson is managing director of Proactive Systems, based in California, Michigan, London, France and Germany.

Acknowledgement: This article is based on a paper first presented at the SCRUG '88 User Group meeting in Pasadena, CA.

Would you like to continue to see articles on this topic?
 Circle on reader card
 yes 338 no 337

IN ORDER MANAGEMENT SOFTWARE:

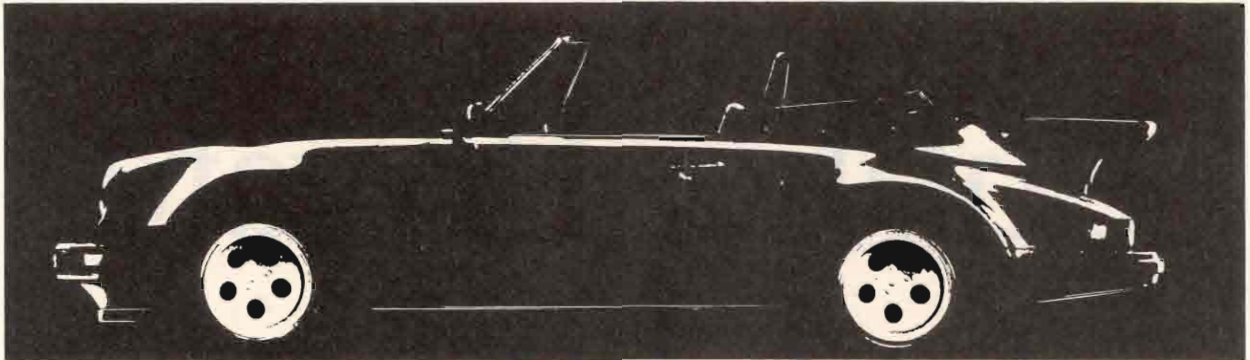

THERE'S CUSTOM.

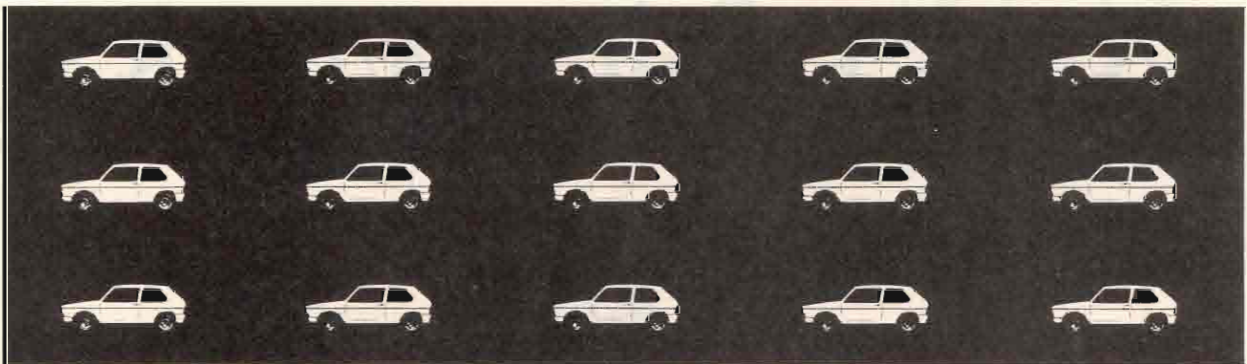

THERE'S CANNED.

If you think it costs a fortune to have software tailored to your company's exact sales and purchase order requirements, think again. Cardinal's unique approach to order management gives you the fit and functionality of a custom solution for about the price of a canned package. The secret: the Cardinal Configurator, an exclusive architecture that lets you specify, in detail, an unlimited

number of order types and how each is processed. If your needs change, your systems can change with them—with no reprogramming.

Why settle for a canned solution? Or spend a fortune on custom? Call Cardinal. And get the best of both worlds.

AND THERE'S *CARDINAL*.

 cardinal data corp

75 Second Avenue, Needham, MA 02194 • (617) 449-0066
Boston • Los Angeles • Toronto • London • Sydney



INTEGRATED SOFTWARE FOR: ORDER MANAGEMENT • PURCHASING • INVENTORY • RECEIVABLES • PAYABLES • GENERAL LEDGER

CIRCLE 108 ON READER CARD

Selecting The Right Network Is Your Most Important Decision

Public, Private And Hybrid X.25 Networks

[By Gordon McLachlan]

When selecting an X.25 packet-switched network (PSN), choosing either a public data network or a private network will be the

single most important decision you will make.

The type of network you select will determine your networking options for a long time. Such factors as cost, network capabilities, network management and security features all must be considered carefully before making that decision.

The major difference between public and private PSNs is reflected in their names. In a private network, you manage the network yourself. You own or provide all of the packet-switching hardware, packet assembler/disassemblers (PADs) and data lines. This is the type of network provided by HP in its Private Packet Network. If you use a public network, you subscribe to network services on shared facilities that are owned and operated by network companies such as McDonnell Douglas-Tymnet and the GTE/United Telecom Telenet/Uninet networks.

Overall cost is completely dependent on traffic volumes in the network. Public network charges are based on the number of users, connect time and the volume of data transmitted.

Private PSNs have a higher entry cost because of the data lines, X.25 equipment and software required at startup, but the network's costs will remain relatively fixed, regardless of the traffic.

If you have a small number of users spread out over a wide geographic area, a public network will be very attractive. Because the public data network provides

nationwide and even international access, those remote, low-volume sites can be serviced much more inexpensively than if all of the data lines and PSN equipment were required.

Operationally, the differences between public and private PSNs are evident in their performance capabilities and their network management facilities.

A public network always will provide slower response time than a comparable private network, perhaps only two thirds or less of the nominal data rate. Besides being a shared facility with much higher traffic volumes, a public network will force a connection to traverse more switching nodes than would a tailored private PSN.

Slower effective speeds on the public networks are exacerbated by the need to dial into the network at 1200 or 2400 bps. Higher-speed dial (4800 bps) and dedicated X.25 access (up to 19.2 kbps) are available in major metropolitan areas, but are expensive. If volume or response time requirements are sufficient to justify dedicated access, they may justify private facilities.

PUBLIC NETWORKS ARE considerably more flexible. New sites and services can be brought up on short notice without major expenses for hardware and software. A well-designed private network also will be flexible if its capacities and routes are well planned, but may cost more and require longer lead times for installation of hardware and data lines.

However, there is one important public network capability that simply is not available to private network operators. Internetworking, or communication between different X.25 networks, is implemented according to the CCITT X.75 standard. X.25 only specifies the interfaces between terminal or

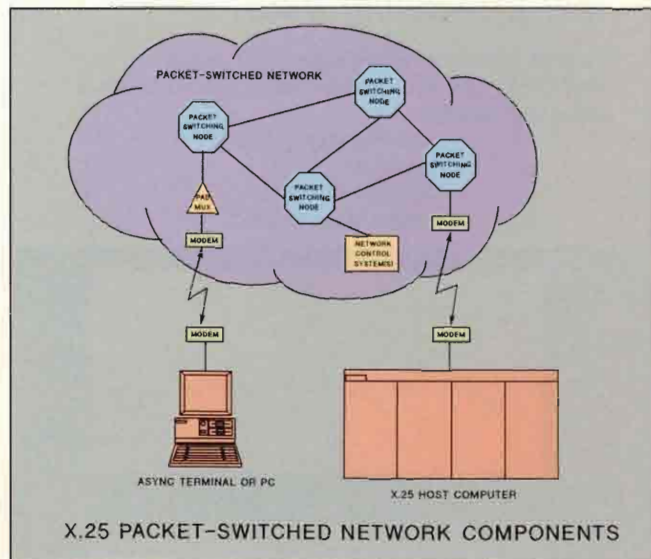

The PAD (packet assembler/disassembler) takes character input from asynchronous terminals and groups them into X.25 message packets. PADs may function as multiplexers or provide protocol conversion and terminal emulation capabilities. The Packet-Switching Nodes route message traffic through the network. The X.25 standards define the interfaces between the network and the computer equipment, but not the connections between the switches. Network Control Systems handle network configuration, diagnostics, security and call accounting.

computer equipment and the X.25 packet-switching nodes, not communication between the switches themselves, which may use proprietary protocols. Unfortunately, internetwork ad-

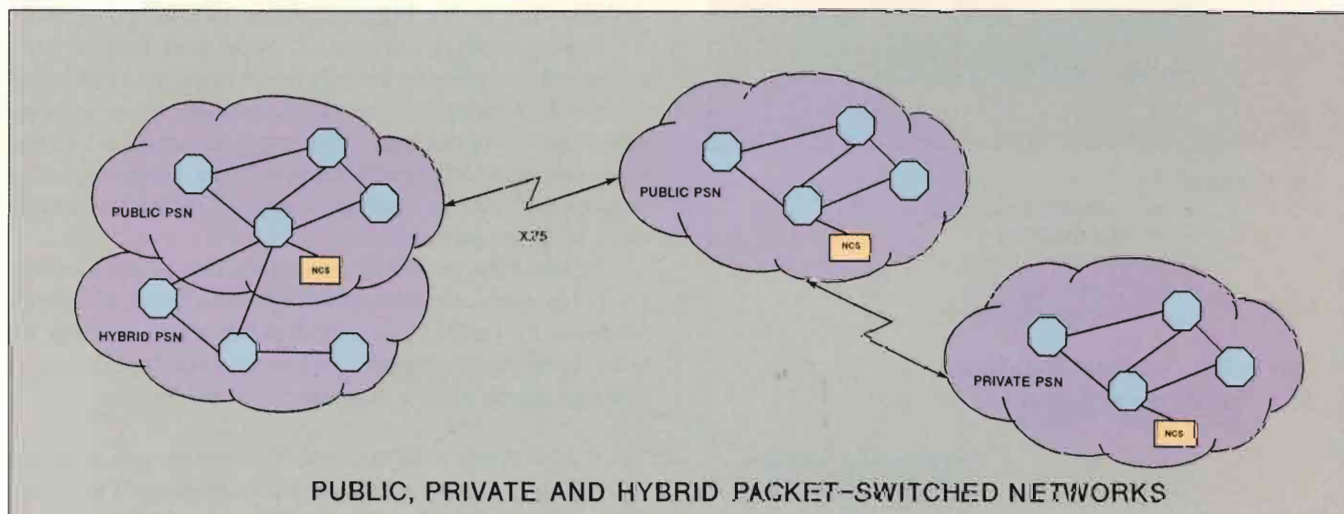

The primary difference here is the location and control of the Network Control System (NCS). In a hybrid network, the NCS will be part of, and under the control of, the public PSN provider. This makes the hybrid network a subnetwork of the public PSN. A private network has its own NCS. A private network may not use the X.75 standard to connect to other X.25 networks.

Powerful solutions for analyzing and presenting data.

Systems supported on HP Series 1000 and HP Series 9000/UNIX. Over 1000 installations in use worldwide in varied applications.

- Statistical quality control
- Research
- Technical illustration
- Process trend graphics

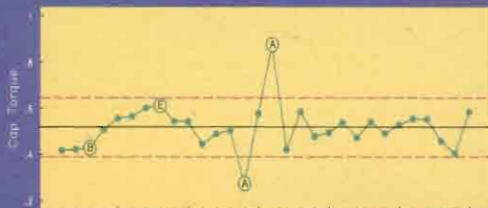

UCL = .3915 CL = .5198 LCL = .4482
 Subgroups : 30 Control : 3.00 σ Rules : WE
 Subgroup size : 5

Control Chart Summary :

- A) 1 point outside the control limits.
- B) 2 of 3 points outside of 2 sigma.
- E) 8 successive points in one direction.

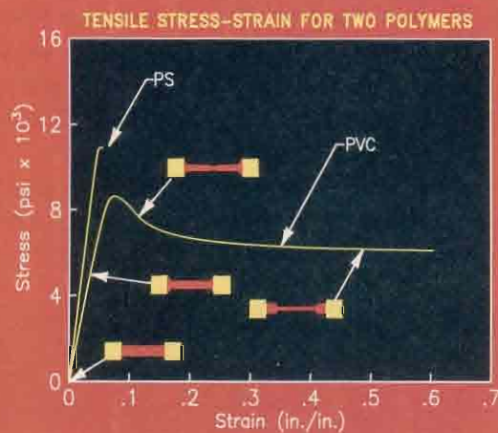

With features like:

- Programmatic access
- Full integration
- Publication quality
- Powerful statistics
- Database integration

Call us today for powerful solutions.

206-828-4691

graphicus

150 Lake Street, Suite 206
 Kirkland, WA 98033
 TWX: 9102407809
 FAX: 206-828-4236

dressings standards restrict the use of X.75 links to the public networks. If you have internetworking requirements, talk to your network hardware and software suppliers to see how they can handle it.

Network Management

NETWORK MANAGEMENT IS AN AREA where there are marked differences between public and private networks and between different vendors of each network system. Public networks are managed by the supplier. If you don't want to maintain a network control center to operate your PSN, a public network may be a good bet. Management of a private network is your responsibility, but as an alternative, some private network suppliers, like HP, also offer customer network management services that can run your network for you.

Network management tools for call accounting and billing, security administration, diagnostics and measuring network utilization and performance are critical for effective network control and planning. The type and quality of these tools will be the most obvious differences between networks. Out of necessity, the tools supplied with a private network are much more comprehensive than those from a public PSN. Public networks will supply you with the most basic information because they are running the network.

Private PSNs are potentially more secure than public networks because you can maintain better control of physical network access points. If your company is extremely security conscious, the sheer number of dial-in ports that are provided in a public network and the fact that your data will be traveling over shared, and therefore non-secured communications facilities, may be too big an exposure to a security breach.

Public network security is good, and they actively monitor the network for security breaches, perhaps better than you can, but restricting physical access is still one of the most effective security methods. Data encryption may be added to the network, whether public or private, but check with your vendors to determine compatibility with the network hardware, software and protocols.

Private PSNs are usually easier for a user to navigate than the public networks because of the extra layers of security needed in the public PSNs and the multiple sign-ons they require. Some public network vendors offer customizable menu software which greatly diminishes this problem.

IF YOU HAVE A MIXED bag of network requirements, perhaps neither a public nor a private network would be an ideal choice. The technical expertise available in your company to manage a network, or the need to access other public networks, might suggest a public network, while security, network management or cost considerations might

HOW TO DO BACKUP IN A MOST EFFICIENT WAY?

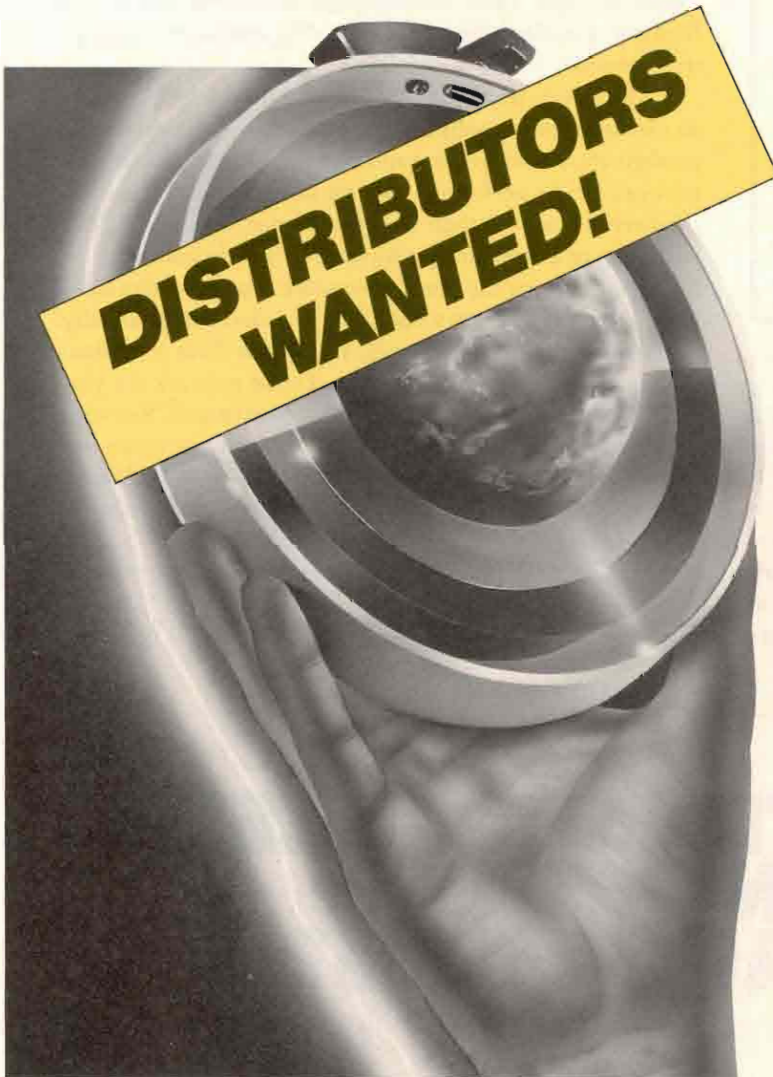

**As a first step
please answer
the following:**

	Product A	Product B	HIBACK/3000 by HI-COMP
All Current and Future HP Storage Devices Supported			yes
Cost-Effective Backup Solution			yes
Efficient all Character Compression			yes
Unattended Operation			yes
Reasonable Software Support Fee			yes
Regular Distribution of Enhancements			yes
Private Volume Support			yes
LAN/DS Network Support			yes
Considerable Customerbase			yes
Substantial Time and Tape Savings			yes
Append to End of previous Backup Set			yes
Multiple Tape and Disc to Disc Backup			yes
User Selectable Compression			yes
Automated Functions			yes
Restore on any HP 3000 System			yes
Wild Card, File and Date Selection			yes
User Access during Backup			yes
Full Operation with MPE-V/MPE-XL			yes
Easy to Install, Easy to Use			yes
HP Response Center Support (*)			yes

* currently Wes! Germany only

Simply, give yourself the answer. If you have to state only one NO, you better should talk to HI-COMP.

Even if you don't have several hundred systems, like some HIBACK/3000 users, you can take advantages of HIBACK/3000's features.

HIBACK/3000 has the fullest feature set and it is reasonable priced.

HIBACK/3000 will increase your system's productivity. It saves your organization money every day you use it.

HIBACK/3000 means performance and it is smarter.

Call today and let HIBACK/3000 start saving your organization time and money!!!

See us at IUG '89/ BRUSSELS Booth #1009

HI-COMP Hinrichs GmbH
Eichenlohweg 24
2000 Hamburg 60
West Germany
Telephone: +49 (40) 630 4011
Telefax: +49 (40) 6316004

H · I · C · M · P
INTERNATIONAL
Professional Software Tools for Hewlett-Packard Computers

HI-COMP America, Inc.
305 Broadway, 4th Floor
New York, N. Y. 10007
Telephone: (212) 732-1946
Telefax: (212) 233-4678
Toll free: 1-800 DBETUNE

For all other countries contact HI-COMP for the supplier nearest you.

Depending on your needs, any of the three X.25 alternatives can provide an excellent backbone network . . .

indicate a private PSN. In this case, a hybrid solution, which combines features of both public and private networks, may be the best approach for you to take.

To construct a hybrid network, a private subnetwork is connected via one or more leased data lines into a public network. This connection will allow access to the public network from the private PSN and vice versa. You will have to buy your private network equipment from your public network ven-

dor if you want a true hybrid solution that will accommodate access to other PSNs through the public network's X.75 facilities or to share the use of the public PSN's network control systems.

The private portion of the hybrid network is operated as an extension of the public network. Security administration, configuration management and capacity planning in a hybrid network can be performed only by the public network's administrators or with their direct assistance. This could be an advantage or a disadvantage, depending on your point of view, but by eliminating the need for network control system hardware and software, entry costs can be reduced substantially.

Depending on your needs, any of the three X.25 alternatives can provide an excellent backbone network for your company's growing communications requirements. Knowing your future requirements and knowing the major issues will make the choice between them easier. —Gordon McLachlan has 12 years of experience as a senior systems representative, consultant, technical planner and operations manager.

Would you like to continue to see articles on this topic?
Circle on reader card
yes 326 no 325

ARE PRODUCTION PROBLEMS COSTING YOU AN ARM AND A LEG?



When Something Goes Wrong With Your Process You Need To Know About It. Fast.

The Process Monitoring and Information System (PMIS) does just that. PMIS monitors almost any device in your manufacturing facility and provides you with this information through interactive graphical or alphanumeric displays WHICH YOU CAN DESIGN. PMIS can also generate statistical charts, graphs and plots based on both current and historical process information.

What other features can PMIS provide?

- Manual or automatic control of your processes
- Completely open system architecture
- Data logging to files, databases, or remote computer systems
- A flexible environment through menu- or file-driven configuration
- Control and monitor batch, continuous, and discrete processes

*PMIS is fully supported on HP 1000 A-series and HP 9000 Series 800 computer systems.

Want to know more about how PMIS can save you dough? Call Bradley Ward, Inc. at (404) 396-4292.



BRADLEY WARD, INC.

CIRCLE 105 ON READER CARD

ARIS/BB
(Automated Reader Information Service)

Announcing

HP Professional's On-line Bulletin Board

Dial in to HP Professional's on-line bulletin board and . . .

- Find out more about the products you need
- Get help with your computing problems
- Send messages to the editors
- Submit a change of address
- Order books and back issues
- Check the guidelines for submitting articles
- See the editorial calendar for the year
- "Talk" to other users
- Download programs from HP Professional

. . . And more!

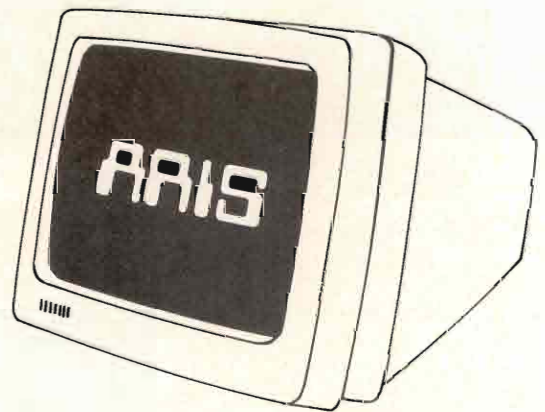

GET ON-LINE - IT'S FREE!

The bulletin board is a direct line to editors and your colleagues in the HP market. To get on-line you need a PC or a terminal with a modem and your mailing label from HP Professional magazine. There's no charge to log on.

Be An Active User

The ideas and experiences you share are valuable to other subscribers. Each month the most interesting bulletin board exchanges will be published in a regular column in HP Professional.

Here's How . . .

1. Set your PC to seven data bits, one stop bit and space parity, or eight data bits, one stop bit and no parity (300, 1200, 2400 baud available).
2. You may dial in through any one of the following centers:
 - East Coast - Dial (215) 542-9458.
 - Southwest - Dial (818) 577-9100.
 - Northwest - Dial (415) 873-2135.
3. You'll be asked for your name and subscriber number (the number is on your HP Professional mailing label).

Dial in today!

Any questions or problems getting on-line, call Anne Schrauger at (215) 542-7008.

HP Professional

Reflection... Now you see it, now you don't. No



Not quite magic, but almost as good. Reflection's unique multitasking feature turns your PC into a double-duty workstation. Only Reflection lets you **hot-key** between your terminal session and a DOS application.

Not bad! But what makes this feature like magic is the way Reflection continues to execute

commands, perform file transfers, and monitor the host session, even while it's in background. Improve your productivity by getting two things done at once.

Reflection does more and uses less memory than the competition. And Reflection lets you connect to your host through tried-and-true RS-232 or a variety of PC networks,

including Novell and even Digital's LAT.

Reflection has set the standard against which all others are measured. Over 250,000 users worldwide enjoy the advanced features and superior support they get when they choose Reflection.

Save money and save memory. Trade-up to Reflection and

Now you see it, now you don't. Now you



Hot-Key to Reflection 1 PLUS, HP 700/92 and DEC VT102 emulation, or Reflection 7 PLUS, which adds HP 2627A color graphics.

enjoy the benefits of multitasking. Send us the manual title page from HP's Advancelink® or Terminal Program and a purchase order for \$125.* We'll rush you a copy of Reflection® 1 PLUS or Reflection 7 PLUS and add you to our growing list of satisfied and productive customers. The comparison chart on the attached card gives you

more reasons to trade-up to Reflection **today!** This trade-up offer is available from Walker Richer & Quinn and authorized dealers in Canada, Europe and Australia. For more information call Darcie Brintnall at (800) 872-2829 or (206) 324-0350.

Walker Richer & Quinn — with the commitment and resources to remain number one in PC integration technology.

Walker Richer & Quinn, Inc.

2825 Eastlake Avenue East, Seattle, WA 98102
(206) 324-0350, FAX: (206) 322-8151

*Add \$8.00 for shipping. Washington purchasers add 8.1% sales tax. Prices quoted are U.S. only.

D

**COMSAT
Laboratories
Explains How
To Solve
Connectivity
Problems.**

DESIGNING A LAN, PART 2

At COMSAT Laboratories, Microwave Technology Division, we recently assembled a new local area network (LAN) that has solved many of our connectivity problems. The network consists of an HP 840, numerous HP 300 Series computers and Macintosh computers. Users have access to all computers on the network.

In Part 1 of this series (see HP Professional, February 1989), the network configuration of Figure 1 was described in detail. In Part 2 I'll address assembling the network and IP (Internet Protocol). To understand the installation process and how the network operates, it's necessary to understand the method of addressing used by IP (called IP addressing). IP is part of TCP/IP. Every host within the network is assigned an IP address (a host is any computer in the network including CSs and Macs). Therefore, for communication to occur, the host originating the message must know the address of the destination host so it may address the message properly.

Each address has two parts, which I will call the network number and the host number. You can think of the network number as the zip code portion of the address and the host number as the street address.

Using this definition for an IP address, a network is defined as a collection of hosts that share the same network number within their addresses.

Each IP address consists of four bytes. The encoding of the network and host numbers within these four bytes varies as shown in Figure 2. Some addresses use one byte for the network number, leaving three for the host number. Others use three bytes for the network number, leaving one byte for the

host number. The encoding of the IP address, and therefore the network class, is determined by examining the first few bits of the address. If the first bit of the address is a zero, it belongs to a class A network where one byte is used for the network number and the remaining bytes are used for the host number. Similarly, if the first three bits are 110, the address is a class C address.

A class C network may have 254 hosts (the host numbers zero and 255 are reserved) because there are eight bits for the host number. In contrast, class B and class A networks allow 16 and 24 bits respectively for the host number. Thus, a class A network can have many more hosts than a class B or class C.

Similarly, there can be fewer class A networks than class C networks because there are more bits allotted to the network number in a class C network than in the class A network. This makes sense because you are more likely to have many networks with few hosts (class C) than you will have networks with large numbers of hosts (class A).

We can determine the class of a network by examining the first few bits of the address or by writing down the value of the first byte given the bit restrictions. For example, the first bit of a class A network must be zero. Therefore, the first byte must have a value from zero to 127 in a class A network. In a class B network, the first two bits must be 10; therefore, the valid values for the first byte are 128-191. Last, the first byte in a class C network can have the values from 192-223. The value of the first byte is important because of the technique used for writing IP addresses.

IP addresses are written by expressing the contents of each byte in decimal and using a period between each value (dot notation). The addresses 197.25.67.8 and 125.23.45.6 are examples



NETWORKING

Ken Fullett

of a class C address and class A address respectively. Using the information in *Figure 3* and comparing the value of the first byte (197 and 125 in the examples), the network class easily is determined and therefore the number of bytes used by the network number and host number. For the address 197.25.67.8, the network number is 197.25.67 and the host number is 8. In the address 125.23.45.6, the network number is 125 and the host number is 23.45.6.

Communication

The purpose of the IP addressing scheme is to allow communications among different networks. In *Figure 4*, there are three networks with network numbers: 197.30.42, 125, and 192.247.30. Between each pair of networks is a box labelled Gateway. The job of a gateway is to route messages between the two networks to which it is connected. The gateway accomplishes this by examining the network numbers of the messages. If a message with network number 125 appears on the B side of Gateway 1, it is retransmitted to the A side of the Gateway 1. Similarly, if a message with network number 192.247.30 appears on network 125, Gateway 1 ignores the message and Gateway 2 retransmits the message to its side D.

Consider the case in which a message destined for network N3 in *Figure 3* occurs on network N2. Gateway 1 might ignore the message if it is programmed to forward only those messages destined for network N1. We simply could tell Gateway 1 to forward any messages it finds on N2 that are destined for N3. However, every time a new network is added, we would have to reprogram all the gateways. Rather than explicitly programming each gateway, a simpler approach is to program the gateway to forward any messages that are *not* for the network on its B side.

Then, a message destined for N3 that originates on N2 is routed as follows: First, Gateway 1 receives the message on its B side and examines the

HP PASCAL/BASIC Network Software

UNLEASH YOUR POTENTIAL.

For years, you've used HP 9000 workstations. They're easy to work with, and some of your most valuable programs have been written specifically for them. Yet, there's a whole world of applications out there that HP 200/300 units won't run. And you certainly don't want to be left behind.

FUSION® Network Software (FNS) sets you free. Using the popular TCP/IP network protocol, FUSION will link your HP PASCAL-driven PWS workstations and BASIC Language Systems to a wide variety of PC's, mainframes, minicomputers, even supercomputers, in an easily manageable configuration. While preserving maximum flexibility.

Imagine, from your current HP 9000, being able to tap into the very best that the IBM, DEC and Sun worlds have to offer, along with those of more than 40 other manufacturers. Imagine every platform retaining its distinct characteristics. Best of all, FUSION's socket library Program Development System can help you create a storehouse of interactive, networkable applications in-house.

FUSION's powerful C-based architecture works well with standard HP Ethernet adapters. It features remote log-in, quick and easy file transfer and simple network management utilities. And Network Research Corporation provides exceptional customer support, customization alternatives, upgrades, training and aftermarket products.

It's a solution as rich with potential as nature itself. Experience for yourself the power of FUSION.



2380 North Rose Avenue, Oxnard, CA 93030
Toll Free: (800) 541-9508 ■ In CA: (805) 485-2700
FAX: (805) 485-8204 ■ TELEX: 297579 NRCO UR

FUSION is a licensed trademark. Other trademarks: HP, PWS, Hewlett-Packard; IBM, International Business Machines, Corp.; Ethernet, Xerox Corp.

FIGURE

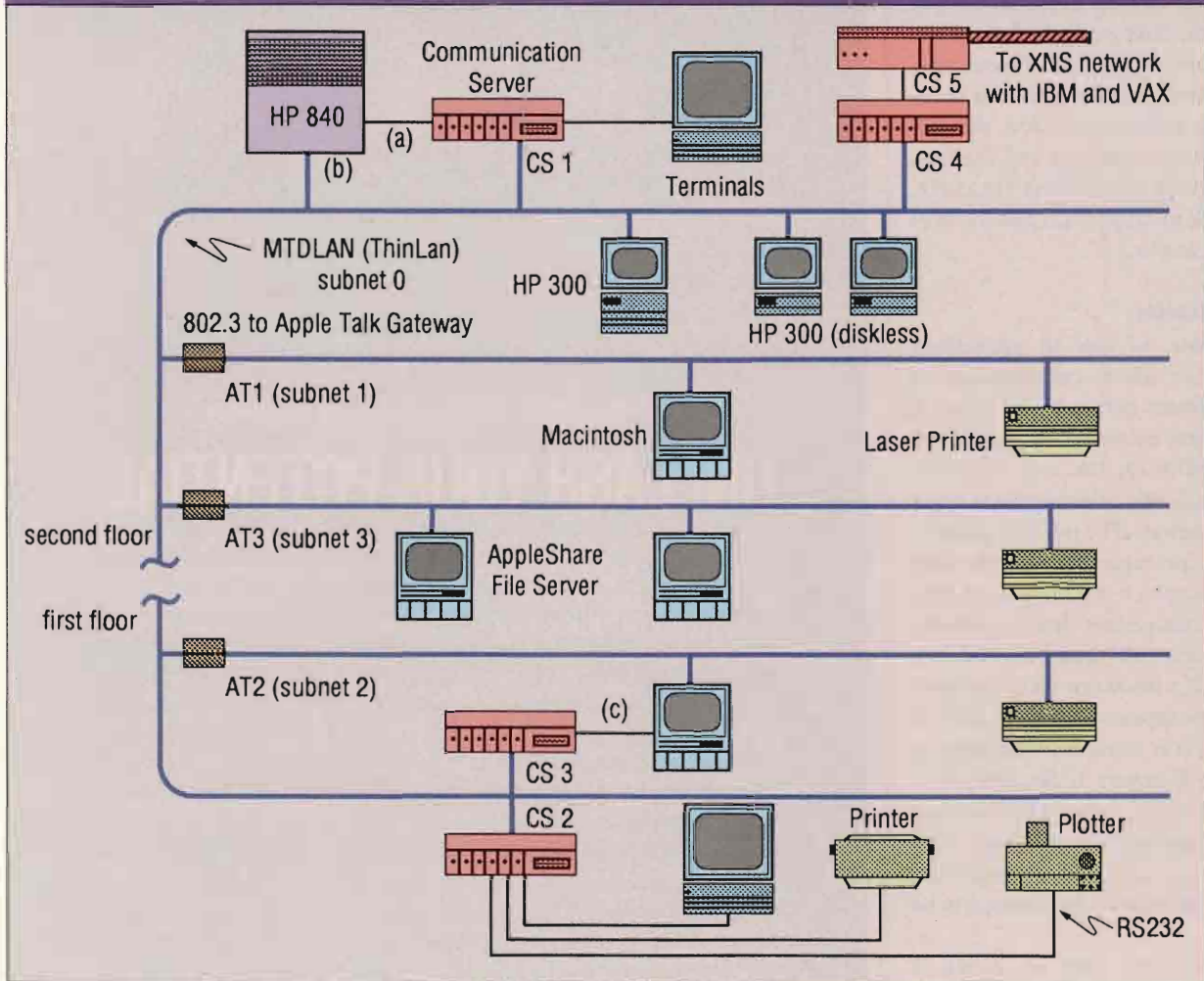

The network configuration of the Microwave Technology Division at COMSAT Laboratories.

network number. Since the Network number is not equal to that of N2, it forwards the message to N1. Next, Gateway 2 detects the message on N1 and forwards it to N3.

Gateways are available with many capabilities: some with the capabilities described here, others that may be specifically programmed to filter out traffic and still others that learn the addresses on each side simply by watching the messages that appear on each network.

The gateways in the sample net-

work are performing a routing function and are keeping traffic local whenever possible.

Subnetting

Another form of routing in networks is called subnetting. In subnetting, a network is divided into smaller parts, each called a subnet. Each subnet is a member of the same network because they share the same network number. Each subnet is identified by breaking the host number into two parts called the subnet and host id. I am using the term host id so as not to confuse it with the host number.

Figure 4 illustrates the address format for a class C network that uses subnetting. The network number is the first three bytes; therefore, there is only one byte (the host number) left to be used for the subnet and host id. We choose the number of bits to use for each. For example, if we have only two subnets, a single bit can be used to indicate which subnet. Similarly, if we set aside two bits for the subnet, there can be four subnets and so on. Figure 4 shows the example of using three bits for subnet addressing. This allows eight subnets (0-7) with 32 hosts per subnet,

The value of your data is only as good as your access to it.



© 1988

In a way, it's ironic. We invest millions of dollars to develop computerized systems to store information . . . data that is crucial to managing a successful business. Yet the sheer volume and variety of data that we have to store make it increasingly difficult to find the specific information we need to make decisions.

Executive Information Systems (EIS) are the latest approach intended to address the problem. In theory, an EIS should provide "easy access to individually specified mainframe information by non-technical end users."¹ In reality, it can't be done on the HP3000 without OMNIDEX.

OMNIDEX gives users the ability to instantly retrieve records based on multiple field and multiple set selection criteria, keywords and partial key values. Users can access information through all major report writers and with programs written in any 3rd or 4th GL, or use their PCs to retrieve summarized HP data directly into a Lotus 1-2-3™ spreadsheet using OMNIVIEW.

Reports that used to take hours to complete can be done in minutes. Critical information can be retrieved on-line in seconds. Never again will your users have to say, "I know that information is in here somewhere . . ."

DISC

Dynamic Information Systems Corp.

910 Fifteenth Street
Suite 640
Denver, Colorado 80202
(303) 893-0335

In Canada call:
1-800-267-9377

In Europe call:
(44)-372-386838

In Australia and New Zealand call:
(02) 484-3979

¹"The Three Pillars of EIS" by David Friend, August 1988

™ Lotus 1-2-3 is a registered trademark of Lotus Development Corporation

except for the first and last subnets (remember, all zeros and all ones are reserved by IP).

Figure 3, used earlier to explain IP routing, illustrates a network using subnetting. The only difference is that the gateways now are using subnet routing to determine how messages are routed instead of network routing. It is very important that the host number is encoded correctly to properly reflect the correct subnet; otherwise, messages will not be routed properly. This is no different from network routing where the proper network number was required.

Our network configuration shown in Figure 1 uses subnetting for message routing. As explained earlier, it consists of four subnets: one 802.3 network at subnet zero and three AppleTalk subnets at subnet numbers one through three.

The key to the Apple connectivity is the gateway, each connected to subnet zero and to an AppleTalk (AT) network. The addressing is established so that the zone number and the subnet number are the same. The FastPath gateways understand the AppleTalk protocol and thus, forward messages after packaging within an IP message onto subnet zero. The remaining FastPath gateways receive the IP message and forward it to their respective subnets after stripping off the IP packaging. Thus all Macs on the network can see all subnets and, therefore, all printers and the file server.

You can see that, because of the IP addressing and the use of subnets, the traffic isolation of the AT networks discussed earlier is achieved.

Our current network configuration is relatively recent and was brought about by three major events: the division decided to purchase the HP 840 for general use, a part of the division was moving to a new area, and HP was supporting the X Window System (HP Professional, January 1988).

During the design, we considered our needs and our existing equipment configuration, which consisted of:

- Three HP 9000 Series 300 computers inter-

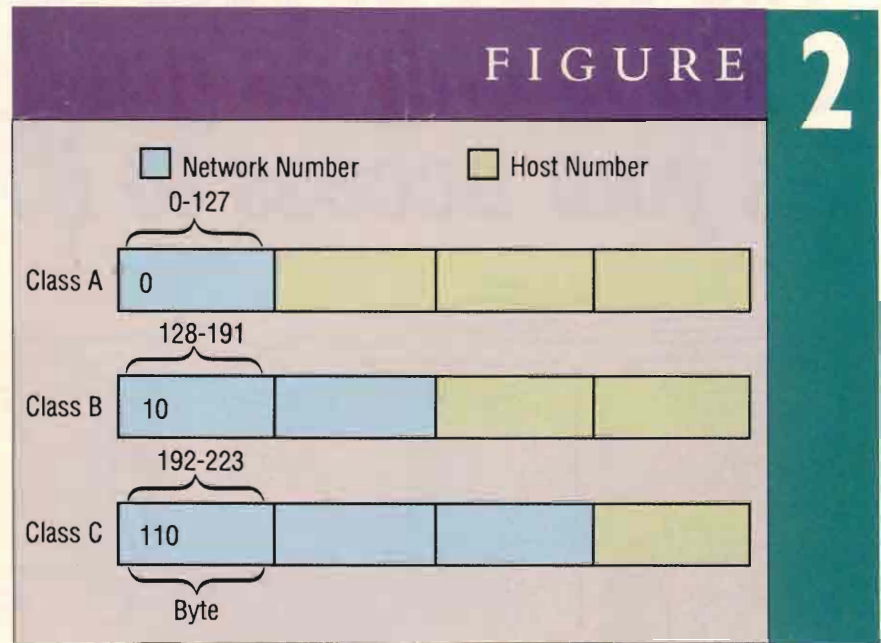

Network class A, B and C.

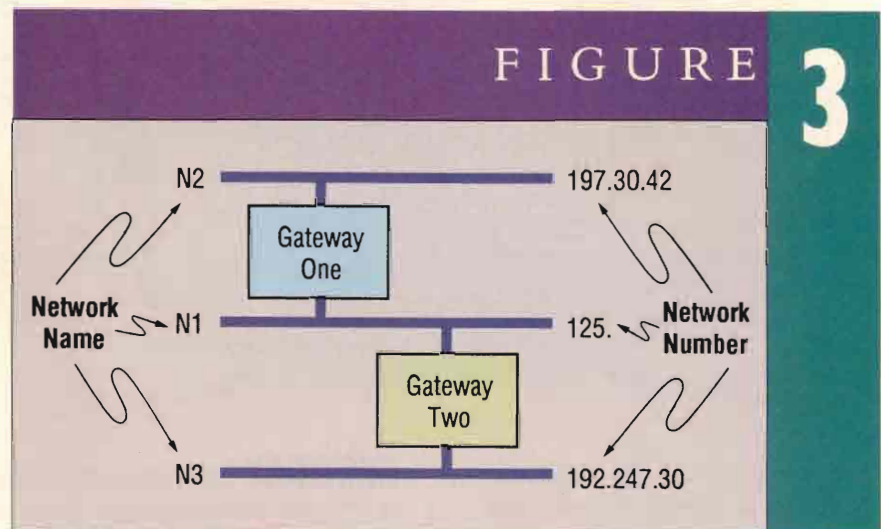

Network routing example

connected by an 802.3 network with TCP/IP (the discless nodes were added later).

- Many Macs connected via an AT network so they could share a single laser printer and file server.

- The Net1 network to which several terminals and Macs were directly connected.

This configuration did not allow the connectivity freedom we now enjoy.

The Components

We chose the various components of our configuration based on the existing

equipment, our needs, and the price and availability of the marketplace.

Our first search was for communications servers. After comparing two vendors, we chose the model CS210 manufactured by Bridge Communications.

Most communication servers are basically a specialized computer with many I/O ports and must be booted from a disc. The protocol they run (XNS or TCP/IP) is determined by the software they execute. The disc used for booting

The Consumer's Guide to Buying a C Compiler for the HP 3000.

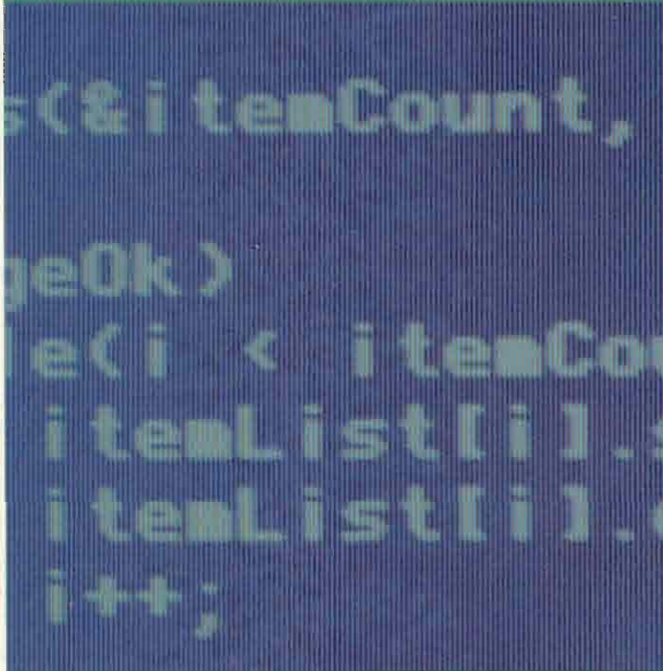

The release of Spectrum has sparked new interest in C among HP 3000 users. If you're adding a C compiler to your software shopping list, here are four criteria to consider.

- Is the compiler strictly ANSI-standard, ensuring the ability to run programs on both classic and Spectrum HP 3000s?
- Does it generate efficient, highly-optimized code?
- Does it work like all other HP 3000 compilers, providing accesses to the MPE file system and intrinsics and producing standard USL files?
- Does it provide a reliable programming environment through function prototyping?

There are four things you should know about C/3000™, the C language compiler from Tynmlabs.

Yes, yes, yes, and yes.

Tynmlabs Corporation • 811 Barton Springs Road • Austin, Texas 78704 U.S.A. • (512) 478-0611 • Telex 755820
Wick Hill Associates Ltd. • 42A-44 High Street • Egham, Surrey, U.K. TW20 9DP • 0784-38441 • Telex 268764
Tynmlabs-APPIC • 123 Rue de Petit-Vaux • 91360 Epinay sur Orge, France • (1) 64-54-87-37 • Telex 603409
Megatec Pty., Ltd. • 2 Brunswick Road • Mitcham, Victoria 3132, Australia • (03) 874-3633 • Telex 152692
Infosistemas Financieros S.A. de C.V. • Bahía de Guantánamo 79 • 11300 México, D.F. • 254-3274 254-3284

C 3000 is a trademark of Tynmlabs Corporation.

CIRCLE 165 ON READER CARD

3Com/Bridge Communications
2081 Shoreline Blvd.
Mountain View, CA 94043
CIRCLE 293 ON READER CARD

FastPath Gateways

Excelan
2180 Fortune Drive
San Jose, CA 95131
CIRCLE 292 ON READER CARD

Appletalk

Apple Computer
20525 Mariani Ave.
Cupertino, CA 95014
CIRCLE 291 ON READER CARD

found for connecting the FastPath is to configure it while connected to a single Mac. Then, before connecting it to the complete AT network, turn off all printers and Macs.

The NCSA TELNET program pro-

vided with the FastPath gateways is a little flaky when used with the multi-finder; however, it gets its job done supporting both TELNET and FTP.

During installation, the 802.3 portion of the network was easier to troubleshoot. The RG-58 cable (also called ThinLan cable) and its associated BNC connectors are more robust than the that used within the AT networks. Most of the problems encountered were associated with poor connections within the AT networks because the connectors were easily pulled apart.

Assembly of the RG-58 cable is much faster because the BNC connectors are easier to attach than the multipin connectors associated with the AppleTalk.

There have been no problems with the 8802.3 portion of the network. There were a few problems with the Apple portions of the network because of con-

nectors coming apart or connectors that were not properly replaced when a Macintosh was moved. In general, the network has been running flawlessly for about seven months.

If you need a network because of distances or connectivity, I strongly recommend that you pursue the technology. In our case, everything has fallen nicely into place. We were very careful to avoid the claims of the marketplace. We located all the software and hardware and even tested components before purchase with our existing equipment. With the same care, you too can be successful. —Ken Fullett is a scientist in the Transponders Dept., COMSAT Laboratories, Communications Satellite Corporation, Clarksburg, MD.

Would you like to continue to see articles on this topic?
Circle on reader card
yes 344 no 343



Ambroise Paré
1510-1590
French surgeon. The most celebrated of the Renaissance. He reformed the treatment of gunshot wounds by abolishing cauterization with burning oil.
...the tradition lives!

SESAME the HP3000 Security System

New world discovers old. Created with the care and genius of French science and technology, SESAME sets the standard of excellence for the new world. The threat of virus, theft, tampering, or friendly error has met a mighty foe.

SESAME provides:

- Comprehensive protection against unauthorized sessions
- Integrated access control for large and small networks
- Automatic logoff of inactive sessions
- Easy routing of reports to local printers

Please call or write today.

MIGHTY KEYS
1720 Section Road, Suite 111
Cincinnati, Ohio 45237
513-731-4966

Distributors:

W. Germany MANDATA (02151) 590014	United Kingdom SYSTEM SOFTWARE 44 905 794646	Spain SCAN 402 4099	Congo SERIC 835034
--	---	----------------------------------	---------------------------------

MIGHTY KEYS
System Software Specialists
123, rue de Petit Vaux
F 91360 ÉPINAY-SUR-ORGE/France
(1) 64 54 82 32

CIRCLE 128 ON READER CARD

DIRTY TAPES?



MAGNETIC TAPE CLEANER/REWINDER

PERIPHERALS

A High Technology Company

1363 Logan Ave.
Costa Mesa, CA 92626
Headquarters 714-540-4925
Outside CA. 1-800-468-6888
FAX 714-540-2026

CIRCLE 131 ON READER CARD

INSTALLING CIM AT ROCKWELL

**Using
Networked
HP CAD
Workstations
Improved
Quality And
Saved Money**

Rockwell International began its CIM project with a design process where design throughput largely was dependent on the queue time of engineering support activities such as drafting and manual information transfer. The CIM project ended in a process closely tied to the actual productivity of the engineers with few wait queues in the design and information transfer process.

The most common type of communication system is the telephone network. In general, a telephone network accepts information created at a subscriber's location and transfers the information to a central office over copper wire, radio, or more recently, lightwave media such as fiber optics.

At the central office, information in either analog or digital form is combined with signals from other subscribers and routed to designated locations using long-distance radio or lightwave communication equipment. In the combining process, information is routed to designated locations using switching and multiplexing techniques.

This creates bundles of information that can exceed the equivalent of over 16,000 voice channels per radio or fiber optic transmission path.

"Racks" for switching and transmission purposes form the backbone of this communication network. The premier rack, LTS-21130, is among the products made at Rockwell's Network Transmission Systems Division (NTSD).

Product Design

Each rack of equipment may include hundreds of different parts, in literally thousands of combinations. Rockwell design engineers must determine the configuration of the network,

systems, racks, subsystems, modules and inter/intra rack cables. The design process requires many system, site and equipment documents for the customer.

The engineer also must present detailed information to manufacturing to specify the configuration of each rack. Because of the modularity of the telecommunication equipment, the rack is assembled in the factory or sent to a customer for assembly onsite. Test procedures must be specified for factory testing and custom procedures for site and system acceptance testing in the field.

The systems engineering department at Rockwell was generating over 400 custom drawings per month, representing over 75 percent of the documentation generated by the Dallas divisions of Rockwell. Laborious cut and paste and redrawing methods of transferring and reusing graphic information by different organizations had become unacceptable.

Increased sales along with customer demands for shorter lead times began to strain the existing methods of doing business for the systems engineering department. A new method of handling this volume urgently was needed.

A Mix Of Drafting Tools

Before the start of the project, computerized drafting tools from ComputerVision, (Bedford, MA) were driving productivity improvements, but rapid growth in capacity required the hiring of more draftsmen to get the job done.

Meanwhile, engineers were still cutting and pasting the initial copy of each drawing. Documentation short cuts to maintain throughput began to occur, resulting in the decrease in the accuracy of the system designs. Also, design and installation decisions were



CIM

David A. Lindberg

ARTESSA®

3000

The application builder for the HP3000

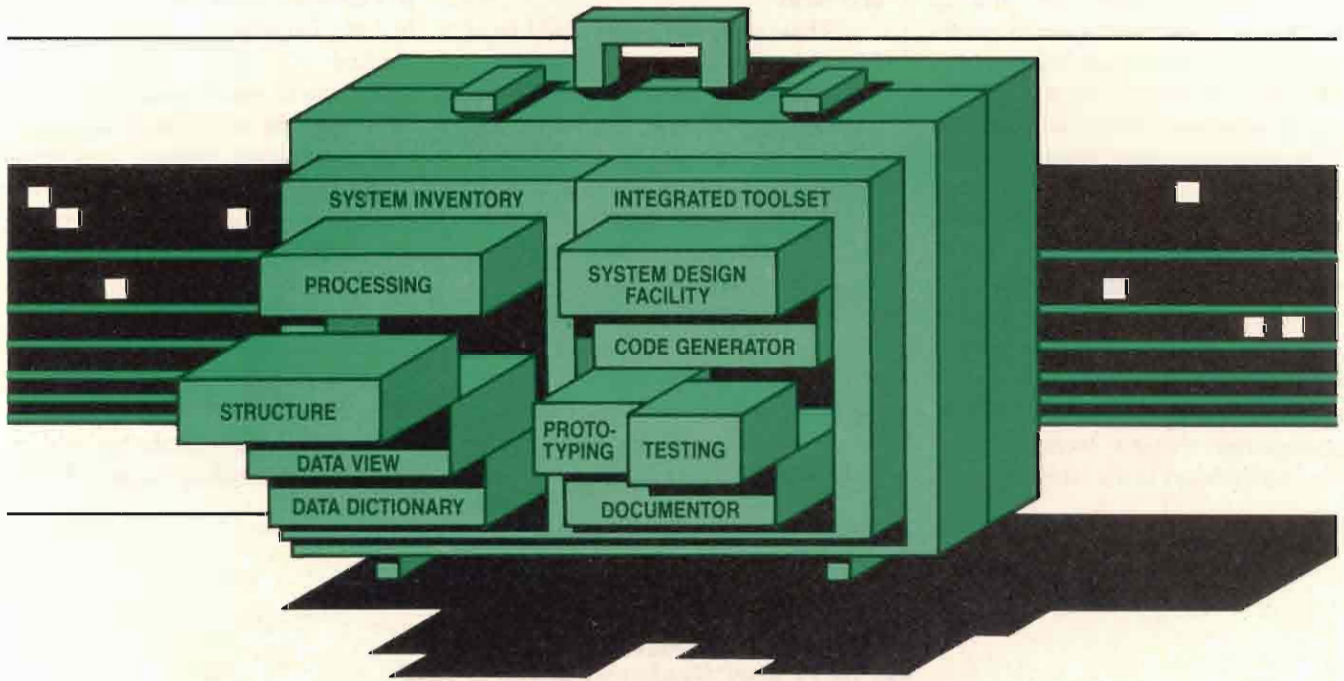

Our open and shut C.A.S.E.*

*Computer Aided Software Engineering

▼ Can you afford to...

- tie up 80% of your resources on maintenance?
- finish projects up to 100% over budget and behind schedule?
- lose business opportunities because of obsolete or faulty applications?
- pay for costly "run-time support" for programs that "crawl"?

▼ When you can have today...

- **QUALITY ENGINEERED** applications, designed to accommodate future changes now.
- **INCREASED PRODUCTIVITY** in development, through re-usable components and a powerful set of tools.
- **USER SATISFACTION** with easily maintainable, reliable and highly featured applications.
- **PERFORMANCE** that only compiled COBOL can give, at *no extra cost*.

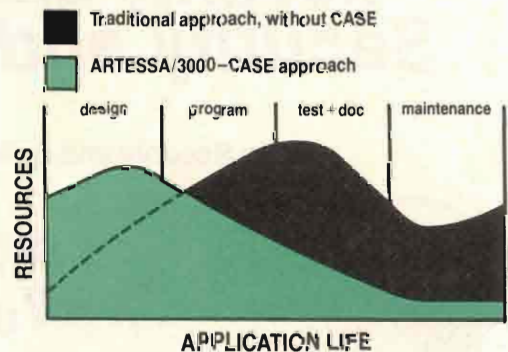

Call or write today RAET 1-800-338-3772

RAET Software Products BV, P.O. Box 4077, 6803 EB Arnhem, The Netherlands. (085) 24 62 18

New England
Wescom Systems, Inc.
(617) 769-4344

Mid West
O'Brien Downs Systems, Inc.
(513) 891-9300

Canada
COA Computer Systems, Inc.
(416) 333-0611

Belgium
NV RAET Belgium SA
(02) 720-9060

South East
Quality Consultants, Inc.
(404) 980-1988

South West
Information Systems Professionals, Inc.
(714) 778-1818

Australia
Field Technologies Pty. Ltd.
(03) 417-5661

UK
Assyst Computer Services Ltd.
(0525) 38 26 26

slipping in a counterproductive manner to organizations further downstream in the overall process.

After standard drawings created by product design were cut-and-pasted together by the system engineers to form the specific design documents needed by the customer and manufacturing departments, the original documents would be submitted to drafting for professional redrawing, with a nine- to 14-day throughput.

After release of the drawings to the documentation control department, industrial engineers manually would cut-and-paste systems engineering drawings to derive assembly procedures for the manufacturing assembly process.

The drafting department was unable to handle this growing volume of work. With documentation being done at least three times using different tools, engineering changes were frequent. Because of delays in the communication

loop, design changes would occur later in the manufacturing process, creating additional and more expensive delays in the overall process throughput.

Software using knowledge-based "expert system" programs was being developed in house to help select materials for the equipment subsystems and racks.

These programs were called List of Material (LM) Generators. Though they were developed on central host computers, they lacked the associated graphic information needed for final documentation of the system. This made it difficult to match the drawings with the bill of materials (BOM) in the inventory control system.

Simultaneously, another project to develop programs was under way to automate the design of the radio and lightwave transmission links. The design of 30-mile radio links required the system engineer to perform tedious

calculations to determine antenna sizes, tower heights and transmitter power requirements. This effort, to support an engineering project in Saudi Arabia, strained the human resources of the design team, but the investment in time and hardware was needed.

A Network Emerges

In 1982, four HP 9845 computers networked via HP's Shared Resource Management (SRM) systems were installed to build and maintain a transmission engineering database. The computers quickly computed radio tower and antenna dimensions for a series of 500 radio relay sites linked by microwave radios.

The HP hardware afforded a user-friendly combination of graphic and alphanumeric data to use in selecting radio frequencies, drawing geographically accurate maps, producing field installation documentation, and calculat-

Security and System Management
Security and System Management
Security and System Management
Security and System Management
Security and System Management
Security and System Management
Security and System Management
Security and System Management
Security and System Management

Bring Security and System Management out of the *SHADOWS* with ...



SECURITY PLUS.....
It will grow with your system!



CALL FOR A SELF-PACE DEMONSTRATION NOW!

UNIFIED SOFTWARE SYSTEMS
6551 Loisdale Court, Suite 400
Springfield, VA 22150-1854
(703) 922-9800

USS MARKETING, INC.
5666 La Jolla Blvd., Suite 8
La Jolla, CA 92037
(619) 454-8441

CIRCLE 139 ON READER CARD

SAYS WHO?

MAYBE SOMEBODY'S TRIED TO TELL YOU THAT BACKING UP DATA DURING NORMAL SYSTEM USAGE CAN NEVER WORK.



SAYS THEM.

THAT MIGHT COME AS A SURPRISE TO THE HUNDREDS OF COMPANIES WORLDWIDE WHICH ARE USING AND LOVING ONLINE-BACKUP/3000 FROM ORBiT SOFTWARE.

"ONLINE-BACKUP/3000 saves us 44 hours a month in system productivity," says Darwin Hatch, Computer Operations Supervisor at Union Camp Corporation.

"I used to spend a lot of my own time handling backup with BackPack™. Now we have a staff person who can take care of the whole thing — ONLINE-BACKUP/3000 is a great time-saver for me," says Kay Shair-Ali, MIS Operations Supervisor of Marine Terminals Corporation.

And now, just released — ONLINE-BACKUP/3000 version 2.12! The newest version of ONLINE features zero down-time backup for IMAGE files plus true disk-to-disk backup for faster restores plus a variety of other new features.

Find out for yourself. Call to give us the "thumbs up" to send your free, no-risk demonstration package of ONLINE-BACKUP/3000.

online **BACKUP**³⁰⁰⁰

ORBiT

Software Support Throughout
the HP Community

BackPack™ is a product of Tynlabs Corporation

CIRCLE 130 ON READER CARD

ORBiT Software (USA) Inc., 319 Diablo Rd., Suite 218, Danville, CA 94526
(800) 6-ONLINE or (415) 837-4143, FAX (415) 837-5752

ORBiT Software
GmbH (Berlin)

ORBiT Software
(UK) Ltd

ORBiT Logiciels
(France) Sarl

ORBiT Utilities
(Benelux) N.V.

ORBiT Software
(Scandinavia) AB

Eight good reasons that make Omnispooler & Infonet your number one choice for spooling.

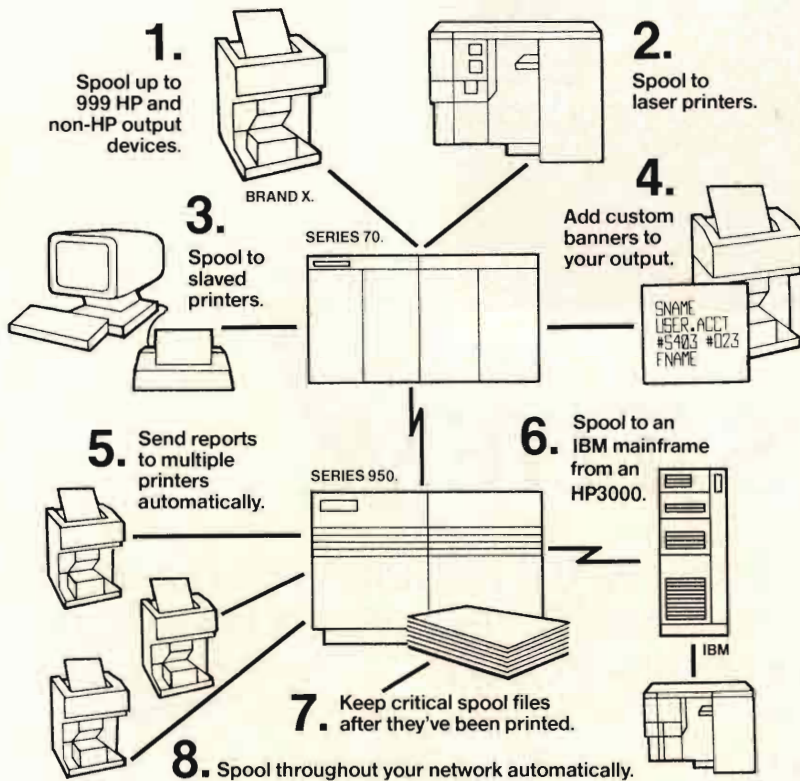

You've got a lot invested in your hardware, and it's only natural that you want to use it to its fullest. So, when you told us that you needed a sophisticated spooler that would let you send print files to any printer anywhere in your company, we listened, and developed OMNISPOOLER & INFONET.

Whether you run a single HP3000 shop or a multi-machine network, OMNISPOOLER & INFONET give you unprecedented control over all aspects of your printing operations. No matter how many systems or printers you currently have or are planning to add to your network, OMNISPOOLER &

INFONET have the flexibility to handle your requirements. Carolian even has a module that allows you to automatically send reports from the HP3000 to your IBM. OMNISPOOLER & INFONET also give you the option to centralize or distribute control of printing so that you can organize your entire data center for the highest level of efficiency.

With OMNISPOOLER & INFONET you can be sure that you're making the best use of ALL your hardware and your staff now and in the future.

At Carolian we listen to you. 1-800-263-8787

CAROLIAN

CANADA -- Carolian Systems International Inc. (416) 673-0400. Telefax (416) 673-7030. SINGAPORE -- Singapore Computer Systems Pte. 775 2477. MEXICO -- Nunez, Santa Cruz Y Asociados, S.A. 545 31 07.

ENGLAND -- Nike Computers Limited. (0902) 851381. SWEDEN -- Datalaget I Vaxjo AB. 470 810 50. THE NETHERLANDS -- Quant Systems. 02503-40334. ISRAEL -- Softkol. 3 413762. ITALY -- Sele Sistemi S.p.A. (02) 8527. FRANCE -- Sages SA. 1 47 37 55 55. BELGIUM -- Sages Benelux. 56 41 83 99.

CIRCLE 110 ON READER CARD

ing end-to-end system reliability for selected video and message routes in the network.

Islands of automation were starting to crop up to solve specific problems in the design process, however, to reduce throughput time significantly, Rockwell sought a more flexible system to couple tightly the overall design-to-manufacturing cycle over a network of computer workstations.

By the fall of 1983, the existing HP computers formed a nucleus of a prototype system, augmented by newer HP 9816 and 9817 computers.

Personal computers were ruled out because they lacked the high-end computational power, high-resolution graphics and large memory requirements necessary for Rockwell's applications. A strong networking structure also was needed between workstations and the departmental DEC and IBM systems to manage the information flow.

So, the development of Rockwell's Telecommunication Engineering Network (TEN) was initiated in the fall of 1984. Departments such as product development and manufacturing engineering were included to facilitate the sharing of the engineering data (see Figure 1).

A Pilot Program

Transmission systems engineers were the subject of the first pilot program to use HP engineering workstations as an integral part of the design process. In the spring of 1985, the systems engineering staff was trained to use the new systems, and the equipment was placed on-line in a network configuration. The network supported word processing, project scheduling, information retrieval and 2-D graphics. As a custom part of the graphics program, an integrated rack designer that included an LM generator and equipment rack graphics generator was created in house (see Figure 2).

Cut-and-paste work with engineering drawings decreased radically as documents were created and moved electronically between engineering functions. Support groups serving

FAX / 3000



THE POWERFUL NEW SOFTWARE THAT SENDS
FAXES DIRECTLY FROM YOUR HP3000.

USE FAX/3000 TO SEND:

- Letters generated in Word Processing
- Invoices
- Purchase Orders
- Special Forms
- Accounting Reports

 STR SOFTWARE COMPANY
3601 SWEETHORN
FAIRFAX, VA 22033

Call: (703) 689-2525

Fax: (703) 689-4632

systems engineering such as product applications engineers and the document control department were linked through nodes on the workstation network to share data electronically.

The network provided data transfer at rates of 18 kilobytes/second (kbps) via SRMs between workstations, and 40 kbps via Ethernet between the VAX computers and HP Series 500 computers, typically LM information to and from systems engineering's VAX computer. This phase included 22 HP Model 217 engineering computers.

Network Expansion

By late summer of 1985, the program had sufficiently shown its effectiveness that Rockwell management approved the acquisition of 42 more HP Model 310 workstations for the systems engineering department, and extended the network into industrial engineering and systems test areas of manufacturing.

Completion of this phase ensured

the availability of two workstations for every three engineers. Within a few months, more than 95 percent of systems engineering documentation was being done electronically for relay to the document control department.

In the spring of 1985, no drawings were created by engineers; by the end of 1986, more than 400 drawings per month came directly from engineers.

The engineering network has grown to over 10 clusters of engineering workstations networked via HP SRMs as shown in *Figure 3*. Further, to isolate the user from the detailed operation of the system, UNIX system HP 9000 Model 500 computers used as network managers controlled the flow and storage of information on the network.

The network managers also provided daily backup and archiving functions for each of the engineering clusters and acted as an intelligent gateway into other computing resources within NTSD, including Ethernet links to other

buildings using Rockwell-manufactured 18-GHz microwave radios. The network managers oversee the release and storage of engineering documents and service requests by the users to retrieve electronic copies of documents stored on-line (see *Figure 3*).

Engineers work in project groups using diskless HP 9000 Model 200 and 300 computers as engineering workstations networked via SRMs to share access to peripherals and discspace. Each workstation is provided with high-resolution color monitors for graphics presentation and a second monochrome display for simultaneous presentation of status and LM information. Local HP Thinkjet printers, provided at each workstation, print draft copies of text and graphic information.

HP Model 200s and 300s with an SRM link are used in the manufacturing process to control the system testing of the modules and equipment racks.

The graphics and rack designer

MEGAMEMORIES™

When you think
of memory,
think of



WE GIVE YOU MORE—

- ★ Savings up to 60%! No one else even comes close.
- ★ Memory—½ to 16 Meg!
- ★ Supported Models—12 different HP 9000 Series 200/300 computers.
- ★ Service—2 year warranty and 90 day money-back guarantee.

NEW! Upgrade Your Series 350 to a full 16 Megs!

MARTINSOUND TECHNOLOGIES has developed an affordable method of expanding the new HP Series 350 computer from 8 Mb to a full 16 Mb of on-line RAM memory. This expansion maintains the quality standards you expect of your HP 350 and achieves the full performance that MARTINSOUND MEGAMEMORIES products are known for, worldwide.

See your local MARTINSOUND TECHNOLOGIES dealer, or

CALL US TODAY 818-281-3555



"American Built Quality and Service Since 1971"

Martinsound Technologies

1151 West Valley Boulevard, Alhambra, CA 91803-2493 FAX: 818-284-3092

CIRCLE 126 ON READER CARD

FIGURE 1

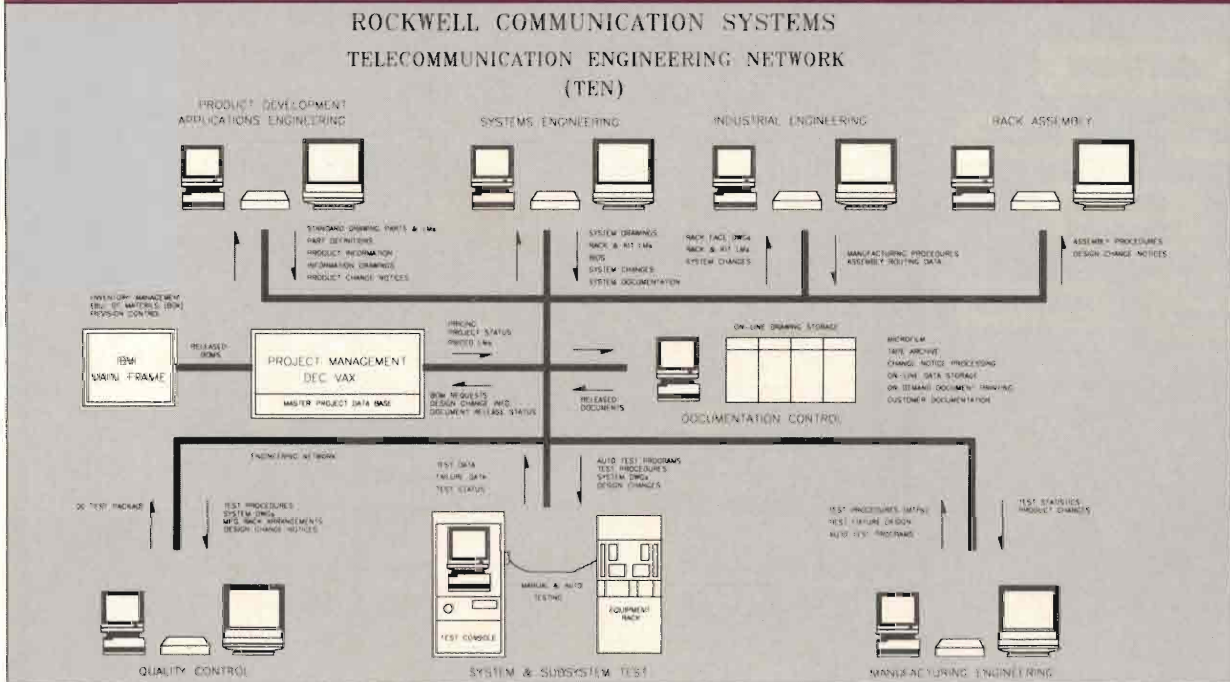

TEN Information Flow Diagram

FIGURE 2

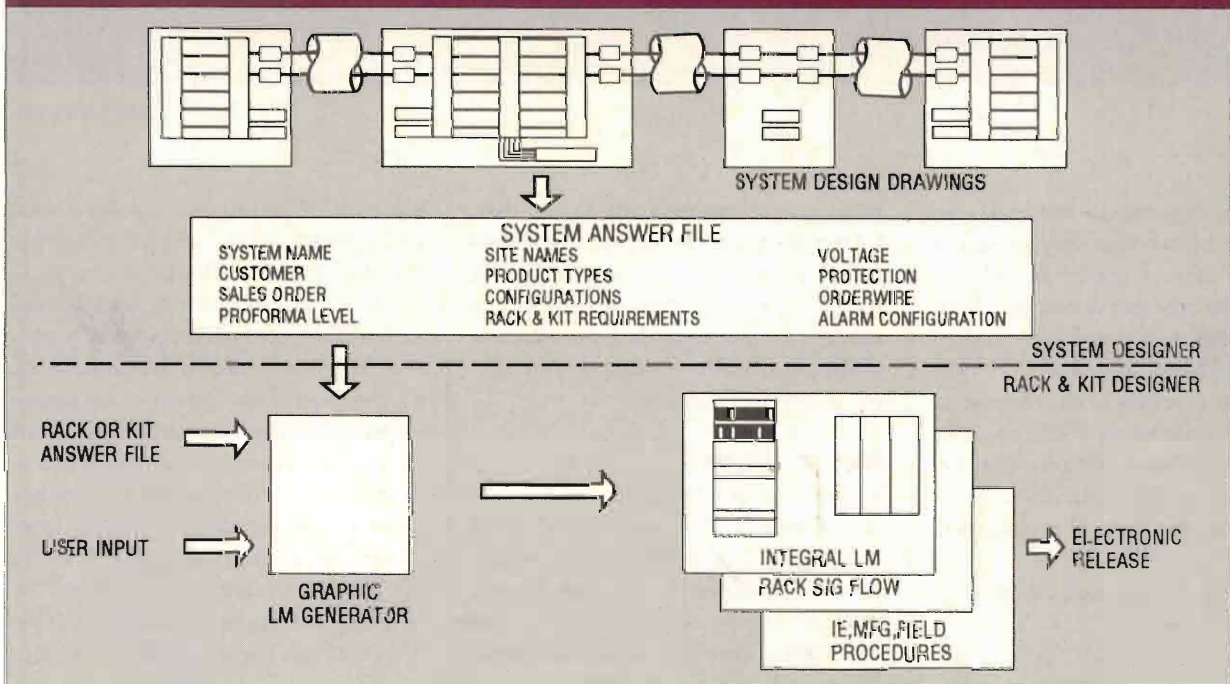

System And Rack Designer

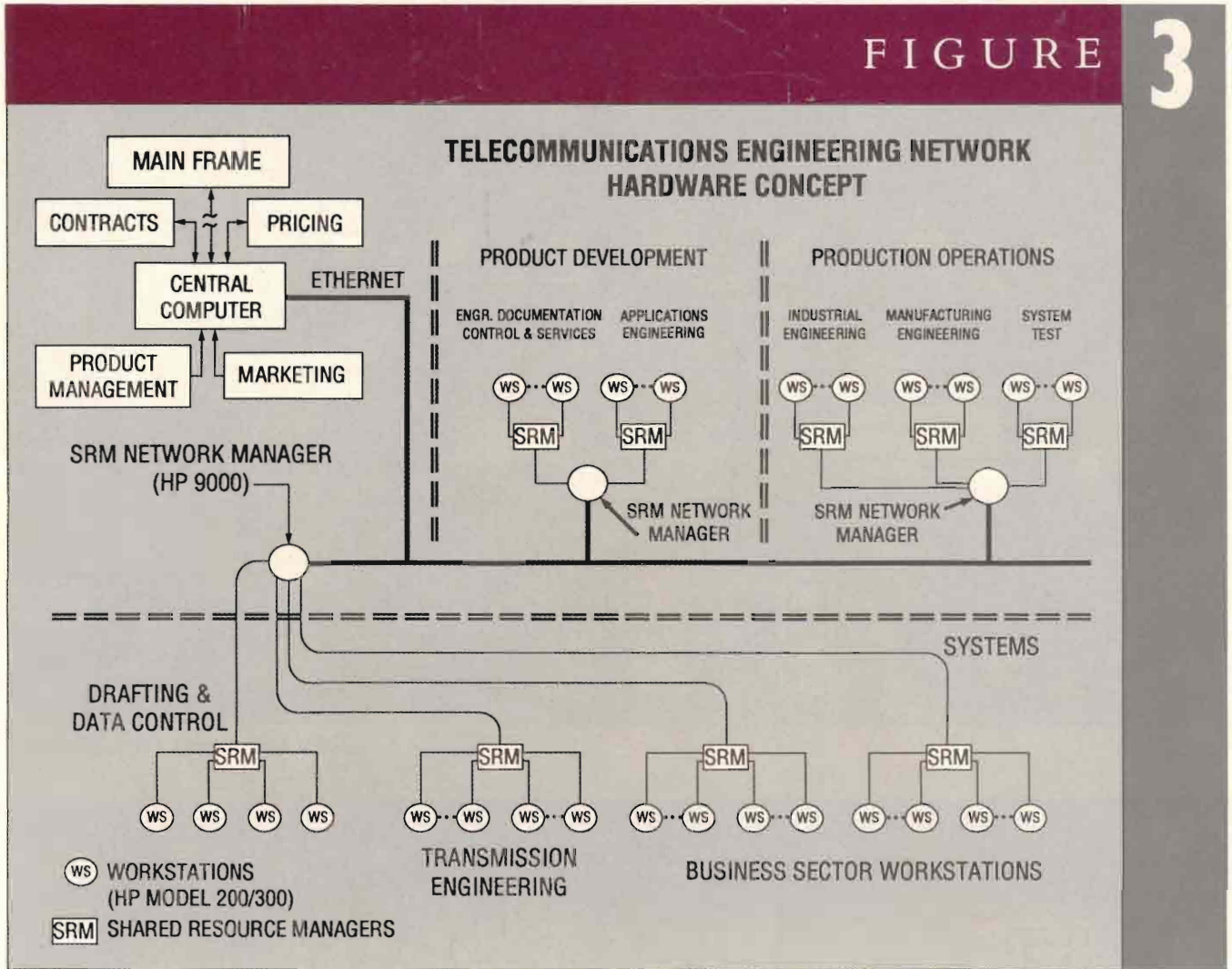

TEN System Layout

software were created in-house to ensure a tight link between the generation of the rack lists of materials and the creation of the rack face drawings. User-friendly interfaces also were provided to minimize keyboard inputs and provide menu lookup to retrieve stored drawings and word processing information. Third-party software was provided for word processing and spreadsheet functions to compliment the technical software.

The network and application soft-

ware is fairly transparent to the user. Information can be released or transferred to a co-worker's mailbox by menu selection. LM information is transferred to or from the host computer programmatically via part number entry at the workstation.

Human Factors

The initial implementation of the system was preceded by two weeks of intensive training by the developers of the applications. Reactions to the new system were mixed; the initial feeling was that the regular flow of work was being disturbed. Some tradition-bound employees resented it. Their routine

methods of getting the job done were being changed by people somewhat removed from the day-to-day tasks.

Integration of new systems started slowly. New tools were supplied to personnel who demonstrated positive attitudes toward the system — the champions. This accelerated as more staff realized the power of the system and as their functional managers supported additional workstations. In fact, after several weeks of getting acclimated to the new environment, competition for new engineering workstations became quite spirited. Some problems ensued in

supplying enough workstations to meet the overall demand.

As the CAD activity increased, constant change was occurring. The two-way exchange of drawings between drafting and engineering became less critical as less drafting time was required. Drafting personnel were moving into network support activities as user support and system maintenance teams. Others were moving into the systems engineering department and becoming engineering technical aides to support system designs. Drafting activities were becoming part of the engineering design activity.

Dramatic Improvement

Automating a process is far different from simply adding computer hardware.

Generally, the underlying process must change dramatically before the benefits of automation can be realized. Once that happens, improvements similar to the following may be achieved:

In 1985, the average throughput for engineering designs from customer order to documentation release to microfilm of the complete project was 43 days. This process required six steps:

- engineering sketch of design
- drafting hardcopy
- engineering review
- drafting revision
- engineering release, and
- photograph for microfilm and hardcopy storage.

By 1986, the system including many engineering workstations, and the same process had been modified to a rather different list of six steps that took only 24 days on the average:

- engineering rack design, including the automated rack drawing and LM generator
- drafting plot and check
- engineering electronic revision
- engineering electronic release
- drafting final check and drawing plot and
- photograph for microfilm and hardcopy storage.

During 1987, the number of engineering workstations doubled over the 1986 number and the process caused

a dramatic drop in throughput time to less than a five-day average, including:

- engineering rack design
- electronic review
- electronic documentation release, and
- electronic creation of microfilm, with no hardcopy storage.

The new process now was taking

far fewer man-hours and was completed in one-eighth the time it took two years before and resulted in a higher quality product. The combination of workstations with sophisticated 2-D graphics designed by Rockwell has produced significant long-term results.

Once the new system had been im-

Arkwright Laser Film and Laser Labels

SPORTS PROGRAM

Line-Up

FILE: SPORTS

FIRST CHOICE OF COMMUNICATIONS PROFESSIONALS

Overhead transparency films and labels designed especially for your laser printer.

OVERHEAD FILMS

- High resolution, superior stability
- Paper backed, .004" or .005" thickness
- Clear, blue or yellow-tinted styles
- Never cracks, buckles or smears

LASER LABELS

- NO-JAM design for multiple feeding
- 33, 24 or 8 label formats

For more information on these or any of our other fine products call or write: Arkwright, Incorporated, Main Street, Fiskeville, RI 02823. **1-800-942-5900.**

Arkwright

CIRCLE 185 ON READER CARD

With Type Director And Your LaserJet, You've Got A Whole New Avenue To Explore In Producing Documents.

Great typefaces. All the top art directors on Madison Avenue use them to help their ads grab people's attention.



And now, thanks to Type Director™, you can use them to help get the same kind of attention for your documents.

Co-developed By Hewlett-Packard. Type Director is the fastest, easiest-to-use font generation program you can own for your PC. A joint development of Hewlett-Packard and AGFA Compugraphic Division, it adds remarkable power to your LaserJet® printer to produce documents that look like they were prepared by communications specialists. It's ideal for all word processing and desktop publishing applications from the simplest memos to multi-page newsletters.

Compugraphic. One Of The Biggest Names In Type. When you think about it, it shouldn't come as a surprise. After all, AGFA Compugraphic is a supplier of typefaces to top advertising agencies, printers and publishers everywhere. Its typeface library is the biggest and best in the world, with over 1700 typefaces.

The Big And The Small Of It. A high-performance scaling technology found only in Type Director lets you make each typeface bigger or smaller until it's the exact size you want, from a tiny 4 points to a huge 200 points. But no matter what size you finally do decide on, each character will be crisp, clear and handsome.

We've Seen To It That There Are No Surprises.

When you're using Type Director, you see the characters on your screen exactly as they'll appear in your output. There are no surprises when you print out the results. And you get the fonts you need in just a few moments—decidedly more quickly than with any other software available today.

You'll Wonder How You Managed Without It. What is Type Director's impact on the fonts you're using now? Not to worry. Type Director will easily manage any "soft fonts" you may have as long as they're Hewlett-Packard LaserJet compatible. (Most are.) By converting to

Type Director, you protect your investment while making your desktop publishing system much more flexible and useful.

Type Director Does It All.

Think about it. Type Director lets you generate characters, monitor and manage your library of typefaces, automatically install them in your application, and immediately send them to your printer—all by touching just a few keys.

Learn By Doing, Not By Reading. Type Director is incredibly

Type Director Compatibility Information.

Type Director is fully compatible* with the following:
COMPUTERS: IBM XT, AT, Personal System/2 and compatibles with hard disk, 640K bytes RAM, running MS-DOS or OS/2.
PRINTERS: Hewlett-Packard LaserJet PLUS; LaserJet 500 PLUS; LaserJet 2000; LaserJet Series II; LaserJet II D and compatibles.
APPLICATIONS/ENVIRONMENTS: Aldus PageMaker 1A and 3.0; Xerox Ventura Publisher 2.0; Microsoft Word 4.0 and 5.0; Microsoft Windows 2.03 and 2.1; WordPerfect 5.0; Other software programs supporting LaserJet "soft fonts".
DISPLAYS: VGA; CGA; EGA; Hercules Monochrome; AT&T 6300; Xerox PC Full Page Display; WYSE 700 Graphics; Compaq; Monochrome; Hi Res Monitor (96x96); Hi Res Monitor (100x100).

*For compatibility information on unlisted printers, displays and applications, phone 1-800-873-FONT.



simple to use. It's entirely menu-driven, so there's no thick manual to have to hunt through. All you do is respond to the prompts on the screen. A built-in HELP function handles any questions that may arise.

Go Creative With Your Documents Now. You don't have to wait any longer. Your documents can

Save \$455 On Our Type Director Debut Edition.

Priced separately you'd pay \$680 for Type Director and our Debut Edition of typefaces, but order now and they're yours for only \$225.

Here's what you receive at one great price:

- Type Director Font Management Program
- Vol. 1 Four typefaces from the CG Times family
- Vol. 2 Four typefaces from the Univers family
- Vol. 3 From the Decorative collection:

Park Avenue
Dom Casual
Uncial
Brush



have that distinctive, professional, creative edge that gets attention now. All it takes is Type Director. And all it takes to get Type Director is visiting your local Hewlett-Packard dealer, returning the order form adjacent to this ad, or calling our convenient Type Director hotline right now at 1-800-873-FONT.

AGFA 

AGFA COMPUGRAPHIC DIVISION

Type Director is a trademark of Compugraphic Corporation. Ventura Publisher is a registered trademark of Ventura Software, Inc. Microsoft Windows, MS-DOS, and Microsoft Word are registered trademarks of Microsoft Corp. CGA, EGA, and VGA are trademarks of International Business Machines Corporation. Hercules is a trademark of Hercules Computer Technology. Wyse is a registered trademark of Wyse Technology Inc. Hewlett-Packard LaserJet is a registered trademark of Hewlett-Packard Corporation. PageMaker is a registered trademark of Aldus Corporation. WordPerfect is a registered trademark of WordPerfect Corporation. Other brand or product names are trademarks or registered trademarks of their respective holders. © 1989 Agfa Corporation.

Imagen

Imagen Corp.
2650 San Thomas Expressway
Santa Clara, CA 95051
CIRCLE 279 ON READER CARD

ComputerVision Corp.
100 Crosby Dr.
Bedford, MA 01730
CIRCLE 280 ON READER CARD

plemented, engineers could produce all of the necessary documentation directly from their workstations, creating both graphic and text information and releasing the documents into the documentation control system. Released documents then could be retrieved by ordering electronic or microfilm hard copies of documents without moving from the workstation.

Before 1984, systems engineering increased its productivity by an average of 11 percent per year. After the addition of engineering workstations, productivity increased by 22 percent for the next three years.

Rockwell's analysis projected a payback for the total system of 2.2 years, with a return on investment of 105 percent. Actual numbers for this period turned out to be a full investment payback in two years with 110 percent return on investment.

The payback was based on the systems engineering department alone and did not include the overall savings to other departments, whose benefits were less tangible but no less real.

Drawing production has reached a volume of over 1,000 drawings per month, with more than 40,000 drawing sheets being maintained on-line with less than a two minute retrieval time for the engineer.

In Retrospect

Two years ago, NTSD faced rising costs in supporting the systems engineering, design and documentation and manufacturing of its systems. The management team felt it was imperative to ex-

periment with a different approach.

Productivity improvements exceeded expectations, with average project design throughputs being reduced below one week. Designs became more consistent with increased volume of documentation. The experiment showed that significant improvements can be made in employee productivity and design throughput by placing workstations on engineers' desks and providing electronic access to information systems.

Continual advancement in networking and operating systems will require the continual upgrade of hardware software and operating systems. To provide the engineering staff with the latest in software support, UNIX operating systems such as HP-UX are being studied.

At the start of the project, a UNIX operating system for the workstation was not selected because of cost and performance of graphic systems under multitasking systems at the time. With discless UNIX system operation possible and the large number of application software now available, conversion of the PASCAL-based system to a total UNIX system network actively is being considered.

The network presently uses a combination of various impact printers, pen plotters and microfilm aperture card document copiers for reproducing documents. New high-performance Imagen 5320/7320 printers are being evaluated to replace most of the existing reproduction equipment. Distributed laser printers over the network can provide for the distribution of engineering documentation from online storage of document files. Centralized high-volume printers can be used to provide for on-demand printing of customer documentation, further increasing the quality and product delivery throughput for Rockwell's customers. —David A. Lindberg is a systems engineer for the Network Transmission Systems Division at Rockwell International Corporation, Dallas, TX.

Would you like to continue to see articles on this topic?
Circle on reader card
yes 334 no 333

Use Type Director To Make Documents More Professional. Send In This Form Today.

- I need Type Director™ to produce professional-looking documents. Rush me the items indicated.
 Please send more information.

QTY	ITEM	PRICE*
	Type Director Debut Edition, MS/DOS (Includes 12 Typefaces: Volumes 1,2,3)	\$225
	Type Director Debut Edition, OS/2 (Includes 12 Typefaces: Volumes 1,2,3)	\$225
	Type Director Font Management Program (Includes 2 Typefaces: CGTimes, Univers Bold)	\$95
	Vol. 1: CGTimes†	\$195
	Vol. 2: Univers†	\$195
	Vol. 3: Decorative† (See ad)	\$195
	Vol. 4: CGTriumvirate†	\$195
	Vol. 5: Univers Condensed†	\$195
	Vol. 6: Futura II†	\$195
	Vol. 7: Microstyle†	\$195
	Vol. 8: Decorative† (ITC Zapf Dingbats 100,200,300)	\$195
	Vol. 9: CG Century Schoolbook†	\$195
	Vol. 10: ITC Benguiat†	\$195
	Vol. 11: ITC Lubalin Graph†	\$195
	Vol. 12: ITC Avant Garde Gothic†	\$195
	Vol. 13: ITC Souvenir†	\$195
	Vol. 14: Garamond Antiqua†	\$195
Subtotal		
Applicable state and local sales tax		
Shipping/handling(\$5 per item)		
Total order		

Name _____

Company _____

Address _____
(No P.O. boxes please)

City _____

State _____ Zip _____ Country _____

Phone () _____ Ext. _____

Every effort will be made to ship your order within 24 hours. All shipments are via Federal Express; please indicate street address since Federal Express can not deliver to a post office box.

- Check or money order enclosed payable to: AGFA CompuGraphic. MasterCard Visa

Account No. _____

Exp. _____ Today's Date _____

Signature _____

Order Hotline 1-800-873-FONT

AGFA 

AGFA COMPUGRAPHIC DIVISION

90 Industrial Way, MS90-1-3C

Wilmington, MA 01887-9945

(508) 658-5600 Ext. 2484/2485

*Prices stated in U.S. dollars and subject to change without notice.

†All products come with MS-DOS & OS/2 compatible diskettes unless otherwise noted. Each volume contains 4 typefaces from the family listed unless otherwise noted.

CIRCLE 177 ON READER CARD



from the lab

The HCT Terminal By Cumulus

By Sheldon Green Cumulus Technology Corporation (Palo Alto, CA) provides a terminal that exceeds many of the functional features found in the standard HP block mode terminal at a lower price.

At first glance, the battleship grey HCT terminal doesn't appear to be anything more than another inexpensive dumb terminal, however, the HCT's function-rich features make this terminal more than worthy of consideration.

The terminal's first striking feature is its 15-inch diagonal flat screen profile with a character font that's composed of a set of large, easy-to-read, fully-formed letters, numbers and special characters. It should be noted that the clarity and size of the display is outstanding. The screen is larger than HP's 14-inch diagonal screen found within the HP 700/9x Series terminals. Each of the character cells is composed of a 13 x 16 pixel matrix compared to the 9 x 14 pixel matrix used by HP. This becomes an 8 x 16 pixel matrix verses HP's 6 x 14 matrix when in 132 column mode. Here, the higher-resolution character formation really sets the HCT terminal apart.

The second major feature supplied with the terminal is a set of desktop accessories. The accessories include a



The large, flat screen is the most outstanding feature of the terminal.

personal file, calendar, notepad and a calculator. There also is a built-in help function to further support the use of the desktop accessories.

The third noted feature of the terminal is the warranty, repair and exchange policy provided by Cumulus. This policy includes warranty service coverage for a full five years from date of purchase, including the repair or replacement of any HCT terminal that requires service.

Compatibility & Documentation

The setup of the HCT terminal is a very straightforward process, as clearly outlined in the *User's Quick Reference Guide* and on top of the shipping carton. All you have to do is plug in the power cord, plug your datacomm cable into the respective RS-232 or RS-422 port provided using an EIA standard 25-pin 'D' connector located on the rear of the terminal, and turn the power switch on.

The guide consists of approximately 40 pages and is well organized and concise. It includes the following sections: (1) Introduction, (2) Installation & Setup, (3) Using Your Cumulus HCT, (4) Desktop Accessories and Help, (5) If Something Goes Wrong, and lastly (6) Cumulus and Hewlett-Packard.

The HCT terminal appears to parallel the HP terminal products as an exact clone. It should be noted that the terminal performs well with all of our applications.

Help

The on-line help consists of two pages of text that can be displayed and read. It includes a set of help instructions for both the desktop accessories.

Screen

The large, flat white monochrome screen monitor is the most outstanding feature of the HCT terminal. The

MUST Reading Computing Books From Professional Press

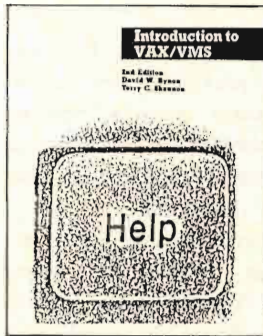

Introduction to VAX/VMS, Second Edition

Introduction to VAX/VMS is a guide for beginners and a reference for the experienced user. From the basics to systems and programming, Introduction to VAX/VMS gives easy to follow instructions about the VAX computer family, DCL command language, command procedures, mail, backup and help features and more. Through pictures, examples and programs, you get explicit instructions for everyday use of VAX/VMS and tips for problems. Plus 8 Appendices and a Glossary for added reference.

Order Introduction to VAX/VMS now. Complete the form below or call Trish at (215) 542-7008 (9-5 eastern time) with credit card information.



Let's C Now

Let's C Now is a self teaching guide to the C language in two volumes. It has all the information you need to learn C language, from the basics to expert use and understanding. Twenty-six informative chapters with tested examples, author's tips and suggestions make it easy to learn, even if you're not a computing expert. Use "C" on any operating system with DEC hardware (primarily for VAX and PDP).

Order one or both volumes of Let's C Now on the order form below, or call Trish at (215) 542-7008 (9-5 eastern time).

**Complete and mail the form below
with payment to order
1, 2 or all 3 of these
important computer handbooks
NOW!**

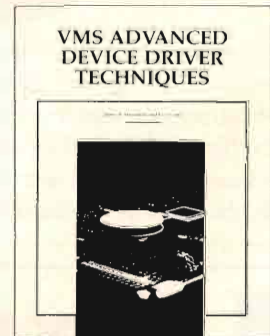

NEW . . . VMS Advanced Device Driver Techniques

By Experts Lee Leahy of Digital Equipment Corporation and Jamie Hanrahan of Simpect Associates VMS Advanced Device Driver Techniques describes how to design, implement and debug device drivers for the VMS Version 5 operating system. Learn more about simple VMS device drivers, full duplex and state machine-based drivers, VAX BI Drivers, advanced strategies and techniques you can use for debugging VMS device drivers and much more. From the low-level "building blocks" to high-level design issues, it's everything you need to become a proficient user of VMS device drivers.

Order now. Fill out the order form below or call Trish at (215) 542-7008 (9-5 eastern time).

YES! I want to complete my computing library with one or more of these important computing handbooks from Professional Press!

Name of Book	Number of copies	Shipping/Handling (per book)	Total \$
VMS Advanced Device Driver Techniques at \$59.95 each		US \$3.00, Canada \$5.00	
Introduction to VAX/VMS Second Edition at \$29.95 each		US \$2.00, Canada \$4.00	
Let's C Now Volume 1 at \$22.95 each		US \$2.00, Canada \$4.00	
Volume 2 at \$22.95 each		US \$2.00, Canada \$4.00	
Volumes 1 and 2 at \$42.95 per set		US \$2.00, Canada \$4.00	
Total Number of Books			Total \$

Check/Money Order enclosed Please charge: VISA MasterCard

Account Number _____ Exp. Date ____ / ____ Signature _____ Date _____

Name _____

Address _____

City _____ State _____ ZIP _____ Telephone () _____

Call me with multiple copy discounts

Mail or FAX this form to: Professional Press, Inc., P.O. Box 503, Spring House, PA 19477 (215)542-7008 ■ FAX (215)628-2845



characters are large and clear. For those people who prefer green or amber monochrome screens, they are available.

Both the power on/off switch and the brightness/contrast controls are located at the front of the terminal for

easy access. The brightness/contrast control, however, seems to have a relatively narrow range providing little variability of contrast or brightness. These physical functions could have been engineered with a more conven-

tional design approach. Two separate dials would provide greater control over these functions instead of providing a single, combined dial (it's actually a lever) to control both the brightness and contrast of the monitor.

The terminal is equipped with a sleep mode function for automatic power-off after a 15-minute timeout interval. This feature is an enhancement over the HP screen saver function. It not only preserves the screen phosphors, but it conserves the power consumed as well by shutting off the internal electronics. This feature makes good sense and probably should be considered by HP for incorporation within their terminal product lines in the future.

The monitor itself is ergonomically designed with the basic tilt-and-swivel capability that is expected of any state-of-the-art terminal today.

Keyboard

The keyboard conveniently plugs into the front of the terminal at the base using an RJ11 connector. But, with the exception of the additional function keys to support the desktop accessories, the keyboard follows the general layout of HP's 239x Series terminals. This is an older layout that has been enhanced by HP in its current line of 700/9x Series terminals. The newer, enhanced keyboard delineates the functional key groups better by spacing them apart. With the newer key-presentation layout, the keyboard is much less overwhelming and easier to navigate.

The terminal does provide an 80/132 HotKey toggle, a really nice feature that is not available on HP's terminals. It's necessary to enter several keystrokes within HP's configuration keys to toggle between 80 and 132 column mode.

Desktop Accessories

The desktop accessories provide an additional set of functions that are not found normally on a standard, conven-

Why not the best?



**HP 1000,
HP 3000, &
HP 9000
150 Megabyte
& 2 Gigabyte
Streaming Tapes**
Unattended backup
of all your data on a
single ultra-compact
cartridge.
Media translation &
SSS update service
available

Also available:

HP 1000 Memory Expansion

Improves system performance. Free evaluation.
512 KB to 32 MB expandable cards. 2 year warranty

High Performance SCSI Interfaces for HP 1000, HP 3000, & HP 9000

Superior to IEEE-488. Used with all Herstal
Automation peripherals

HP 1000 & HP 9000 Disc Drives

65 MB to 638 MB. 30,000 hour MTBF.
Up to 7 drives per interface

HP 1000 & HP 9000 Optical Discs

1 Gigabyte Erasable and "Write Once". Ideal for
information retrieval and archival data storage

Ramdisc/1000 Speeds up file access

Superclock/1000 Automatic time & date



*"I promise you —
no service hassles, no
matter who is servicing
your HP system."*

Rick Walsh
President



HERSTAL

AUTOMATION LTD.

3171 West Twelve Mile Road
Berkley, Michigan, USA 48072
Telex 650-321-1560
FAX 313-548-2010
Phone 313-548-2001

HCT Terminal

Platforms/System Requirements: HP 1000, 3000 classic, 3000 Spectrum, 9000, MPE, RTE, HP-UX, ATP/DTC, RS232/RS422.

Price: \$795

CUMULUS TECHNOLOGY CORPORATION

Headquarters:

1007 Elwell Ct.
Palo Alto, CA 94303
(800) 648-6004 or (415) 960-1200.

Founded: 1985

Product Line: HP compatible terminals

Ownership: Public

CIRCLE 268 ON READER CARD

tional terminal. These functions are similar to the pop-up terminate- and stay-resident (TSR) functions found in the PC world. These added utilities include a personal file system, a notepad, a calculator and a calendar.

The calculator and calendar accessories are by far the most practical and useful of the desktop accessories provided. The calculator is a standard four-function business calculator with memory. As with all the desktop accessories, the calculator has a transfer function that allows highlighted information to be copied from an accessory to an internal terminal buffer and then to an attached computer. As mentioned earlier there also is a built in help function to further support and document the use of these desktop accessories.

The calendar accessory provides a set of calendars that offers a set of daily "to-do" list templates. Each "to-do" list template enables the association of an activity with a daily time at half hour intervals. A real-time clock is built into the HCT terminal to provide an alarm function. This capability can be used with the lists to set various alarms to

announce the scheduled start of any defined activities.

The personal file system is a mini database that can be used to capture names and addresses through a predefined address template screen. This screen includes a name, address, phone number and a corresponding comment.

And lastly, there is a notepad function that allows you to type in a note as a reminder, etc.

Service, Repairs And Warranty

A major attraction to purchase the HCT Terminal is the extensive warranty policy established by Cumulus Technology. The policy includes a five-year warranty period that is four years beyond the one-year warranty period provided by Hewlett-Packard.

The first year of the warranty provides for a "next business day exchange program," whereby the customer will be shipped (freight prepaid) an HCT terminal for delivery on the next business day after notification. In addition, the terminal needing repair will be picked up via UPS within three days at the expense of Cumulus Technology.

In the second through fifth years of the warranty period, the terminal may be returned for repair with a guaranteed five-day turnaround. The terminal would be repaired or replaced at the option of the Cumulus Technology Corporation. Clearly, Cumulus believes in the quality of its HCT terminal and has made a total commitment to support its product.

The overall combination of attractive pricing, extensive functions, functional transparency within the HP environment and an extensive warranty policy, make the HCT terminal by Cumulus Technology a good choice.

Would you like to continue to see articles on this topic
Circle on reader card
yes 342 no 341

IEEE-488...



Converters and Controllers for RS-232, RS-422, Parallel, and SCSI

- Built-in 64K byte or 256K byte RAM buffer to spool data
- Controllers have onboard, programmable operating systems for standalone applications
- Switch selectable interface parameters
- Built-in DMA controller supports high speed transfers on the GPIB port (up to 900K bytes/sec)
- All-metal MicroGPIB™ case and connectors form a high impact shielded enclosure that minimizes EMI

Data Buffer

- 900K bytes/sec transfer rates
- 1M bytes of RAM

Extenders/Expander

- High performance parallel bus extender
 - Supports 28 devices at 300 m
 - 222K bytes/sec transfer rates
- Serial bus extender
 - Fiber optic or coaxial cabling
 - 144K bytes/sec transfer rates
- Bus expander
 - Optically isolates 2 GPIB buses
 - Extends GPIB by interfacing up to 14 more devices
 - Doubles the GPIB 20 m cable limit
 - Transparent to user software

- *FREE Customer support*
- *30-day money back guarantee*
- *2 year warranty*

NATIONAL INSTRUMENTS®
The Software is the Instrument™

12109 Technology Blvd.
Austin, Texas 78727-6204
(512) 250-9119
(800) 531-4742 U.S.
(800) IEEE-488 in Texas

Japan 81 (03) 788-1921 • France (1) 48 65 33 70
United Kingdom 44-01-549-3444 • West Germany 49 89 807 081
Italy 39-2-98491071-2-3 • The Netherlands 31 070-996360

Call for FREE catalog

CIRCLE 149 ON READER CARD



RDBMS

Fabian Pascal

Last month we examined the benefits of representing data as tables. One major advantage is the ability to perform operations on whole tables,

which are mathematical, and thus systematic, precise, reliable, complete and nonprocedural. Let's look at the "arithmetics" available for R-Tables.

I intentionally avoid concrete examples to give you a simple, conceptual introduction. Specific data examples will be provided when the SQL "concretization" of these operations is discussed.

The Basic Operators

The generic format of table operations is shown in *Figure 1*. First, we must be able to take results obtained from an operation on tables and assign them to a result table. Thus, we need an ASSIGNMENT operator, which is represented by := in *Figure 1*.

There are five basic table operations. The first one is picking certain rows from a table (three in *Figure 2*). This operation is called RESTRICTION (or RESTRICT), for "restricting" the tables on certain rows. SELECTION (or SELECT) is another name for this operation. I am using restriction to avoid confusion with the SQL command SELECT, which supports not just restriction, but all the operations discussed here.

Next, there is an obvious counterpart to restriction, illustrated in *Figure 3*. Called PROJECTION (or PROJECT), it does to columns what restriction does to rows. The result is a projection of the table on the selected columns.

The third operation is described in *Figure 4*. It concatenates every row of one table to each row of another, yielding a result that combines the columns of both tables, and has as many rows as the product of the number of rows in each (in this case, $3 \times 2 = 6$), and as many columns as both tables combined ($3 + 4 = 7$). This operation is called PRODUCT.

The fourth basic operation, UNION, is shown in *Figure 5*. It unifies rows with the same number of columns from two tables into one table.

Figure 6 shows the last basic operation, DIFFERENCE. It "subtracts" from one table those rows that do not exist in another table (i.e., it takes from it only the part that is not common to both tables), hence its name.

Note that some of the names of these operations resemble those of arithmetic operations (product, difference, divi-

sion). But similarly named operations on tables and numbers are not the same thing.

Because these operations originate with relations, which are mathematical sets, one of their properties is the ability to be combined in any sequence, similar to that of arithmetic operations on numbers. Thus, we can have combinations such as:

```
((RESTRICT a) PRODUCT (PROJECT b)
  UNION (RESTRICT (PROJECT c)))
```

where a, b and c are R-Tables. The manipulative power of such combination should be obvious. It is particularly important in databases, where users don't always know in advance which data they will end up with, and need to continue to operate on results until they get what they want. As we shall see, "arbitrary nesting" of operations also is critical for optimization — the method by which relational DBMSs support physical data independence.

We say R-Tables are "closed" to these operations, like numbers are to arithmetic operators. CLOSURE is critical, because anything other than R-Tables loses these mathematical

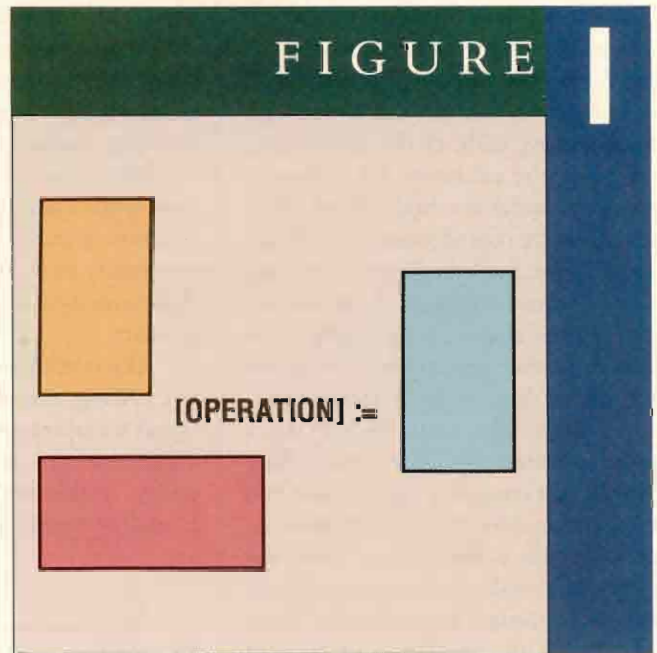

The generic format of table operations.

FIGURE 2-6



Figure 2.

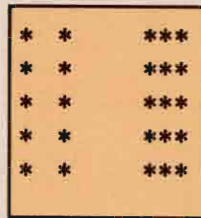

Figure 3.

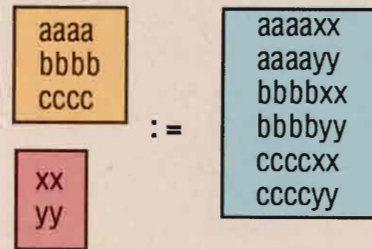

Figure 4.

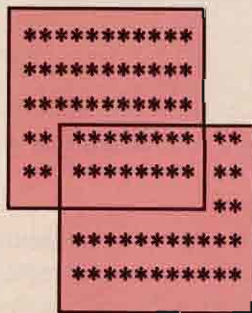

Figure 5.

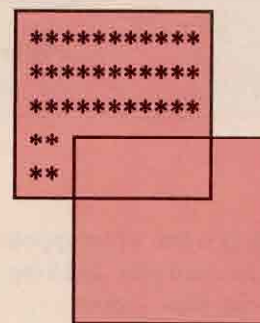

Figure 6.

Five basic table operations.

properties, restricting the user. Think of the possible consequences if arithmetic operations didn't always yield arithmetic results.

Some Convenient Combinations

With these five table operators, single or in combination, all theoretically possible table manipulations can be expressed. We are dealing here, however, with theory that must have practical applicability. It turns out that there are several combinations of these operators that are likely to be used frequently in practice. Instead of leaving users to combine them again and again, Dr. E.F. Codd (former IBM research fellow) simplified matters by requiring their direct support for convenience.

An important and relatively better known combination is:

```
(PROJECT(RESTRICT(a PRODUCT b)))
```

known to users as JOIN. The most common type of join is illustrated in Figure 7.

Like product, joins concatenate rows from tables. But while product does it indiscriminately for all rows in both tables, joins are more selective. They do it only for those rows

in one table that fulfill certain conditions, usually relative to the rows in another table. The figure presents the NATURAL JOIN, where the restricting condition is "matching values in columns shared by both tables" (in this case, the second column in the first table and the first column in the second table).

Thus, while seldom used directly, product is the basic operator required for support of combinations such as joins, which are more practical. The DBMS uses it in the background to execute such combinations.

There are several types of joins. The natural join is a special case of the more general situation in which the join condition is not just equality (or matching), but can be any conditional operator, such as >, <, > <, etc. There also are OUTER JOINS that include some rows not fulfilling the join condition in the result. They are postponed to simplify matters.

Another convenient combination (Figure 8) is the INTERSECTION (or INTERSECT). Basically, it selects the rows of a table that is shared with another table. Compare it with UNION and DIFFERENCE and see if you detect any relationship that suggests how this operation can be derived from them.

Finally, there is an operation called DIVISION. The most

FIGURE 7-9

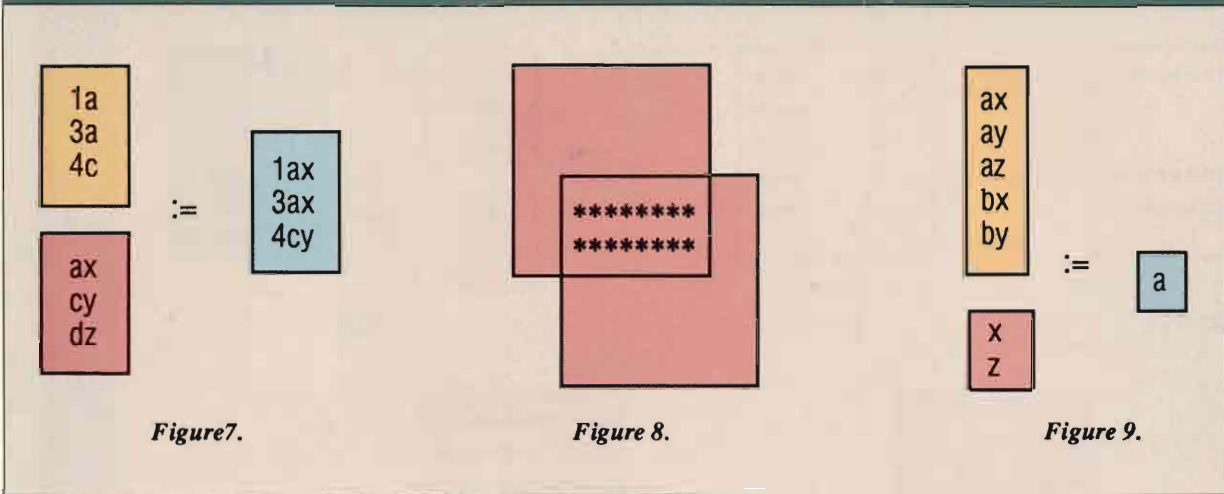

Examples of a join, intersection and division respectively.

simple division is shown in Figure 9. It is sort of an opposite of the concatenations done by product and join, and I leave it as an exercise for you to figure out what it does.

Some other operations are needed because of missing or inapplicable data in computerized tables, and for some other reasons. These also are postponed for simplicity.

Practical Implications

A critical point to be made about table operators is that while they have a theoretical basis, each one of them answers very real question that users need to apply to databases in practice. This is, again, similar to numeric operations where certain theoretical formulae can be used to describe physical or other real phenomena. Let's go back to the school database example that I used in my first article (see January 1989):

STUDENTS (S#, SNAME,...) — student data
 TEACHERS (T#, TNAME,...) — teacher data
 CLASSES (C#, TITLE, TIME,...) — class data
 ATTENDS (S#,C#,...) — student class assignment data
 TEACHES (T#,C#,...) — teacher class assignment data

The query, "What are the classes and teachers of student George Walters?" easily can be expressed (as we shall see when we go into SQL, in one statement) as a five-table join that exploits the columns common to the tables C#,S#,T#. Similarly, in a suppliers-parts database, the relational division operator underlies the query, "Which suppliers supply all the parts?"

If a DBMS doesn't support the join or division operators,

a program needs to be written to simulate them, usually record by record, as in the dBASE example described in January's column. To appreciate the utility of the operators, readers with a programming background should try to express the above queries in their favorite programming language.

Second, the table operators are a complete set (although additional practical combinations can be used for convenience). What does it mean to have DBMS support of only some of the operations, such as restriction, projection and join, for example? (Note: Restriction, projection and join were Codd's minimal requirement initially because he wanted to give nonrelational vendors some time to comply gradually. He has long since rescinded it and now, after 20 years, requires support of all operations.) It really means that whenever an operation underlying a user query is unsupported, someone will have to PROGRAM the equivalent. Even when a DBMS offers menu-, prompt- and icon-driven interfaces to databases, these table functions must be supported underneath, in order for those facilities to effect user data requests specified through such mechanisms.

The next time someone claims that relational databases are just theory, and thus difficult and without practical utility, ask the person what is the alternative to the relational set of table operations which is easier, more practical, and offer complete functionality? —Fabian Pascal is a Washington DC-based analyst, consultant and author specializing in relational database management and SQL on the PC, and is affiliated with Codd & Date International.

Would you like to continue to see articles on this topic?
 Circle on reader card
 yes 350 no 349

East of the sun. West of the moon. Windjammer.



A place to live your fantasies.
A place to free your soul.

To cozy up to the Caribbean sun.
To dance among a thousand stars
to the rhythms of steel drums.
To play on sparkling white and
pink sand beaches.
To discover the underwater
paradise of the reefs.
To find a new friend and share the
intimacies of a sensuous night.

To come alive and live.
To remember for a lifetime.

6 days and 6 nights. From **\$625.**

Reservations toll free
1-800-327-2600
In Florida 1-800-432-3364

**Windjammer
Barefoot Cruises**

Post Office Box 120.
Miami Beach, Florida 33119.



CIRCLE 176 ON READER CARD



"Cap'n Mike, rush me my free full color 'Great Adventure' booklet and show
me the way to Paradise for 6 days and 6 nights from \$625."
Windjammer Barefoot Cruises.
P.O. Box 120, Dept. 4288 Miami Beach, Fla. 33119.

Name _____
Address _____
City _____
State/Zip _____



STORAGE

Don Person

Curing LIF Hard Disc Indigestion

You've been using your nifty, reliable HP hard disc with a Series 200, 300/80 or whatever. Every Friday you run a program that drives test equipment for quality control and then place the results in a pair of small files that use only 10 KB each.

This goes on for a little over a year until one day, without warning, you see the dreaded NO MORE FILESPACE error. You can't store in memory the data you're sitting on. It's puzzling because your last disc check showed that only about two MBs of that spacious 20-MB drive are occupied. What has gone wrong? Simple: You've met the "Directory Full" demon.

As disc operating systems have evolved over time, it has become all too easy to forget about the land mines that often lie buried inside. The benefits of linked-expandable file directories need no further endorsement from me, but in the HP computing world, most of us are unaware of the potential for user heartburn implied by the organization of HP-LIF media.

Happily, the problem described here almost never crops up with floppy discs. Yet, when it does, the stage it inevitably chooses is a fairly well-loaded hard disc.

A major feature of newer disc organizational schemes such as MS-DOS is the automatic ability to stretch the directory capacity factor of your disc as needed. This is done quite simply through a linked list that is inherent in cluster-by-cluster allocation and, in fact, also mirrors the way files are created and grow.

This property unfortunately is not

shared by popular older systems such as HP-LIF or CP/M. In an MS-DOS system, a certain amount of disc directory space is set aside for the root directory when the disc is high-level formatted and whenever a new subdirectory is created.

The default value for the root is 112 files, while the starting size for a subdirectory is found by dividing the number of bytes in a cluster by 32. Ordinarily, this starting value will be 30 or 62 files.

If you rummage around the

FIGURE

LIF directory organization :

ii = System ID - This value is assigned to the producing division at HP, and is a signed integer word.

VVVVVV = 6 character volume label

BBBB = double word unsigned integer Base sector number of the directory block

EEEE = extent of the directory block ie how many sectors are allocated for the directory.

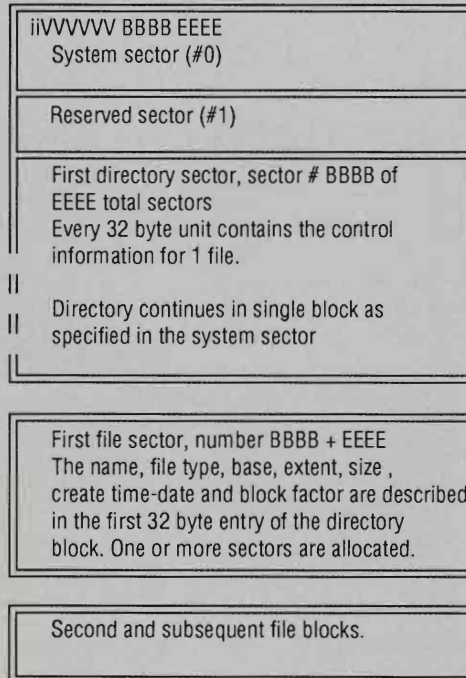

LIF directory organization

MS-DOS programmers guide, you'll notice that each "subdir" reserves two entries when you set it up: one for forward and one for reverse linkage. This enables traversal for the system and permits expansion if needed.

The Problem With LIF

Now for the problem with LIF. It freezes the size of the directory at the time a disc is formatted. This count remains static forever. No provision is made to increase or decrease its size. The terror of all this is that, in normal use, you never run into the limit until you've hit the magic number of 112 files. The genesis of this value is common to all the LIF systems I know of (14 directory sectors with eight file headers each for a total of 112 entries per disc).

By some coincidence, 14 directory sectors plus two system sectors equals 16. For the curious, this is the count of

sectors per surface on the original 5¼-inch Amigo drive. It happens to occupy side zero of track zero. Carrying this value forward into larger disc systems is no complement to HP's performance with respect to software design review.

To give some credit to Mom's DOS designers, I must point out that it is possible to increase or reduce this number at format time, but so few people are aware of the potential heartache that, in my experience, it rarely happens. That's the last time most of us ever think about directory size until finding out that the choice we didn't make just crash-landed in our lap.

THE CURE FOR ALL THIS is as frustrating as it is arduous. First, you have to get enough flexible media (read floppy discs) and then copy all your hard disc files off until they're safely backed up.

Without wildcard naming, you'll probably have to camp out while you type in the name and COPY command for each of those 112 entries you have.

Next, completely reformat the hard disc, only this time give it all the directory space you ever think you'll need and then some. By now you're willing, if not a bit anxious, even to go overboard a little — anything to avoid living this nightmare twice. Then you sit back and take the rest of the day copying all your files back onto the disc again. Finally, you're back where you started with room to grow once more.

All of this could've been avoided by carefully estimating the size you needed way back when. But that's life as it should be, not as it is. While this process can be done, it's not easy or fun.

This has happened to a few of my clients and, after the most recent round of this madness — comprised of two



Westinghouse Idaho Nuclear Company, Inc.

HP 3000 PROGRAMMER ANALYST

We are seeking a candidate with a BS Degree in Information Systems or Computer Science and three - five years HP 3000 experience using COBOL, IMAGE and VIEW. Transact and some IBM JCL knowledge helpful.

The successful candidate will be responsible for analysis, design, programming and documentation for new and existing business applications.

All applicants must have, or qualify for, a DOE "L" security clearance.

For immediate consideration please send resume with copy of advertisement to: Ace Ballard

Westinghouse Idaho
Nuclear Company, Inc.
P.O. Box 4000
Idaho Falls, Idaho 83403

Equal Opportunity Employer
U.S. Citizenship Required.

KEEP UP IN A CHANGING WORLD

Take advantage of the wealth of knowledge available from your Government. The U.S. Government Printing Office has just produced a new catalog. It tells about the most popular books sold by the Government — nearly 1,000 in all. Books on agriculture, business, children, diet, energy, health, history, space, and much, much more. For a free copy of this new catalog, write —

New Catalog

Post Office Box 37000
Washington, D.C. 20013

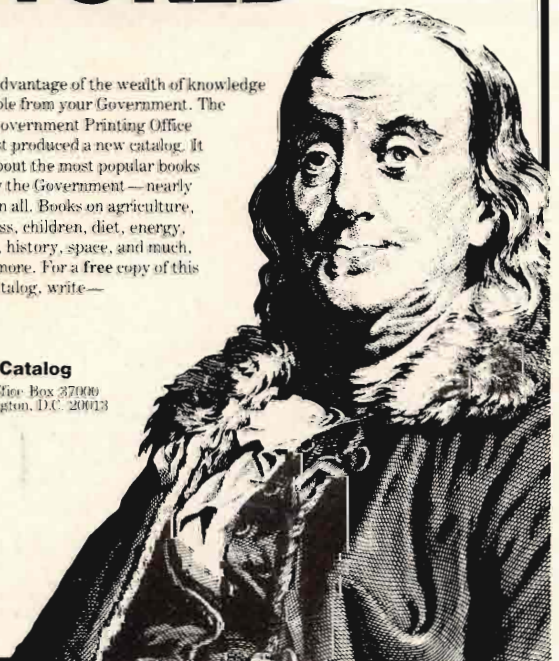

events in the same week — I thought I might do something about it. There is a way to cheat LIF's architects and stretch that directory no matter how

word integer stored right after the ID word and six bytes of volume ID.

Every LIF disc must start with system information. No exceptions.

Strictly speaking, the only practical value is in protecting areas of the disc from overwriting by ordinary files.

small you made it to begin with. Read on and I'll present a very short solution that fixes this shortcoming. To really see the solution, you first should understand how this problem came about.

IN THE PAST, I've devoted some effort to explaining the structure of individual LIF directory entries, but never tied it into the greater logical organization of the disc as a complete entity. *Figure 1* shows the basics. The first data of importance to us is the base sector double-

This has the pointers to the actual directory block without which files aren't identified. Ordinarily, the first directory sector is number two, but I must stress that this isn't cast in stone. Rather, it is a matter of both safety and practicality to follow HP's lead. While we could begin the directory anywhere on the disc surface, this forces us to spare all the tracks between its start and the system sector and offers as a consequence no ability to reclaim space below this address that already is in use.

Strictly speaking, the only practical value is in protecting areas of the disc from overwriting by ordinary files. I took advantage of this property years ago when I wrote Smart Backup as a way of guarding against accidental overwrites when storing hard disc images on floppies.

Rounding out the content of the system sector is the second double-word integer conveying the number of sectors to be found in the directory block. Again, by default, this value is 14. This is the quantity that controls how big a directory is assumed to be.

The sector following the system entry is by custom spared, although, over the years, it has been used in application-specific ways, most notably for rather primitive forms of copy protection.

Full Directory Solution

To cure the full directory problem, we need to stretch the directory to make more room and then logically initialize the new portion. Once again, this is easier said than done, because from

A

Program .

```

1000 ! *****
1100 ! *
1200 ! * Expand an existing LIF directory block without a re-format
1300 ! * Uses PHYREC,PHYREC-80, LIF or other read/write physical sector
1400 ! * Binary programs
1500 ! *
1600 ! * D.E.Person 8-24-88 Released to the public domain
1700 ! * For personal use ONLY
1800 ! *****
1900 DIM A$(4096),WORK$(256)
2000 CLEAR
2100 DISP "This program will expand the size of your LIF disk directory"
2200 DISP "What disk MSUS to stretch ( in the form ':Dnnn' ) ";
2300 LINPUT MSREFS
2400 DISP "Please wait while examining the disk"
2500 SIZIT: RSECTOR WORK$,0,MSREFS ! load the system sector from target disk
2600 DIRBAS=INUM2 (WORK$(11,12)) ! determine the start sector of cur dir
2700 DIREXT=INUM2 (WORK$(19,20)) ! how many sectors allocated to it ?
2800 RSECTOR A$,DIRBAS,MSREFS ! read in the first directory block
2900 FOR UPT=1 TO LEN (A$) STEP 32 ! find null file with an extent
3000 IF INUM2 (A$(DPT+10))#0 THEN NREDY ! no nulls found
3100 IF INUM2 (A$(DPT+14))#0 THEN HAVIT ! found a candidate
3200 NEXT DPT
3300 ! no free space, so fail
3400 NREDY: DISP "DISK NOT PREPARED WITH NULL FILE FOR STRETCH" @ GOTO GOWAY
3500 HAVIT: SEXT=INUM2 (A$(DPT+18)) ! extent of stretch file
3600 SBAS,NBAS=INUM2 (A$(DPT+14)) ! The Base of the stretch file
3700 DISP "The directory at present fills ";DIREXT;" SECTORS"
3800 DISP "and allows up to ";8*DIREXT;" file entries"
3900 DISP "The null file we can stretch fills ";SEXT;" SECTORS"
4000 DISP "This would allow up to ";8*SEXT;" MORE file entries"
4100 DISP
4200 DISP "HOW MANY OF THESE SECTORS (0-";SEXT;" ) SHALL WE CLAIM ";
4300 INPUT DIRCOUNT
4400 IF DIRCOUNT=0 THEN GOWAY ELSE DIRCOUNT=MIN (DIRCOUNT,SEXT)
4500 IF DIRCOUNT=SEXT THEN SBAS=-1*DIRCOUNT
4600 DISP "Please wait.... Adjusting directory"
4700 A$(DPT,DPT+31)=RPT$(CHR$(0),32) ! null out whole file entry
4800 A$(DPT+14,DPT+15)=ICH2$(NBAS+DIRCOUNT) ! the new place for start
4900 A$(DPT+18,DPT+19)=ICH2$(SEXT-DIRCOUNT) ! set the new EXTENT
5000 WSECTOR A$,DIRBAS,MSREFS ! rewrite directory head
5100 WORK$(19,20)=ICH2$(DIREXT+DIRCOUNT) ! ADD NEW EXTENT
5200 WSECTOR WORK$,0,MSREFS ! rewrite the system sector
5300 now initialize the new directory sectors
5400 !
5500 WORKS=RPT$(RPTS (CHR$(0),10)&RPTS (CHR$(255),2)&RPTS (CHR$(0),6)
&CHR$(255)&CHR$(127)&RPTS (CHR$(0),12),8) ! empty dir pattern
5600 FOR J=NBAS TO NBAS+DIRCOUNT-1 ! write it to each new dir sector
5700 WSECTOR WORK$,J,MSREFS
5800 NEXT J
5900 DISP "Remember to copy/restore the file you purged !"
6000 GOWAY: DISP "The directory expander is done"
6100 BEEP @ END

```

Figure 1 you can see that the first file we create occupies the first sector following the directory. Because there is no linking mechanism, all directory blocks must be adjacent. Moving and expanding the directory block at the end of the medium has the disadvantages I just mentioned plus the added unreliability of putting a vital area of control information onto what is physically the most densely packed data area of the disc. The only sensible thing to do is to make the directory bigger on the fly.

Here's the answer: If we make the first file entry on the disc go away, we can take over its space, add it to the directory block that precedes it and change the system header to reflect the new status. Fortunately, there are several easy ways to do that. We can copy the file off the hard disc, purge it, do the stretch and then copy it back so that it appears at the end. Or, more simply, we could copy it under another name if the directory is not already chock full, purge as before and rename the temporary copy to complete the stretch.

Two more minor choices may be in order. If the first file is much larger than we need, we could waste vast amounts of disc-free area or, if it's too small, not enough new space might be freed. In the second instance, you still could repeat the process — COPY, PURGE STRETCH, RE-COPY — until you reclaim the space you need.

If the first case applies, you could restore the entry you've claimed. But, with a higher base and smaller extent using just the portion of the file, you need to expand the directory block's territory. If the file had 1,000 sectors, you might only want to take away 50. After the manipulation, there still would be a null file showing with 950 sectors free.

This avoids excessive losses that could never be usefully put back into storage service. Each "stretch" leaves a null file that has a base and extent of zero. While these entries can be removed later by a PACK, in practice they do no harm because they otherwise won't be accessed for a fresh create attempt.

Keeping just 32 bytes out of service is a small price to pay for freeing up MBs in return.

One special software option is needed to do this. You must have a copy of the physical record utility for the computer system you use, variously called PHYREC, LIFBIN and several

other names. This provides the physical sector read/write capability that this particular magic was conjured from. — *Don Person is an independent consultant based in Albany, NY.*

Would you like to continue to see articles on this topic?
Circle on reader card
yes 336 no 335

Art or Industrialization?

Sometimes you have to make a choice

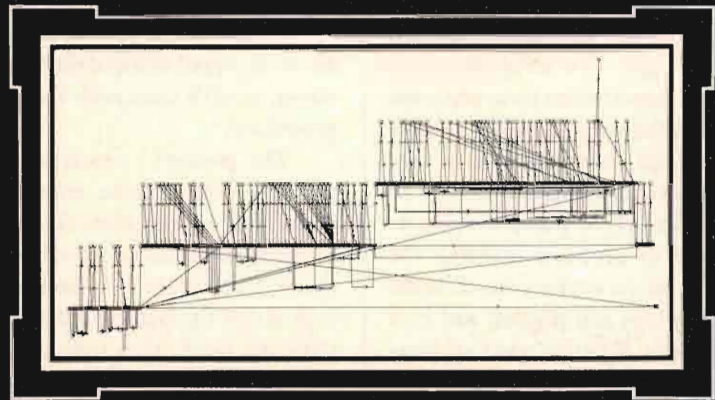

A control flow graph from **LOGISCOPE**

If this were the *artwork* of a deceased artist, it would likely be shown at the National Gallery of Art.

If this is the *control flow (logical structure)* of one of your programs, don't wait the departure of its author to recognize the merit.

LOGISCOPE, a Source Code Analyzer from VERILOG, automatically *visualizes* the structure of programs written in over 30 different languages: *Ada, C, Cobol, Fortran...* and supports *Apollo, HP9000, IBM (vm,mvs), SUN, VAX (vms)*.

**Call 800-347-0371 or 703-354-0371
for more information.**



VERILOG USA
6303 Little River Turnpike
Alexandria, VA 22312

CIRCLE 187 ON READER CARD



PCTIPS

Miles B. Kehoe

Capture Special Keys

When you're writing applications that will be used by people who are not familiar with computers, you always should take extra precautions to insure the keyboard works the way a novice would expect, not the way you've grown accustomed to over the years. I've always believed it's better to spend extra time and code space in development in order to save every user the frustration of a user interface that "just misses."

One area where many developers fall short is in properly utilizing the special keys on the keyboard such as the [Home], [PgUp] and [PgDn] and cursor arrow keys. Whether your application is using HP Vectra PCs or IBM PCs, it's not difficult to trap these keystrokes and use them in your application. The *Program* shows you how to capture these special keys.

Keys On The Vectra

The Vectra, like most other IBM-compatible systems, allows you to capture one key at a time from the keyboard using the built-in ROM BIOS calls. The function I use here to capture keyboard input is BIOS function 16 (hex), which accepts one of three modes in the AH register and returns the ASCII value for the key pressed and the scan code, or a zero byte and the special key value.

Because I want my program to be as simple as possible, I would rather have my input routine process the raw data returned by the BIOS call and return to me a single character rather than have to handle the possible combinations in line in my code. There are a number of ASCII codes that I don't an-

ticipate as possible input, so I have defined a routine that will make the BIOS call, return the normal ASCII code if the key is a normal key, and return a coded byte above the normal ASCII range if the key is a special key.

The Vectra code is shown in the *Program*.

I have made some assumptions about the types of input the user will be doing, so let's start with the **getkey()** procedure.

The **getkey()** procedure assumes that the user will be entering ASCII codes and special keys. Specifically, I assume that no keyboard entries will be above ASCII code 159. Because this is well above the highest ASCII character normally used, it's a safe assumption.

However, this does preclude a dozen of the European characters that may be used outside of the U.S., so if your code must run with non-English characters, you may want to shift the codes up a bit farther.

When **getkey()** is called, I pass it two unsigned char fields. These really are optional, but they do allow my main program to make some additional decisions about the key and scan code entered. Note that my **main()** program doesn't really utilize this capability in the sample shown.

Once in **getkey()**, I call the ROM BIOS function 16 hex, the Keyboard Service routine. Passing a value of 1 in the AH register requests keyboard input with wait. If I wanted to scan the keyboard to see whether input is available, I could insert a call using AH of 2 prior to the call shown here.

The ASCII code of the keypress is returned in the AL register, and the scan code or special key code is returned in AH. If the user presses a normal ASCII

key, the ASCII value is in AL and the keyboard "scancode" is in AH. If the key pressed is a special key, the value of AL returns a zero byte.

If the zero byte is returned, the high byte stored in AH contains a key code. By checking in the *Vectra Technical Reference Manual*, I've identified the codes of the keys I wish to process here.

The lowest key value is 59 decimal, returned for function key F1; the highest is 81 decimal, for the [PgDn] key.

To "upshift" these values into the ASCII range starting at 159, I simply can add 100 decimal to the special key value and return it as if it were an ASCII code.

As **getkey()** ends, the return value will be the ASCII code for the character entered by the user, or a code in the range of 159 to 181 signifying a special key. In **main()**, I have built a test to see if the value returned is above 158 and hence a special key; or below 158, in which case the value is an ASCII code.

If the key pressed was a special key, the switch statement will process the keycode returned and display a message telling you which key was pressed. In your application, you probably would make some decisions about program flow, or at least cursor location, based on the key values returned. Nonetheless, you can see how this will work.

The program shown was compiled using Borland's Turbo C 2.0 on an IBM-AT with 640K. It should work fine on virtually any Vectra or IBM PC clone and allow you to improve your user interface. — Miles B. Kehoe is a technical product manager for Hewlett-Packard Cupertino, CA.

Would you like to continue to see articles on this topic?
Circle on reader card
yes 330 no 329

A

Program.

```
/* Sample program to detect special key presses on Vectra
and other IBM compatibles. See notes in text about
uses and limitations of these procedures.
```

```
This code copyright (c) 1989 by Miles Kehoe. Permission
to use these samples in applications is freely granted
as long as any source code sold commercially retains this
copyright notice.
```

```
*/
/* ***** */

#include "dos.h"
#include "stdio.h"
#define INT10 0x10
#define INT16 0x16

union REGS regs;
/* ***** */
void home()
/* home - position cursor to location (0,0) */
(
    regs.h.ah = 2;
    regs.x.dx = 0;
    regs.h.bh = 0;
    int86(INT10,&regs,&regs);
)

/* ***** */
void clear()
/* clear - erase screen
uses home
*/
(
    home();
    regs.h.ah = 9; /* Write char w/ attribute */
    regs.h.al = 32; /* Space character */
    regs.h.bh = 0; /* White on black attribute */
    regs.h.bl = 7;
    regs.x.cx = 2000; /* 2000 characters */
    int86(INT10,&regs,&regs);
)

/* ***** */
void gotoxy(r,c)
/* gotoxy - position cursor to row r, col c
0 <= r <= 25
0 <= c <= 79
*/
int r,c;
(
    regs.h.ah = 2;
    regs.h.bh = 0;
    regs.h.dh = r;
    regs.h.dl = c;
    int86(INT10,&regs,&regs);
)

/* ***** */
int getkey(char *hi, char *lo)
/* get keyboard input . see text for explanation */
(
    unsigned int keycode;

    /* Set up and make INT 16 call */
    regs.h.ah = 0;
    int86(INT16,&regs,&regs);
    *hi = regs.h.ah;
    *lo = regs.h.al;
```

```
keycode = regs.h.al; /* key value */

if (keycode==0) /* special key, do mapping */
    keycode = *hi+ 100; /* add 100 shifting keycode up */
else
    keycode = *lo;
return(keycode);

)

/* ***** */
void main()
/* try out keyboard interrupt stuff */
(
    unsigned int key = 0;
    unsigned char hbyte = 0;
    unsigned char lbyte = 0;

    printf("All set to go, type away (press Ctrl-C to quit)\n");
    while (lbyte!=3)
    (
        key=getkey(&hbyte,&lbyte);

        if (key >= 159)
        (
            switch (key)
            (
                case 159:
                case 160:
                case 161:
                case 162:
                case 163:
                case 164:
                case 165:
                case 166:
                case 167:
                case 168: printf("Function key F%\n",key-158);
                    break;

                case 171: printf("Home\n");
                    break;
                case 172: printf("Up arrow\n");
                    break;
                case 173: printf("Page Up\n");
                    break;
                case 175: printf("Left arrow\n");
                    break;
                case 177: printf("Right arrow\n");
                    break;
                case 179: printf("End\n");
                    break;
                case 180: printf("Down arrow\n");
                    break;
                case 181: printf("Page Down\n");
                    break;
                default:
                    key = 0;
            ) /* switch */
        ) /* end key == 0 */

        else /* lbyte not zero, treat as normal character */
        (
            if (key!= 3)
                printf("%c",key);
            if (key==13)
                printf("\n");
        )

    ) /* end main input */

    printf("All done, thanks alot\n");
```

Shells And Special Commands

HP-UX

Andy Feibus

Before I discuss HP-UX input and output, let's first look

into shells. A shell is a program that executes commands. These commands may be either user commands (e.g., **ls** and **ps**) or special commands recognized by the shell.

With HP-UX, four shells are provided: the Bourne shell (**sh**), the C shell (**csh**), the Korn shell (**ksh**) and the Personal Applications Manager shell (**pam**). Each shell provides different capabilities for both user interaction and special commands. Refer to the *HP-UX Concepts and Tutorials: Shells and Miscellaneous Tools Manual* for more information on the capabilities provided with each shell.

The shell program indicates it is ready for a command by displaying the shell prompt. A shell prompt appears similar to a **\$**.

When you type a command, the shell interprets the command string and executes the request. If the command string specifies a program to execute, the program is loaded by the operating system and then started.

When a program runs, it is called a *process*. A process is then referenced by its *process identifier (PID) number*. When the command **ps -af** is executed, the PID number for each process is located in the second column. When using the **kill** command, the PID is used to identify which process to terminate.

Each process started by HP-UX automatically opens three "standard" files, which are described below:

■ **stdin** — "Standard input" is the location from which the program expects to

obtain input. The default location is the terminal keyboard.

■ **stdout** — "Standard output" is the location to which the program expects to route all informational messages and user prompts. The default location is the terminal screen.

■ **stderr** — "Standard error" is the location to which the program expects to route all error messages. The default location is the terminal screen (yes, visually, stderr messages are similar to stdout messages).

Unless an HP-UX user command explicitly requests a file for processing, all input for the user command is requested from stdin and all output is sent to either stdout or stderr.

An example? Type the italicized text; the computer will respond with the non-italic text. The $\wedge D$ (control-D) character is generated by holding the CTRL key and pressing the letter D once.

```
$ cat —
hello
hello
^D
$ more /etc/goop
/etc/goop: No such file or directory
```

The first command, **cat**, is a simple HP-UX user command that copies the contents of stdin to stdout. In the example, the text "hello" was entered by you (the program received this information via stdin). When you press the RETURN key, the text is displayed on the terminal (the program read the text from stdin and wrote this information to stdout). The $\wedge D$ indicates the end of the input; $\wedge D$ always is used to terminate input specified to stdin.

The second command, **more**, searches for a file that does not exist.

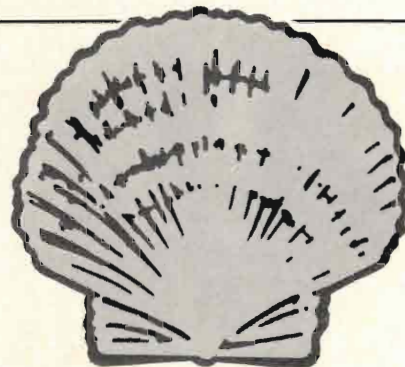

The command writes the "no such file" message to stderr, then displays it on the terminal.

As I mentioned above, each of the "standard" files have associated default locations (e.g., stdin uses the terminal keyboard as its default location); the shell provides you with a way to change these locations. The method of changing the default locations for stdin, stdout, or stderr is referred to as *redirection*, because the input or output is redirected from its default location to another location.

To specify that a program's input is obtained from the contents of a file instead of from the default location, use the following syntax:

```
$ command < file
```

where **command** is the command to execute and **file** is the file from which any requests for input from stdin are satisfied. For example, the following command copies the contents of the file **/etc/inittab** to stdout:

```
$ cat — < /etc/inittab
```

You can perform the same function without the redirection.

To redirect stdout to a file, use the

professional press publications

Today PROFESSIONAL PRESS offers four computing publications. Two are DEC oriented magazines, one magazine is geared to Hewlett-Packard, and the fourth publication is a newspaper for IBM midrange computing. Plus two important texts about C language and VAX/VMS.

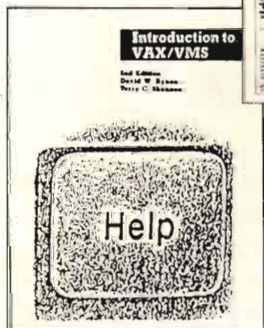
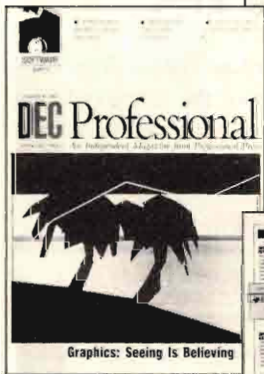

HP PROFESSIONAL

A monthly magazine written for professional users and managers of Hewlett-Packard's business/commercial and technical computer systems. With over 30,000* buyer qualified-subscribers, it offers by far the largest and most clearly targeted circulation in its marketplace.

CIRCLE 251 ON READER CARD

VAX PROFESSIONAL — The Technical Journal for VMS Systems

This bimonthly publication is the only technical journal dedicated solely to users of VAX/VMS. It's the source of practical advice on how to write better software and make better use of hardware on every VAX system.

CIRCLE 252 ON READER CARD

DEC PROFESSIONAL

The largest circulation DEC publication in existence with over 95,000 subscribers* — 100% buyer qualified* and dedicated to improving staff and equipment performance at DEC installations.

CIRCLE 253 ON READER CARD

MIDRANGE SYSTEMS — The Independent Newspaper for IBM Multiuser Computing

The only high-quality newspaper dedicated to IBM System 34, 36, 38, and AS/400 users. Its focus is on industry news and trends, new products, hardware, software, how-to features and more.

CIRCLE 254 ON READER CARD

INTRODUCTION TO VAX/VMS, SECOND EDITION

This revised and expanded self-teaching text explains and illustrates how to use VAX/VMS systems. Easy to learn for the computing novice . . . an excellent reference for VAX/VMS pros. Covers the basics and teaches systems and programming as well, plus glossary and appendices. Authors: David Bynon and Terry Shannon.

CIRCLE 255 ON READER CARD

LET'S C NOW

A complete guide to learning C language in two volumes. Over 300 pages in 26 chapters in a self-instructing workbook format. All the information needed to become proficient in C. Plus chapter summaries, glossary, and author Rex Jaeschke's hints and suggestions.

CIRCLE 256 ON READER CARD

BUY • SELL • MAINTENANCE

HP1000

HP3000

HP9000

HP Compatibles

World Class Service



World Class Savings

- SYSTEMS
- DISC DRIVES
- TERMINALS
- MEMORY
- I/O EXPANSION
- PRINTERS
- PLOTTERS

LARGE INVENTORY
GUARANTEED MAINTENANCE
BEST PRICES

COMPUTECH
SYSTEMS CORPORATION

2721 152nd Ave. N.E.
Redmond, WA 98052

(206) 883-4107
1-800-882-0201 (US)
FAX: (206) 881-2482

following syntax:

```
$ command > file
```

where **command** is the command to execute and **file** is the file to which all stdout output is routed. For example, the following command lists the files in the `/etc` directory to the file **goop**:

```
$ ll /etc > goop
```

To append the information routed to stdout to the end of an existing file, use the following syntax:

```
$ command >> file
```

For example, the following commands list the files in the `/` directory to **goop1** and then append the list of files in the `/usr` directory to **goop1**:

```
$ ll / > goop1  
$ ll /usr >> goop1
```

Redirection of both stdin and stdout may be performed on a single command (e.g., `cat<< /etc/inittab > goop2`).

To route the stdout output from one command to the stdin input of another (without using an intermediate file), use the following syntax:

```
$ command1 | command2
```

The *pipe* symbol (`|`, which is on the same key as the backslash on HP keyboards) is used to indicate that the shell should execute both commands simultaneously, and redirect stdout from **command1** to the stdin for **command2**. An example of this syntax is the following:

```
$ ll /etc | more
```

This example routes the output from the **ll** command to the **more** command, which then displays this information in a page-by-page manner.

Knowing the following HP-UX commands undoubtedly will save you

time as you continue to use HP-UX:

■ **grep** — Search for a string of characters. To ignore the upper/lower-case distinction, use the `-i` option. To only display the files in which the string occurs, use the `-l` option.

■ **find** — Locate a file based on certain file characteristics (e.g., name or last modification date). The useful options are **print**, **-exec**, **-mtime** and **-type**.

■ **spell** — Spelling checker.

■ **wc** — Counts the lines (`-l` option), characters (`-c` option) and words (`-w` option) in text.

■ **pr** — Formats text into pages with headings. The `-o` option indents the text, and the `-t` option removes the default header.

These commands obtain input either from files or from stdin. All five commands route their output to stdout (and errors to stderr). All commands are documented in Section 1 of the *HP-UX Reference Manual*.

To use the stdout output from one command as part of the command line of another command, use the following syntax:

```
$ command1 'command2'
```

The delimiters around **command2** are accent-graves (on the same key as the `¼` on HP keyboards) and not single quotes. For example, to edit all of the files in your directory that contain the string "basketball" use the following command:

```
$ vi 'grep -il basketball *'
```

The "*" is a wildcard character interpreted by the shell to indicate all files in the current directory. The shell first executes the **grep** command. The output from this command (a list of files) is then used as command line parameters for the **vi** command, which the shell then executes.

When a list of files is specified to **vi**, use the `:n` command (within **vi**) to edit the next file in the list.

Time for more examples. To perform an **ll** on each file in your directory

which has been modified within the last five days, execute one of the following commands:

```
$ find . -mtime -5 -print -exec ll {} \;
```

```
$ ll 'find . -mtime -5 -print'
```

The first command locates each file modified within the last five days and runs the **ll** command on the file (one file at a time). The second command locates all files modified within the last five days and runs the **ll** command on all files at the same time. Both commands show the same output, but the second command is more efficient.

To determine if **program** is executing on the system, execute the following:

```
$ ps -e | grep program
```

If multiple copies of program are

executing, all copies are displayed. If no copies are executing, no output is returned. If you expect that many copies of a program are executing, use the following format of this command:

```
$ ps -e | grep program | more
```

This command displays the output in a page-by-page manner. To determine the number of copies of this program that are executing, use the following command:

```
$ ps -e | grep program | wc -l
```

With the commands already discussed, you can perform some simple word processing. Use the **vi** command to create text files, the **spell** command to indicate misspelled words, the **wc** command to count words (just in case, like this article, your text must contain a certain number of words), and the **lp**

command to print your file.

While editing your text file, use the following command to view which words you may have misspelled:

```
$ spell file | more
```

If you expect that the **spell** command will not detect many misspelled words, then do not use the "**| more**" part of the command.

Finally, to paginate your text file for printing, use the following command:

```
$ pr file | lp
```

Next month I'll discuss how to set up your shell and some simple shell programming. —Andy Feibus is a software engineer for Bradley Ward Inc., Atlanta, GA.

Would you like to continue to see articles on this topic?
Circle on reader card
yes 348 no 347

It's time to get back to the basics! BASIC-CAD: For the HP 9000

So quick and easy to use even your grandma could master it within hours!



BASIC-CAD is a menu-driven, general purpose 2D design software program for the HP 9000 platform. BASIC-CAD provides an excellent, flexible drafting system designed to meet a variety of needs. Why waste \$10,000 to \$25,000 for a package too complex to be used by your employees? With BASIC-CAD, you'll be providing professional layouts, schematics, charts, floor plans and/or designs within a few hours. It delivers the power and performance for all your requirements with an easy-to-use interface, open architecture, macro commands and much more:

- Multiple line types, rectangles, circles, arcs, text, polygons and freehand.
- Cells created on-the-fly and nested in a hierarchical format.
- One hundred drawing levels.
- Labels of almost any size and shape.
- Eight colors available on every level and in any combination.
- Zoom to any magnification.

- Full 360 degree rotation of any object.
- Shrink, Pan and Overlay any combination of levels.

Helpful, Versatile

Since it's written in HP BASIC, the most powerful BASIC language available, you can fine tune BASIC-CAD to your most stringent requirements even with only a minimal knowledge of the language. Samples of typical modifications are included along with powerful macros and examples of how to write your own. As an added benefit, even the source code is provided!

To find out more about BASIC-CAD, call (818) 991-2600 and ask Grandma for a free copy of our demo disk. At a price less than \$2,500⁰⁰, you can't lose.

Order today!



Bishop Graphics, Inc.
5210 Lewis Road
Agoura Hills, CA 91301

CIRCLE 168 ON READER CARD

IMAGINE...



Three
12 PPM
Printers in
One for
Only...

\$3,990

Dataproducts

The **LZR 1230** can concurrently support up to three computer systems while simultaneously emulating an HP LaserJet Plus, Epson FX80 and a Diablo 630; eliminating the need for three separate printers.

With a 250 sheet tray; the **LZR1230** has as options a double bin cassette feeder for an additional 500 sheet capacity and a fully functional envelope feeder.

Intelligently priced consumables and a 600K page life cycle produce the lowest cost per page output available. The \$3,990 list price makes the **LZR1230** the most economic and ergonomic printer on the market.

The **LZR1230** is available from:

S/S/T

305 Broadway, NYC 10007
(212) 964-9600 Fax. (212) 233-4678

*Ask about Dataproduct's Adobe Postscript and Appletalk printer.

CIRCLE 145 ON READER CARD

HP-IB Interfaces

- HP-IB instrument & plotter interfaces for Vectra, PC, AT, 386, PS/2 & Macintosh
- HP-IB data buffers
- HP-IB bus extenders
- HP-IB converters to RS-232, RS-422, modem, Parallel (Centronics), SCSI, analog I/O, digital I/O, GPIO & BCD
- HP-IB clock and SRQ generator
- HP-IB control for Lotus 123 & Symphony

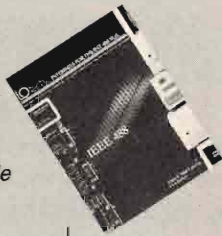

Call or send
for your **FREE**
Technical Guide

IOtech

(216) 439-4091

Telex 6502820864 • Fax (216) 439-4093
IOtech, Inc. • 25971 Cannon Road
Cleveland, Ohio 44146

CIRCLE 123 ON READER CARD

Teach Me/ 3000™

- * Train new employees on the HP 3000
- * Modules range from introductory material to system management
- * Modules on IMAGE, VPLUS, COBOL and Dictionary for the programmer
- * Less expensive than sending your staff to off-site classes
- * Better trained employees become more productive, they have higher morale
- * Improved job satisfaction leads to lower employee turnover
- * Authoring language available to write your own modules
- * Free demonstration tape available of all modules and authoring language

For more information, contact:
Innovative Software Solutions, Inc.
10705 Colton Street
Fairfax, VA 22032 U.S.A.

**INNOVATIVE
SOFTWARE
SOLUTIONS**

CIRCLE 120 ON READER CARD

NEW PRODUCTS

Continued from page 24.

FILESTAR now includes complete support for variable length KSAM files in its KSAM Copy and Reorganization functions. Rebuilding to remove deleted records and simple copies are handled quickly to relieve users of the time consuming techniques previously required for these operations. A single command reloads KSAM files, while Orion's coprocessor technique makes short work of KSAM file copies.

FILESTAR also copies, moves, purges and lists other types of files, employing easy-to-use menus that include complete on-line help facilities. Single files and complex filesets may be used for any FILESTAR function, with built-in safeguards to make it safe for inexperienced users.

FILESTAR is \$995 and includes 12 months of software support and updates. For more information contact Orion Systems Technology Inc., 325 S. El Dorado, Suite 102, Mesa, AZ 85202; (602) 894-6983.

Circle 373 on reader card

Maersk Data Makes Connection With MD-PRINT

With the new mainframe software product, MD-PRINT, Maersk Data A/S has succeeded in connecting IBM's word-processing tool, DisplayWrite/370 to Hewlett-Packard laser printers or other non-IBM high-quality laser printers. This ensures fast output at low costs.

MD-PRINT enables users of DisplayWrite/370 under CICS to print document with features such as superscript, subscript, overstrike underscore, variable line spacing emphasis and footnotes.

Another advantage of MD-PRINT is the option of using proportional fonts from the special MD-PRINT font cartridge with typographic fonts. The cartridge can be used with the HP Series II and HP 2000 laser printers for output resembling that of the IBM 3812 laser printer.

MD-PRINT is 100 percent transparent to the user. The product is priced at approximately \$11,500.

Contact Maersk Data A/S, Titangade 11, 2200 Copenhagen N, Denmark; (45) 1 83 82 11.

Circle 372 on reader card

HP Enhances Its Electronic Mail System

Hewlett-Packard has announced a new version of HP DeskManager, an advanced electronic mail system with extensive information distribution features, and an add-on product, HP DeskManager Intrinsic, for integrating applications.

HP DeskManager now includes support

for Asian, Hebrew and Arabic Languages and support for industry-standard X.400 communications via HP OfficeConnect to X.400.

Fully localized versions of HP DeskManager are available in Japanese, Chinese and Korean allowing users to have all screen text and system prompts displayed either in their local language or English. Users also can select whether to write text in English or their native language.

HP DeskManager together with HP OfficeConnect to X.400 enables organizations to communicate with external mail systems complying with the X.400 standard. Suppliers, distributors and dealers can use X.400 as their common communication standard. Companies with E-mail systems from multiple vendors can overcome incompatibility problems by using a common X.400 interface.

FANG Puts More 'Bytes' In HP Viper Card

Eventide Inc. (Little Ferry, NJ) has introduced its FANG series of memory expansion products for the HP Viper 82300A, 82300B and 82310A Language Processor cards.

The HP Viper coprocessor card allows an IBM PC-AT or compatible to emulate an HP 9000 System 200 computer running Rocky Mountain BASIC or PASCAL and function as a HP-IB instrument controller.

FANG memory products include a Chip Kit with 512K of chips needed to complete the Viper card's on-board capacity and FANG daughterboards that are available in 1-MB, 2-MB, 3-MB and 5-MB configurations. Maximum Viper memory capacity of 6-MBs offered.

FANG memory products are priced at \$375 for the 512K Chip Kit, \$700 for the 1-MB board, \$1,300 for the 2-MB board, \$1,900 for the 3-MB board and \$3,100 for the 5-MB board.

Contact Eventide, One Alsan Way, Little Ferry, NJ 07643; (201) 641-1200.

Circle 382 on reader card

Datascan To Customize Font Cartridge

Datascan has announced a service aimed at relieving the laser printer headaches for corporate data processing managers. Faced with the dilemma of trying to send huge files full of soft fonts and escape sequences over a network, many managers have resorted to changing font cartridges according to the job to be run.

Now, users of HP LaserJet and compati-

ble laser printers can select all the typefaces they want available on a font cartridge. This capability is expected to appeal to corporate users with large installed bases of laser printers. This can ensure that reports and spreadsheets developed in one division will print in a consistent format after being transmitted over a network.

The service provides the ability to select virtually any set of fonts and combine them with corporate logos, signatures, bar codes or particular graphics in a single cartridge. The fonts are all held in the cartridge for immediate use eliminating the time and memory restraints commonly associated with downloading soft fonts.

The custom cartridge services are available for use with Hewlett-Packard, Canon, Xerox, QMS, Kyocera, Mannesmann-Tally, Facit, Oasys, Ricoh and Okidata laser printers. The services also can be delivered on diskette or magtape for other laser printers including the Xerox 8700 and 9700 family. Contact Datascan Inc., One Lakeside Office Park, Wakefield, MA 01880; (617) 246-2700.

Circle 370 on reader card

E-Mail Releases

V3.0 Of Gateway/3000

E-Mail Inc. has released 3.0 of Gateway/3000 for MCI Mail and HP DeskManager, a transparent gateway interface between the two mail systems. This release includes advanced file transfer and several message handling capabilities.

Gateway/3000 can import various file formats, spanning incompatible data structures and dissimilar devices. The capability supports binary and ASCII files including files native to HP, as well as a variety of PC data file types supported by emulation software.

The file serving techniques expand the use of HP Desk as a complete mail server acting on behalf of its user agent. It includes reply and acknowledgment message options, a process handling environment, high-end volume throughput mechanisms and a system log file for message event tracking. Contact E-Mail Customer Support, 10905 Venice Blvd., Los Angeles, CA 90034; (213) 204-5540.

Circle 369 on reader card

HP Introduces 3D Graphics Workstation

Hewlett-Packard has introduced an entry level 3D graphics workstation (\$14,900). The HP 9000 Model 340SRX workstation is the first 3D workstation available for less than \$15,000 and offers better 3D graphics ap-

Why this publication and more than 1,300 others let us go over their books once a year.

Some publications, we're sorry to say, keep their readers undercover. They steadfastly refuse to let BPA (Business Publications Audit of Circulation, Inc.) or any other independent, not-for-profit organization audit their circulation records.

On the other hand, over 1,300 publications (like this one) belong to BPA. Once a year, BPA auditors examine and verify the accuracy of our circulation records.

The audit makes sure you are who we say you are. The information helps advertisers to determine if they are saying the right thing to the right people in the right place.

It also helps somebody else important: you. Because the more a publication and its advertisers know about you, the better they can provide you with articles and advertisements that meet your information needs.

BPA. For readers it stands for meaningful information. For advertisers it stands for meaningful readers. Business Publications Audit of Circulation, Inc. 360 Park Ave. So., New York, NY 10010.

 **BPA** MEDIA INTELLIGENCE

Save up to 45% on over 60 products

for the Portable Plus, HP110, Portable Vectra, and HP150

Catalog highlights:

- **The Norton Utilities** customized to the HP Portables and HP150.
- **Word Perfect**, best-selling word processor, customized to the Portable Plus and HP150.
- **The Portable Paper**, the information-packed, bimonthly newsletter that shows you how to unlock the full potential of your HP Portable.
- **Great buys on new and used HP equipment.**
- **Clear, thorough descriptions of every product.**
- **60-day money-back guarantee.**

For your free catalog, use coupon or reader card, or call:
Personalized Software
 P.O. Box 869
 Fairfield, Iowa 52556
 515/472-6330



FREE CATALOG

Yes, please send me your free catalog, "Products That Make HP Portables (and the HP150 Touchscreen) Smarter."

Name _____
 Title _____
 Company _____
 Address _____
 City/State _____
 Zip _____ Phone _____

Send to: Personalized Software
 P.O. Box 869, Fairfield, IA 52556

HPPRO8801

Temple ANALYSIS

H	DATA INPUT
U	EDITING
M	PLOTTING
A	REGRESSION
N	TRANSFORMS
I	STATISTICS
N	FUNCTIONS
T	MATH
E	CALCULUS
R	DRAWING
F	
A	
C	
E	

"The best graphical data analysis program yet"

James Associates
1525 E. County Rd. 58
Ft. Collins, CO 80524
303-484-5296

for HP9000-200/300 Basic, Basic under HP-UX

CIRCLE 184 ON READER CARD

CALLING ALL HP COMPUTING AND SYSTEMS EXPERTS . . .

Share your knowledge and expertise with colleagues and professionals through the pages of HP PROFESSIONAL. Write a story or a feature article for an upcoming issue. We'll consider all articles that focus on HP systems.

Articles must pertain to current issues, problems, challenges and opportunities within the HP computing environment. Articles can focus on applications, site preparation, programming tips and tutorials, software, hardware, database management systems, system architecture, graphics, CIM, artificial intelligence, HP peripherals, etc.

HP PROFESSIONAL pays authors an honorarium upon publication of their articles. If you are interested in writing for HP PROFESSIONAL contact:

Thomas Halligan
Professional Press, Inc.
921 Bethlehem Pike
Spring House, PA 19477
(215) 542-7008

NEW PRODUCTS

plication performance than any other workstation in its class.

Based on the high-performance MC68030 microprocessor, the HP Model 340SRX delivers all the benefits of HP's high-performance SRX graphics architecture, and it is source and object code compatible with the existing HP 9000 Series 300 computers. A broad range of MCAE and MCAD applications is available from such vendors as SDRC, McDonnell Douglas, PDA Engineering and Swanson Analysis. Other applications include scientific, animation and molecular modeling.

The workstation features an MC68030 microprocessor with an MC68882 coprocessor delivering 4 MIPS performance, 4 MB or RAM expandable to 16 MB, a 16-inch color monitor (1280 x 1024 resolution) and HP's SRX graphics subsystem. The SRX subsystem delivers industry-leading graphics applications performance and features including non-uniform rational B-splines (NURBS) with trimming and advanced hardware lighting models. The graphics subsystem can be expanded from 8 to 32 color planes and has built-in Z-buffering capability.

Computer Peripherals Introduces Flatbed Scanner

Computer Peripherals Inc., a manufacturer of enhancement products for IBM PC and PS/2 compatible microcomputers, has added a low cost flatbed image scanner offering 300 x 300 dots per inch resolution to its High Fidelity family of personal computer peripherals.

CPI's High Fidelity JetSCAN inputs standard 8½ x 11-inch documents in 10 seconds and offers 100 different printout resolution selection levels ranging from 3 dpi to 300 dpi. JetSCAN is fully compatible with IBM PC XT and AT-type personal computers.

The JetSCAN also comes configured with a versatile proprietary software package with multiple file formats that support most industry-standard desktop publishing software applications and allows up to four windows per document.

Minimum system requirements for the JetSCAN include 640 KB RAM and a 20 MB hard disc drive. JetSCAN operates at an average power consumption of 35 watts and carries a one year unconditional guarantee for parts and labor.

JetSCAN, has a suggested retail price of \$1,695.

Contact CPI, 667 Rancho Conejo Blvd., Newbury Park, CA 91320; (805) 499-5751 or (800) 854-7600.

CIRCLE 368 ON READER CARD

Commnetics Offers Communications Processor

A new stand-alone high-speed remote communications processor that can access up to six compatible databases simultaneously with one input and eliminates repetitive sequential link-ups is available from Commnetics Inc. (Westwood, MA).

The Commnetics CCN-2000 Communications Processor features Custom Application Mapping (CAM) software that lets users enter one request that is then automatically reformatted to access incompatible databases stored on up to six host mainframes. Eliminating the need for repetitive sequential link-ups to each host, the stand-alone processor does not use host I/O channels.

Accessing computers locally via a modem eliminator, leased or dialup lines and async or bisync ports, the Commnetics CN-2000 Communications Processor is transparent to host operating system and can be configured as a front end to mainframes or as a remote processor. Easily reconfigured without disrupting host software it utilizes the Motorola 68000 processor and operates under UNIX.

The Commnetics CN-2000 Communications Processor is priced from \$150,000 for a 48-user system. Literature is provided upon request.

For more information contact Commnetics Inc., 390 University Ave., Westwood, MA 02090; (617) 326-1221.

CIRCLE 371 ON READER CARD

Laser Connection Debuts SX Envelope Cassette Tray

Laser Connection, a QMS subsidiary, has introduced its new SX Envelope Cassette Tray. This automatic-feeding tray holds up to 15 envelopes and is designed to fit into the paper cassette of any Canon SX-based laser printer, including QMS KISSplus, QMS-PS 810, HP LaserJet Series II and Apple LaserWriter II printers.

U.S. list price is \$85.

Contact Laser Connection Inc., 7852 Schillinger Park West, Mobile, AL 36608; (205) 633-7223.

CIRCLE 367 ON READER CARD

Note: For more information about HP products, contact the Hewlett-Packard sales office listed in the white pages of your telephone directory.

HP CAREERS - NATIONWIDE

IS YOUR PROFESSIONAL CAREER
A PERSONAL PRIORITY?

The HP market is **HOT!!!** with too many opportunities to mention. The demand is for P/A's, S/A's, System Managers; COBOL as well as 4GL's; manufacturing and financial applications experience. When you want experienced friendly help, from someone who specializes and knows your market... ask for the best...



CALL
Diane Amos, C.P.C.

**Amos &
Associates**

633-B Chapel Hill Road
Burlington, NC 27215
(919) 222-0231

CIRCLE 217 ON READER CARD

DATA PROCESSING PROFESSIONALS

WESSON, TAYLOR, WELLS

We are a major national contract programming and consulting firm experiencing continued dynamic growth. We have numerous, exciting and challenging opportunities for individuals with AT LEAST 2 years experience in the following disciplines:

POWERHOUSE **TRANSACTION** **PROTOS**
SPEEDWARE **MM/3000** **COBOL**
MNT/3000 **CUSTOMIZER**

We offer an excellent compensation and outstanding benefit/incentive plans. Relocation assistance is also available. For more information, call our National Recruiting Manager, Paul Clifton at (800) 982-4463 or (803) 438-4843. To apply, send your resume to: **WESSON, TAYLOR, WELLS, P.O. Box 1587, Dept. P-3, Camden, SC 29202.** An Equal Opportunity Employer.



CIRCLE 229 ON READER CARD

How
you live
may save
your life.

You may find it surprising that up to 60% of all cancers can be prevented. By avoiding excessive exposure to sunlight, by not smoking cigarettes, by not overeating and by following a diet high in fiber and low in fat.
The battle isn't over but we are winning.
Please support the American Cancer Society.



**HP CONSULTANTS
& RECRUITERS!**

Advertise your services in
**HP PROFESSIONAL'S
Consultants' Directory.**

- **Reach 30,000+ HP Users** — Commercial & technical, corporate executives to technical staff.
- **High Visibility** — One page of listings dedicated to consultants & recruiters.
- **Reader Service Numbers** — Fast, accurate leads with full demographics.
- **Reasonable Rates**

Call Cynthia Leitzel
(215) 542-7008
to reserve space

RESERVE SPACE NOW!

COME TO CALIFORNIA

OCS is the leading vendor of HP 3000 data center management software. Due to our continued success, we have the following openings:

SENIOR SYSTEMS SUPPORT REP

Provide consulting, training and support to our worldwide installed base of over 4000 products. Moderate travel.

SENIOR DEVELOPMENT ENGINEER-PASCAL

Take on a full range of responsibilities from new-product concept to release. Develop scheduling, program library management and security software for MPE and MPE-XL.

SALES - MAJOR ACCOUNT MANAGER

Work in a professional environment selling our state-of-the-art products to major corporations.

OCS REWARDS CONTRIBUTION

OCS offers exceptional compensation, benefits, profit sharing and stock options, plus a unique opportunity for challenge, visibility and personal accomplishment.

Contact us in complete confidence. OCS, 560 San Antonio Road, Palo Alto, CA 94306; 415-493-4122.

HP CAREERS NATIONWIDE

It may be COLD outside, but
the HP market is HOT!

For your next career move,
call your Hewlett Packard
Specialists. We've got
positions for P/As to Systems
Managers. Your best
career move is to ...

CALL TODAY!

**JON DURRE, SARAH WILLIAMS,
or DEBBIE BLALOCK
(919) 222-0490**

**Personnel
Placement, Inc.**

P.O. Box 1815, Burlington, NC 27216-1815

CIRCLE 219 ON READER CARD

PRODUCT SHOWCASE

Font Crazy

"25 In One"

This Pacific Data Font Cartridge Includes Fonts
From All 25 Hewlett-Packard's Cartridges
**You Get 103 Fonts, 20 Symbol Sets,
13 Typefaces, 11 Sizes**

Only \$389.00

— Also —
New Toner Cartridges

at Everyday Low Prices!

92285A Toner for LaserJet &
LaserJet Plus..... **84.50**

92295A Toner for
LaserJet Series II..... **84.50**

Toner Recharging Service also Available

Toll Free: **LASER • TONE** Indiana:
800/446-5033 **812/473-5945**

CIRCLE 214 ON READER CARD

FREE! **TIME TO CALL** **ROLEX**
COMPUCHANGE

1000 • 9000 • 3000

Call for a quote and we'll enter you
in a drawing for a FREE Rolex watch.
Offer expires 3/31/89.



813/573-0330



ROLEX is a registered trademark of Rolex Watch USA, Inc.

CIRCLE 203 ON READER CARD

HP-9000

**WE STOCK A LARGE VARIETY
OF SERIES 200/300 EQUIPMENT**

CPU's **Monitors**
9920/A/U **Video Boards**
9816A/S **Interfaces**
9817A/H **Disc Drives**
9836B/C **Printers**
310's B&W, **Plotters**
COLOR

Series 80 and Series 100

CALL US TODAY TO BUY AND/OR SELL

TED DASHER & ASSOCIATES

205-591-4747 FAX 205-591-1108

CIRCLE 224 ON READER CARD

**BUY, SELL
LEASE,
TRADE.**

Hewlett Packard



23950 COMMERCE PARK, BEACHWOOD, OHIO 44122
(216) 292-0635 Fax: 216-292-4838 Telex: 205129
CRC is a Trademark of Computer Remarketing Corporation

CIRCLE 206 ON READER CARD

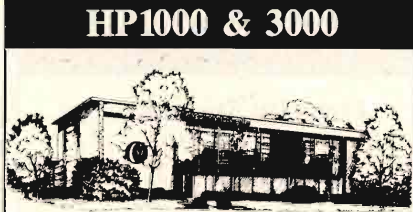

HP1000 & 3000

- BUY • SELL • LEASE • RENT
- Repair & Exchange
- \$3,000,000 Inventory
- 120 Day Warranty
- 20 Years Experience
- Hardware • Software • Service

Computer Solutions, Inc.

NJ 201/672-6000

TLX 130098 • FAX 201/672-8069

CIRCLE 207 ON READER CARD

HEWLETT-PACKARD

BUY REPAIR
and and
SELL SERVICE

ADVANT

Computer Exchange

HP Systems Specialists

US (800) 824-8418
CA (209) 823-6777
FAX (209) 823-3304

CIRCLE 231 ON READER CARD

**9-Track Tape Subsystem
for the IBM PC/XT/AT**



Now you can exchange data files between your IBM PC and any mainframe or mini-computer using IBM compatible 1600 or 6250 BPI 9-Track tape. System can also be used for disk backup. Transfer rate is up to 4 megabytes per minute on PCs and compatibles. Subsystems include 7" or 10½" streaming tape drive, tape coupler card and DOS compatible software. For more information, call us today!



9621 Irondale Ave., Chatsworth, CA 91311
Telephone: (818) 882-5822

CIRCLE 220 ON READER CARD

**BUY • SELL • TRADE
COMPLETE HP SYSTEMS AVAILABLE**

ALL PERIPHERALS

*All items in stock - immediate delivery
All warranted to qualify for
manufacturer's maintenance.*

ConAm Corporation

Canada / US 800-643-4954

California 213-829-2277

FAX 213-829-9607

RENT • LEASE

CIRCLE 208 ON READER CARD

**WE NEED TO BUY OR
TRADE FOR
HP 3000 SYSTEMS**

NO BROKERS PLEASE
CALL RICHARD



COMPUTER SYSTEMS

1101 SAN ANTONIO ROAD
MOUNTAIN VIEW, CA 94043

415-960-1010

FAX: 415-960-3474

EXCESS EQUIPMENT AVAILABLE
FOR PURCHASE

CIRCLE 233 ON READER CARD

BUY • SELL • RENT • LEASE

HEWLETT-PACKARD

Computer Equipment

9000 • 3000 • 1000

AVAILABLE FOR IMMEDIATE DELIVERY

800-422-4872
FAX 713-855-1213



TECHNICAL & SCIENTIFIC
APPLICATION, INC.

4654 Highway 6 N., Suite 101
Houston, TX 77084

"The Awesome HP Source"

CIRCLE 225 ON READER CARD

HP 3000

Buy — Sell — Trade

GUARANTEED FOR HP MAINTENANCE

C A L L

713-460-2344

(Fax) 713-460-2351

Surety
Systems

6617 Flintrock
Houston, TX 77040

CIRCLE 221 ON READER CARD

BUY • SELL • LEASE • TRADE

Preowned HP

DESKTOPS * PERIPHERALS

* TEST EQUIPMENT *

(509) 662-9039

**ELECTRONIC
SERVICES, INC.**

GUARANTEED EQUIPMENT
AT VERY

COMPETITIVE PRICES!!

FAX 509-662-8271

5187 Malaga-Alcoa Hwy.
Malaga, Washington 98828

CIRCLE 211 ON READER CARD

BUY • SELL • RENT • LEASE

HEWLETT-PACKARD

Computer Equipment
SERIES 80, 100, 200, 300, 500, 9800
ALSO

Plotters, Printers, Disk Drives
CPUs, etc...

AVAILABLE FOR IMMEDIATE DELIVERY
800-422-4872
FAX 713-855-1213

TSA

TECHNICAL & SCIENTIFIC
APPLICATION, INC.

4654 Highway 6 N., Suite 305
Houston, TX 77084

"The Awesome HP Source"

CIRCLE 226 ON READER CARD

HP-3000/HP-9000

Fidelity Systems, Inc.



LET US WORK FOR YOU

ALSO
OTC
DATA PRODUCTS
CUMULUS
TO NET

CALL

713-266-3009

BUY • SELL • LEASE

Hewlett-Packard
3000 • 1000

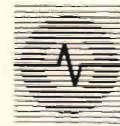

OCEONICS

Computer Products Division
1-800-727-0551
804-498-1414
FAX: 1-804-498-2432

We Buy HP 3000 - 70s.

Worldwide Offices • Premium Prices

United Kingdom

Singapore

Australia

VA Beach

Houston

Dallas

CIRCLE 216 ON READER CARD

**9000, 3000, 1000
SYSTEMS
PERIPHERALS
COMPATIBLES**

Buy • Sell • Trade
Maintenance

COMPUTECH
SYSTEMS CORPORATION

**(206) 883-4107
(US) 800-882-0201**

CIRCLE 204 ON READER CARD

HEWLETT-PACKARD

*Buy, Sell, Rent and Repair
Computers, Peripherals and Options*

★ ★ ★ ★ ★

SALES

SERVICE

(408) 270-1100

(408) 270-1170

★ ★ ★ ★ ★

FAX — (408) 270-1183

ELM — 62015192

TELEX — 9102500341

CRISIS COMPUTER CORP.

2298 Quimby Road
San Jose, CA 95122-1356

CIRCLE 209 ON READER CARD

Save up to 60%!

Top dollar when you sell!

We buy or sell any HP equipment,
including:

COMPUTER SYSTEMS • DISK DRIVES
SOFTWARE • ACCESSORIES
TERMINALS • MAG TAPES

All Equipment Guaranteed.

Specialists in hard-to-find equipment.
Immediate delivery of in-stock items.

CALL Bill Alexander at

312-916-1400

FAX 3129161361

COMPUTER MEDIA, INC.

1420 Brook Drive

Downers Grove, IL 60515

CIRCLE 205 ON READER CARD

C.S.U.
INDUSTRIES,
INC.



The second source for
HEWLETT-PACKARD
HP 9000, 3000, 1000 equipment

- Complete Configurations
- Individual CPUs — Peripherals
- Memory Upgrades and Feature Enhancements

WE BUY:
Highest Prices Paid

WE SELL:

All Items Sold Are Guaranteed for HP Maintenance
*Trade-Ins Accepted * Short and Long Term Leases Available *
Over 900 satisfied Hewlett-Packard users
are our customer references.

CALL (516) 239-4310

Telecopy (516) 239-8374

135 Rockaway Turnpike • Lawrence, NY 11559

CIRCLE 202 ON READER CARD

WE WILL PAY

**TOP PRICES
FOR YOUR
HP 9000**

SERIES 200/300
COMPUTERS, DISC DRIVES,
PRINTERS, PLOTTERS,
INTERFACES!

**ALSO SERIES 80
& SERIES 100**

TED DASHER & ASSOC.
4117 SECOND AVE. SOUTH
BIRMINGHAM, AL 35222

FAX: 205-591-1108
205-591-4747

CIRCLE 223 ON READER CARD

**NORCO COMPUTER
SYSTEMS, INC.**

*Hewlett-Packard Quality
at a NorCo Price*

1000 • 3000 • 9000 • 250

**BUY — SELL
TRADE — LEASE**
Processors, Peripherals
and Systems

925D Bassett Road
Cleveland, OH 44145-1108

FAX 2168925507

216-892-1920

1-800-892-1920
(Outside Ohio)

CIRCLE 215 ON READER CARD

INFORMATION

Rates: 1 time: \$400
 3 times: \$370
 6 times: \$340
 12 times: \$285

Size: 1/9 page — 2³/₁₆" x 2³/₄"

Typesetting and composition available.

Camera ready mechanical required.

For more information call
 Cynthia Leitzel at
 (215) 542-7008.

WHOLESALE H-P

"There's simply no reason to pay more."

2624B	\$199	7933H...	\$4,375
2392A	495	150B	275
2601A	195	2686A	895
ADCC	375	7475A	880
		RuggedWriter New	\$1,295

MICRO • 9000 • 3000 • 1000
 CAD • PARTS

Equipment Resources, Inc.

Please Call 2104 West Hills Ave.
 Mark Leonard Suite 301
 (813) 254-5948 Tampa, FL 33606
 We Buy, Sell, & Trade All HP Equipment
 Sales • Parts

CIRCLE 200 ON READER CARD

The HyPoint Advantage . . . INVENTORY

"Specializing in Full
 Line of
 HP 3000 Products"

Buy ■ Sell ■ Trade ■ Lease

HyPoint Technology
 433 E. Royalton Road
 Cleveland, OH 44147

1-800-231-5500

216-526-0323

CIRCLE 212 ON READER CARD

SOFTWARE

VT 100/102/220

Terminal Emulation/File Transfer

- For Series 200/300
- Runs Under Basic
- Very Fast



\$395.00

30-day unconditional
 money-back guarantee

SYSTEM WORKS

4318 Centennial Trail
 Duluth, GA 30136

(404) 446-6098

Preferred by major
 U.S. industries & educational
 institutions.

CIRCLE 222 ON READER CARD

IBM ↔ HP File Interchange

PCLIF is a software utility which permits the transfer of files between IBM PC's, PS/2's and HP technical (LIF) computers thru the exchange of floppy disks. Using the PC for 5.25" or the PS/2 for 3.5" transfers does not require additional hardware. An internal and an external 3.5" disk drive is available to allow the PC family to perform 3.5" disk transfers.

Innovative Software Systems
 14252 Culver Dr., Suite A-444
 Irvine, CA 92714 (714) 249-2056

CIRCLE 213 ON READER CARD

SERIES 200/300 UTILITIES VALUE-PACK™

FILE UTILITY provides wildcards to copy, catalog, or purge *multiple files* in a *single operation*. Great for backing-up hard disks, copying floppies, and general disk management. You'll wonder how you ever lived without it!

Plus SYSTEM MENU &
 TERMINAL EMULATOR

ALL FOR JUST \$145!

Runs on Basic 3.0 and up. Credit Cards &
 P.O.'s welcome. Call or write for brochure.

APPLIED MICROCOMPUTER SYSTEMS
 Page Hill Road, Chocorua, NH 03817
 (603) 323-8666

CIRCLE 201 ON READER CARD

Oswego Software, Inc.

**Hewlett-Packard
 to IBM PC
 file copy**

IBM PC,
 PS/2, IBM AT &
 Vectra can read
 & write HP ASCII,
 Binary or Series 80
 floppies. No additional
 hardware needed.

IBM PC FILE COPY . . . \$495

Call us. OSWEGO SOFTWARE
 312/554-3567 507 N. Adams St.
 FAX 312/554-3573 Oswego, IL 60543
 TELEX 858 757 U.S.A.

CIRCLE 218 ON READER CARD

Exclusive Opportunity for HP Software Vendors

3 Great Reasons to Advertise in HP Professional's Product Showcase Software Section

1. **High Visibility**
 Only software is featured in this exclusive section.
2. **Reach Buyers**
 Over 31,000 buying subscribers receive every issue.
3. **Low Cost**

Rates: 1X = \$370
 6X = 340
 12X = 285

Call Cynthia Leitzel at (215) 542-7008 to reserve space now!

ADVERTISERS INDEX

Reader Service Number	Page
102 Adager	B. Cover
185 Arkwright.....	67
168 Bishop Graphics	87
105 Bradley-Ward, Inc.....	46
180 Bradmark Computer Systems, Inc.....	5
106 Bradmark Computer Systems I.B. Cover	
108 Cardinal Data Corp.....	41
164 Collier-Jackson, Inc.....	I.F. Cover
177 Compugraphic Corporation.....	68
177 Compugraphic Corporation.....	69
167 CompuTech Systems Corp.....	86
182 Cort Directions	12
112 Dynamic Information Systems Corp.	53
113 EMC Corporation.....	9
114 Graphicus	44
115 Herstal Automation Ltd.....	72
116 Hi-Comp International	45
117 IEM, Inc.....	2
118 IMACS Systems Corp.....	11
119 Indigo Software.....	32
172 Infocentre Corp.....	19
144 Infotek Systems Corp.....	1
120 Innovative Software Solutions	88
123 IOTECH	88

Reader Service Number	Page
184 James Associates	90
173 Kelly Computer Systems.....	21
126 Martinsound Technologies	64
128 Mighty Keys	57
149 National Instruments.....	73
159 Network Research Corp.....	51
129 NSD	39
130 Orbit Software USA, Inc.....	61
131 Peripherals.....	57
132 Personalized Software.....	89
178 Proactive Systems Ltd.....	37
134 RAET Software Products.....	59
179 STR Software Company	63
145 SST.....	87
138 Tynmlabs Corp.....	6-7
140 Tynmlabs Corp.....	13
165 Tynmlabs Corp.....	55
139 Unified Software, Inc.....	60
141 Unison Software	17
187 Verilog.....	81
186 Vitalsoft	25
142 Walker Richer & Quinn.....	48-49
Westinghouse Idaho Nuclear.....	79
143 Wollongong Group.....	4

[CALENDAR]

[MARCH]

18-22: There will be an Interex Sigrapid Users Group Conference held at the Marriotts River Center, San Antonio, TX. Contact Dan Dennis, Precision Castpart Corp., 5001 S.E. Johnson Creek Blvd., Portland, OR 97206; (503) 777-3881 ext. 8630.

20-21: Symantec Corp. will sponsor a two-day workshop in San Francisco, CA for new Time Line Version 3.0 users. Cost is \$225 per participant for one day, \$400 per participant for two days. Contact Sherri Davis, Training and Consulting Division, (415) 898-1919.

22-23: Robert Lund and Associates will hold a series of HP 3000 system performance "Boot Camp" seminars entitled Taming the HP 3000, in major cities within the U.S. and abroad. Additional dates include April 10-11, 12-13, 24-25; May 18-19, 22-23; June 8-9, 22-23. For more information contact Robert A. Lund and Associates, 34130 Parkwoods Dr. N.E., Albany, OR 97321; (503) 585-3972 or (503) 327-3800.

[APRIL]

7-20: The National Computer Graphics Association (NCGA) will hold its 10th annual conference and exposition at the Philadelphia Civic Center, Philadelphia, PA.

NCGA also will host a Department of Defense (DoD) Computer-Aided Acquisition and Logistic Support (CALS) workshop dur-

ing the conference. For more information, contact Michael Weiner at 2722 Merrilee Dr., Suite 200, Fairfax, VA 22031; (703) 698-9600.

26-28: The International Association of UNIX systems users and Patricia Seybold's Office Computing Group will jointly sponsor the Executive Uniform Symposium to be held at the Santa Barbara Biltmore Resort Hotel, in Santa Barbara, CA. For further information, contact Judy Hurwitz at Patricia Seybold's Office Computing Group, 148 State Street, Suite 612, Boston, MA 02109; (617) 742-5200

[MAY]

3-5: The Southern California Regional Users Group (SCRUG) will sponsor its 1989 Technical Conference and Vendor Show in Pasadena, CA. For more information contact Karen Zimmerman, SCRUG, P.O. Box 84219, Los Angeles, CA 90073; (213) 450-3383.

30-6/2: NECRUG will hold its 10th Annual Eastern American Hewlett-Packard Users Conference at Harrah's Marina Hotel and Casino in Atlantic City, NJ. Send a \$279 check to NECRUG Inc., c/o Jeri Fuller, U.S. Mortgage Insurance Co., P.O. Box 190, Blue Bell, PA 19422; (215) 825-7760. (After 4/28 send \$319; non-NECRUG members add \$21.) For more information contact Jeri Fuller, for vendor information contact Scott Baldwin, (215) 875-5324.

ADVERTISING

**ASSOCIATE PUBLISHER/
MARKETING & SALES** Leslie Ringe
**ADVERTISING SERVICES
MANAGER** Connie Mahon
LIST RENTAL SALES Cathy Dodies
POSTCARD DECKS Mary Browarek

REGIONAL SALES MANAGERS

CANADA Helen B. Marbach

MID-ATLANTIC/SOUTH ATLANTIC

Cynthia Leitzel

MIDWEST/SOUTHEAST Peter Senft

**921 Bethlehem Pike
Spring House, PA 19477
(215) 542-7008**

REGIONAL SALES OFFICES

NEW ENGLAND/ INTERNATIONAL

Leslie Ringe

Kristina Wesslen
Account Executive

Professional Press, Inc.
238 Bedford St., Suite 3
Lexington, MA 02173
(617) 861-1994
FAX # (617) 861-7707

NORTHERN CALIFORNIA and NORTHWEST

A. G. Germano
Regional Sales Manager

Alonna Doucette
Senior Account Executive

Professional Press, Inc.
903 Sneath Lane, Suite 220
San Bruno, CA 94066
(415) 873-3368 — 3369
FAX # (415) 873-6608

SOUTHERN CALIFORNIA/ SOUTHWEST/COLORADO

David Beardslee
Regional Sales Manager

Karin Altonaga
Senior Account Executive

Professional Press, Inc.
1010 East Union Street, Suite 101
Pasadena, CA 91106
(818) 577-5970
FAX # (818) 577-0073

HP Professional

Announcing...

SUPERDEX

SUPERDEX™ adds unprecedented data retrieval speed and flexibility to the IMAGE, TurboIMAGE, and TurboIMAGE/XL database environments on the HP3000.

SUPERDEX allows multiple keys in master or detail sets, generic and partial-key lookups, wildcards, automatic keywording and keyword retrieval, transparent field grouping, sorted sequential access using concatenated keys, and dynamic relational queries across multiple fields,

datasets, and databases.

SUPERDEX adds all the features you always wished for in IMAGE, with the flexibility and power of a relational database. It is a natural, compatible extension to IMAGE, using identical intrinsics and requiring only minor program modifications.

So unlock the power in your IMAGE environment. Give **SUPERDEX** a free try today.

**SUPERDEX is a trademarked product name of Bradmark Computer Systems for the SI-IMAGE package developed and implemented by Dr. Wolfgang Matt.*

Houston 4265 San Felipe
Houston, TX 77027
(713) 621-2808

Buffalo (716) 689-6882
Cincinnati (513) 891-7867
Los Angeles (213) 432-7713



BRADMARK
Computer Systems Inc.

CIRCLE 106 ON READER CARD

What kinds of capabilities does Adager have?

Lots, of course. And how!

Adager handles database objects such as items, fields, entries, paths, security provisions, datasets, capacities, and chains.

To act upon these database objects, you specify Adager verbs such as add, change, copy, create, decompile, delete, erase, fix, move, reblock, rename, repack, report, or shuffle.

You can pile up as many objects and actions as you wish. Once you are satisfied with your specifications, you instruct Adager to **APPLY CHANGES** and it takes off with hyperspeed.

To experience the awesome power of Adager in your own computer (whether it is a venerable Series II or a fashionable Series 950), all you have to do is request your complimentary BARUG Benchmark kit.

The Adager tape. Since 1978. Nothing could be simpler.

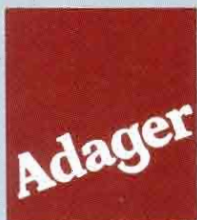

The Adapter/Manager for IMAGE/3000 Databases

P.O. Box 2358
Sun Valley, Idaho 83353
U.S.A.

From Canada and U.S.A. dial toll-free (800) LDD-REGO
From other parts of the world, dial + 1 (208) 726-9100

Fax + 1 (208) 726-8191 • Telex 40-3392 Adager • EasyLink 6289-6060

CIRCLE 102 ON READER CARD